

# Roboting:

## ***A Guide for Total Noobs***

Written, compiled, and outright stolen by Brian Gray

Lead Mentoror - Team 5256

# Table of Contents

## 1. [Wheels](#)

Some robot wheels behave very differently from those we use every day. Understanding how they work is an important first step to tackling the topics ahead

## 2. [Drivetrains](#)

An overview of Tank and Holonomic Drives, as well as their individual design variations

## 3. [Chassis Fabrication](#)

Basic chassis build types commonly found in FRC

## 4. [Materials](#)

A quick rundown of metals and plastics used in robotics and best practices to follow when choosing them

## 5. [Mechanisms](#)

Arms, elevators, lifts, and combinations thereof, used in the mid-stage area of robots

## 6. [Manipulators & End Effectors](#)

Components that interact with game elements or otherwise move things around: Claws, Hoppers, Intakes and conveyors

## 7. [Basic Pneumatics](#)

Compressed air powered subsystem operation briefly explained

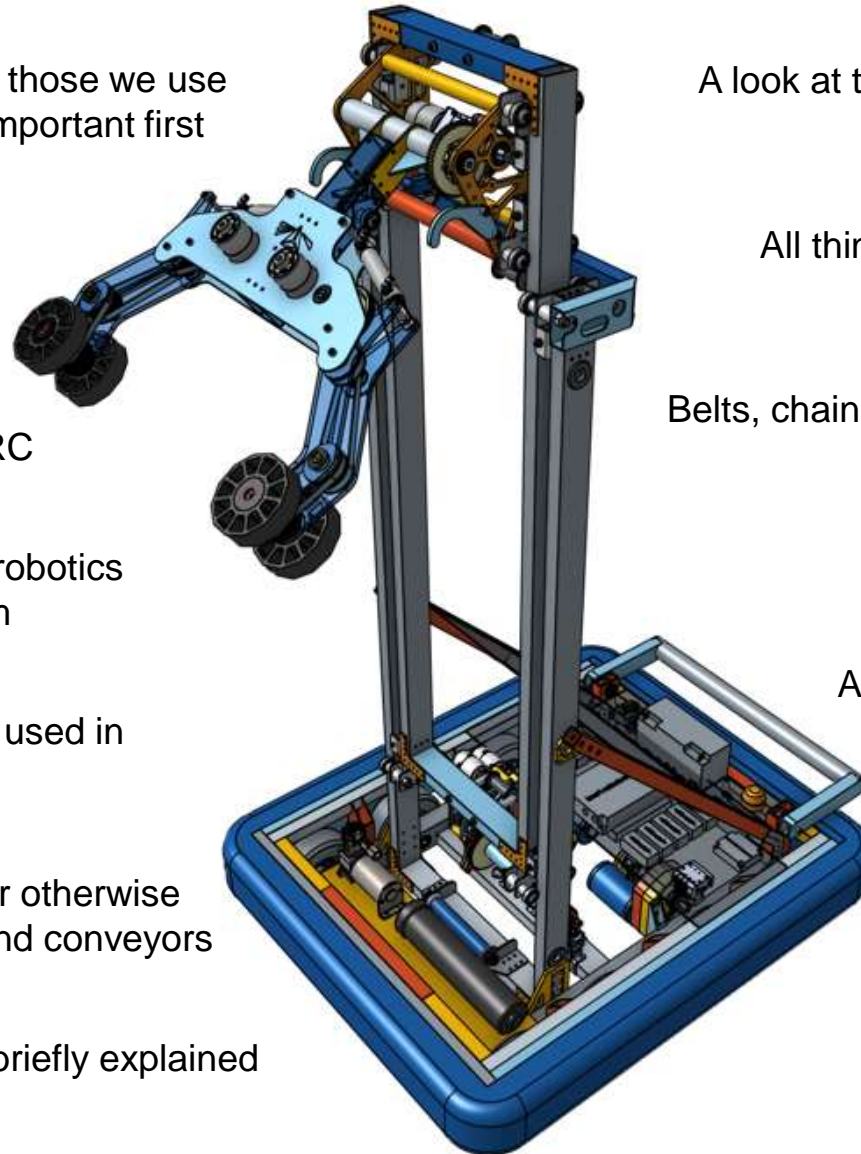

## 8. [Motors](#)

A look at the various FRC legal motors, how they work, and their pros and cons.

## 9. [Gears and Gearboxes](#)

All things gear-related: Types of gears, gear ratios, gear trains, commercial gearboxes, and more

## 10. [Mechanical Power Transmission](#)

Belts, chains, and other ways of getting power from point A to point B efficiently

## 11. [Passive & Stored Energy](#)

Utilizing and mitigating kinetic energy

## 12. [Control System Overview](#)

A brief survey of components used for autonomous operation and human-machine interface.

## 13. [Wiring](#)

Make flowing electrons work for you.

## 14. [Sensors & Inputs](#)

Using feedback and logic to control actuators

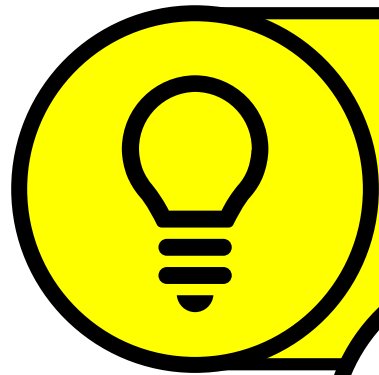

**Important Things to Know**

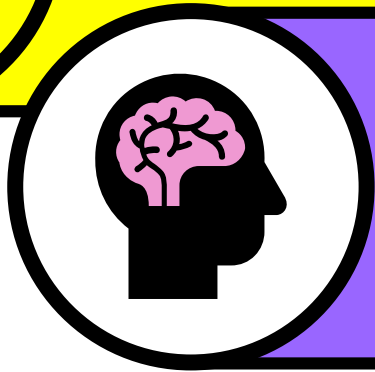

**Stuff To Think About**

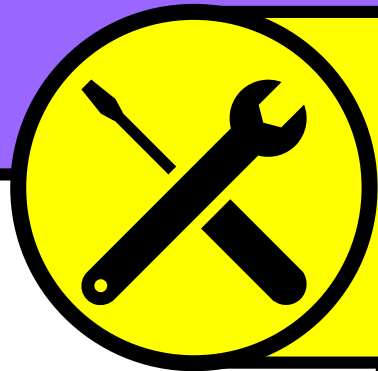

**Mechanical Skills**

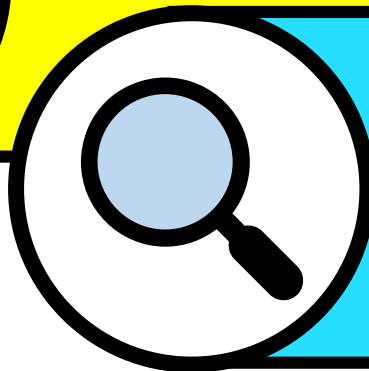

**Things to Observe**



**TL, DR**

**Helpful  
Symbols Used  
Throughout this Guide**

# Section 1

# Wheels

# Wheels

## Main Wheel Categories



Basic Wheel  
Assembly



Traction  
Wheels



Holonomic  
Drive Wheels



Other  
Wheels



# Basic Wheel **Assembly**



# Wheel Axle Components



### Hubs

Act as a linkage to couple wheels to axles, but are also used with sprockets, pulleys and articulated mechanisms.

Can be keyed, milled for a specific shaft type, or free spinning



### Bearings

Machine elements that provide for and constrain motion to rotation around a fixed axis. Bearings facilitate these tasks by minimizing friction.

Most FRC bearings are regular or flanged and have round or hex bores.

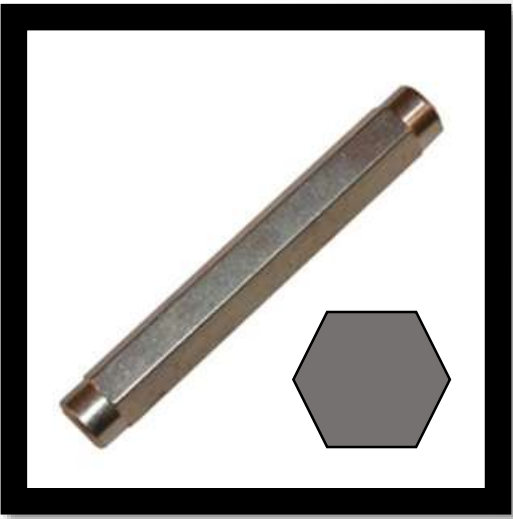

### Shafts

A fixed or rotating rod, usually round or hex shaped, with applications ranging from drive wheel axles, and gearboxes to articulated pivot points and pulley systems.

Shafts typically run through the center of hubs and bearings.



### Shaft Collar

Shaft collars, and E-clips, are handy for keeping sprockets and hubs, as well as entire shaft assemblies in one piece and positioned properly.



# Simple Wheel Assembly

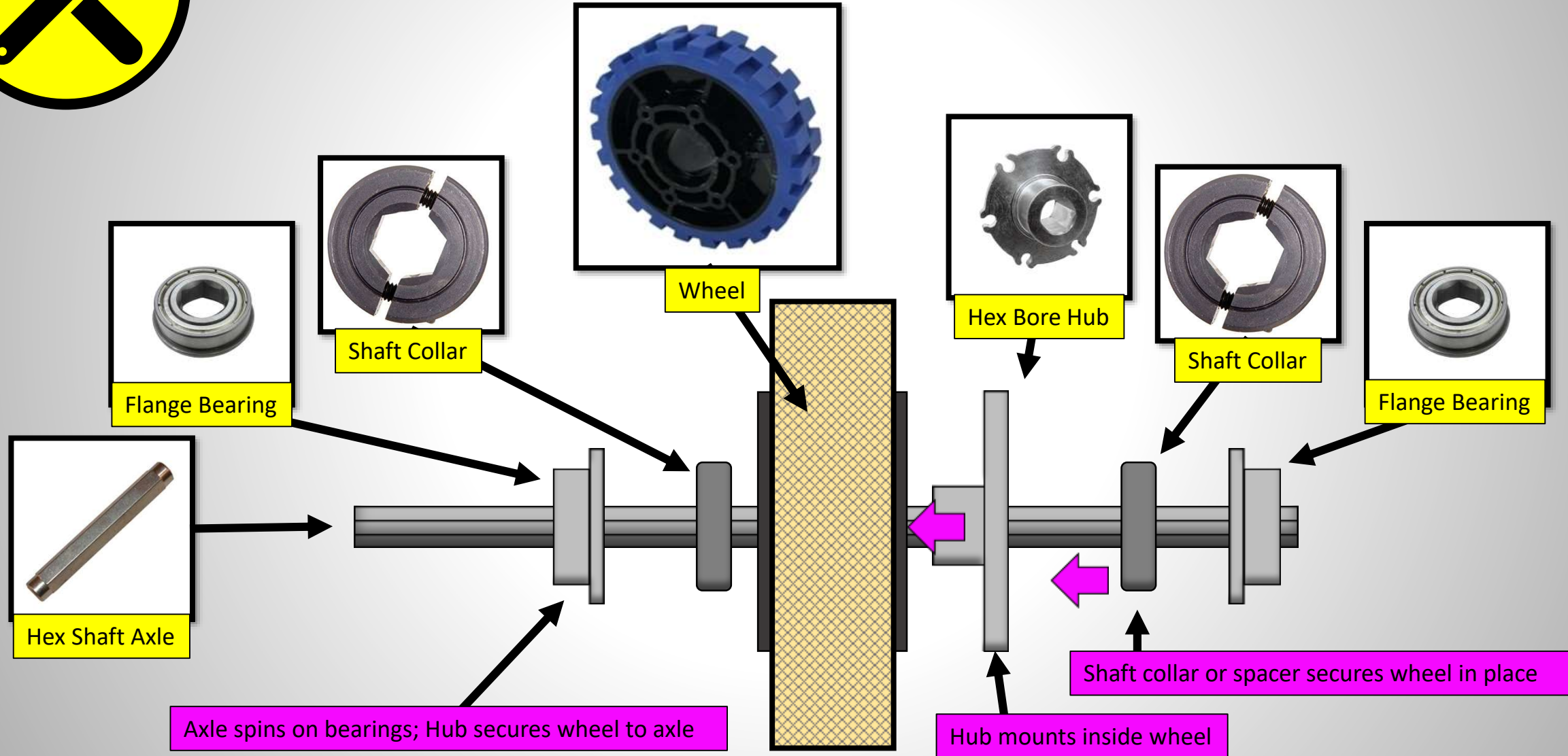





# Assembled Wheel

The example below is just to give you a very basic idea of how to put a wheel on an axle and allow it to spin freely. In the real world, design needs and drivetrain style will dictate a number of changes to this example, not to mention the addition of hardware such as spacers, sprockets, pulleys, bearing blocks.

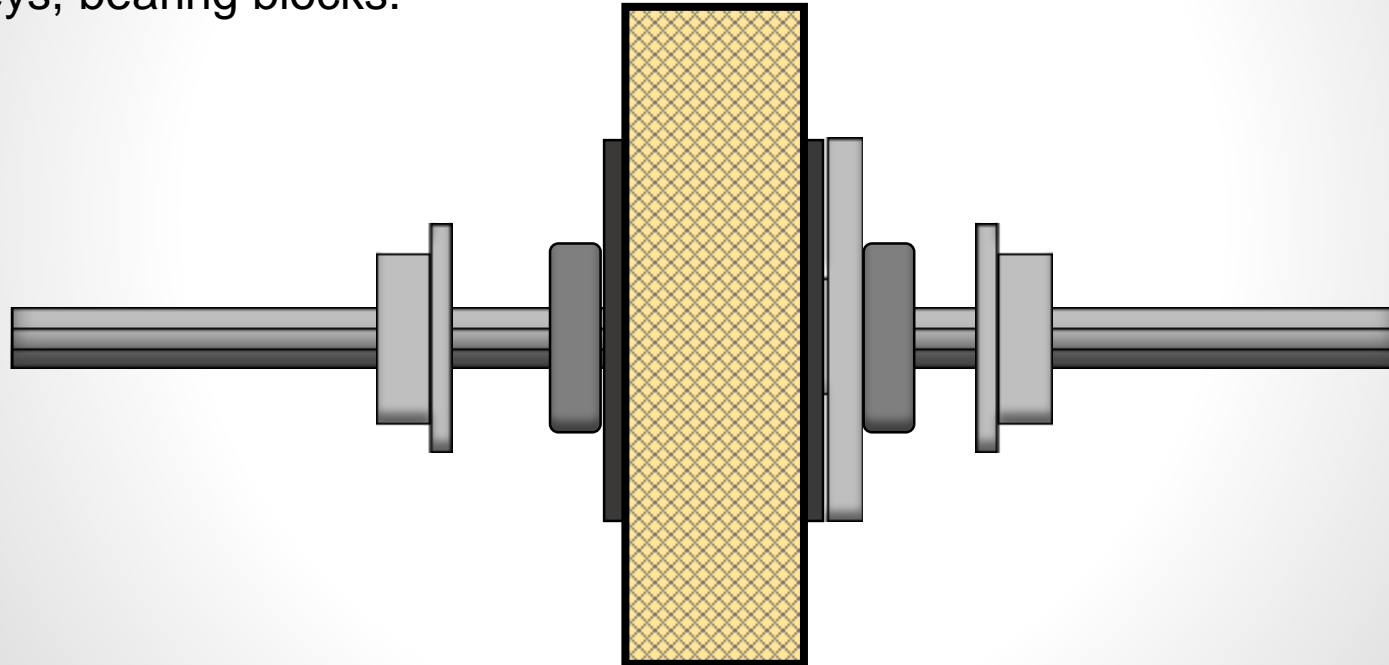

On the next 3 pages you'll find some examples of actual wheel assemblies with a corresponding graphic like the one shown above



**Example Assembly 1:  
Standard Traction Wheel  
with Belt Pulley**

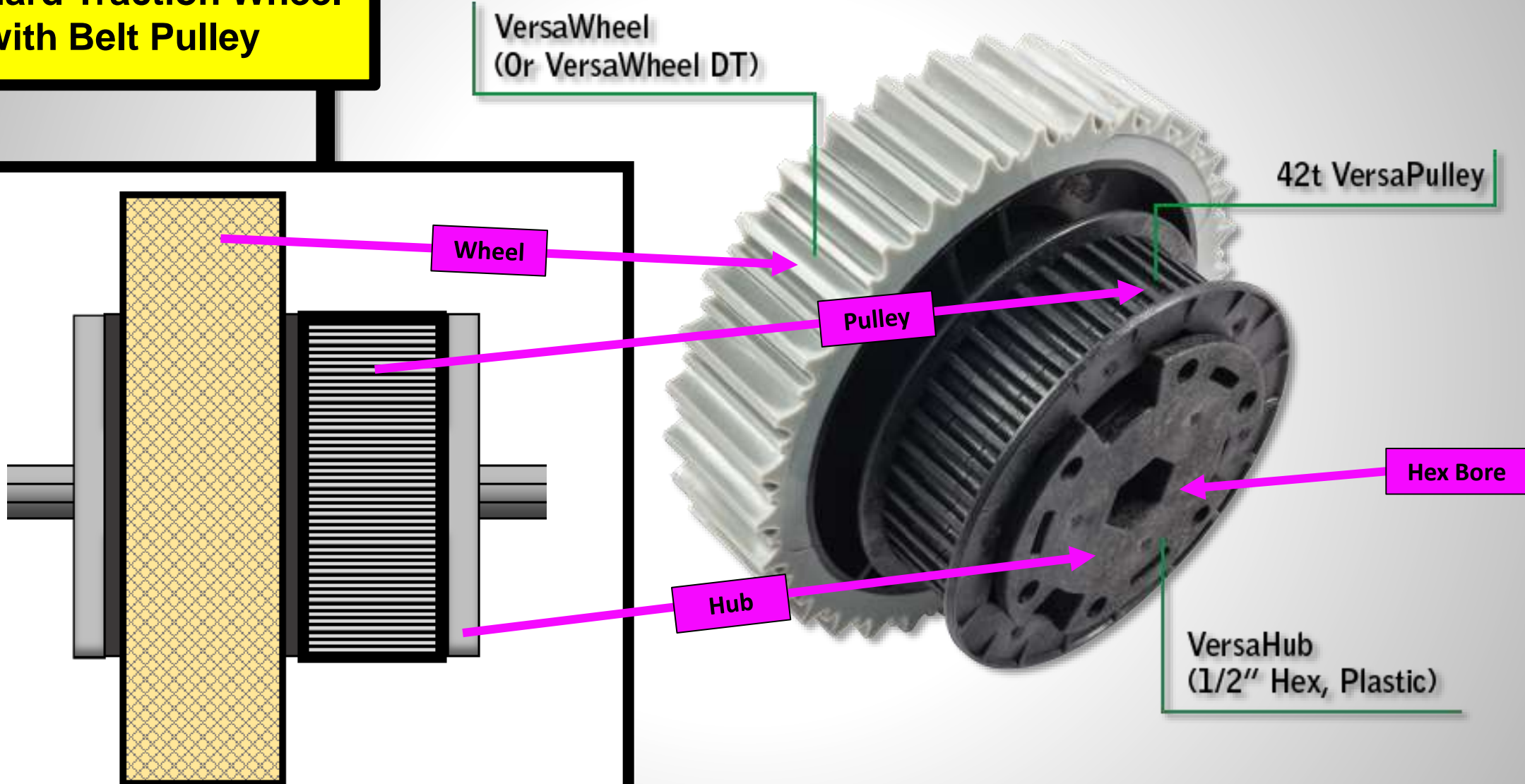

**Example Assembly 2:  
Colson Wheel  
with Roller Chain Sprocket  
on Hex Shaft**

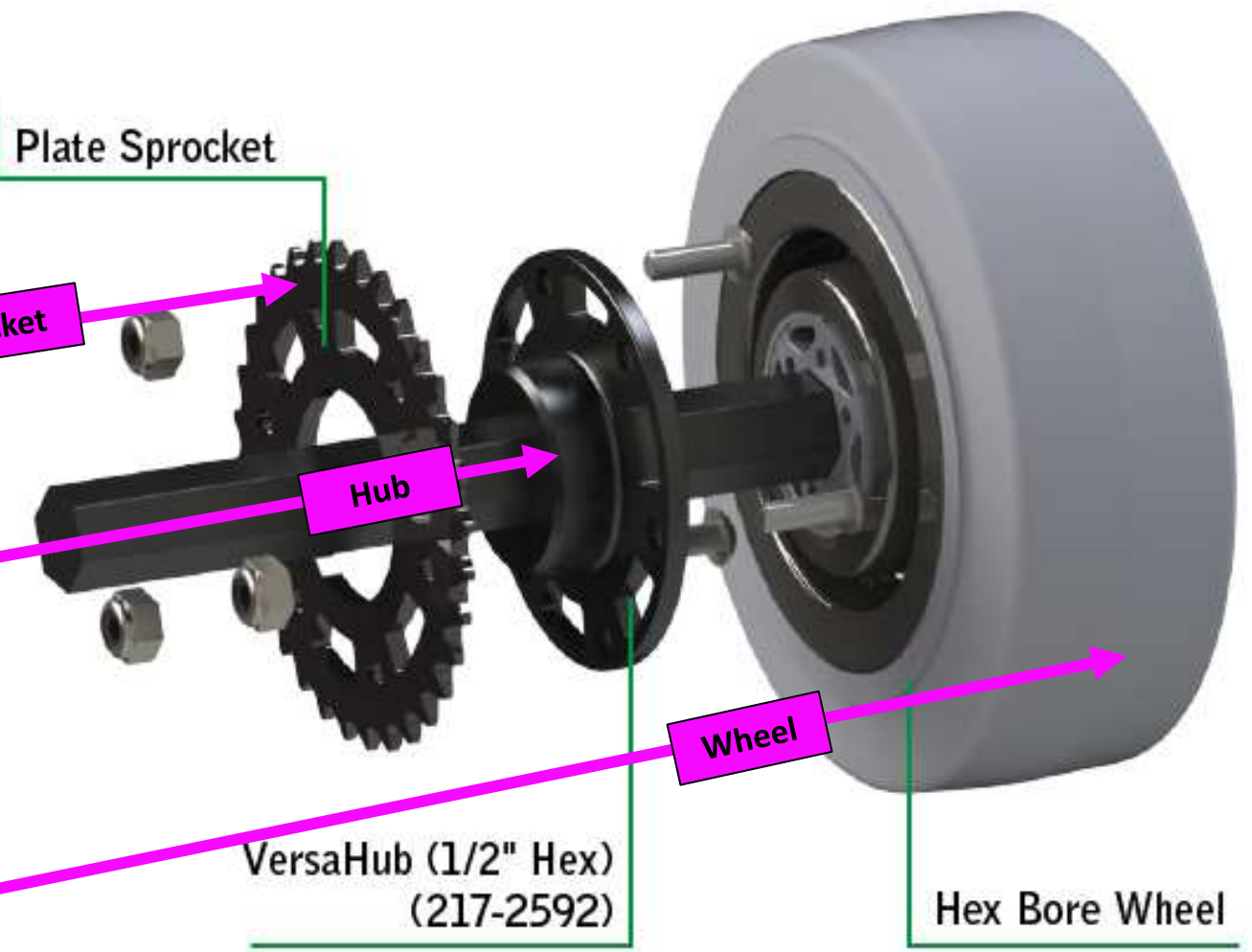
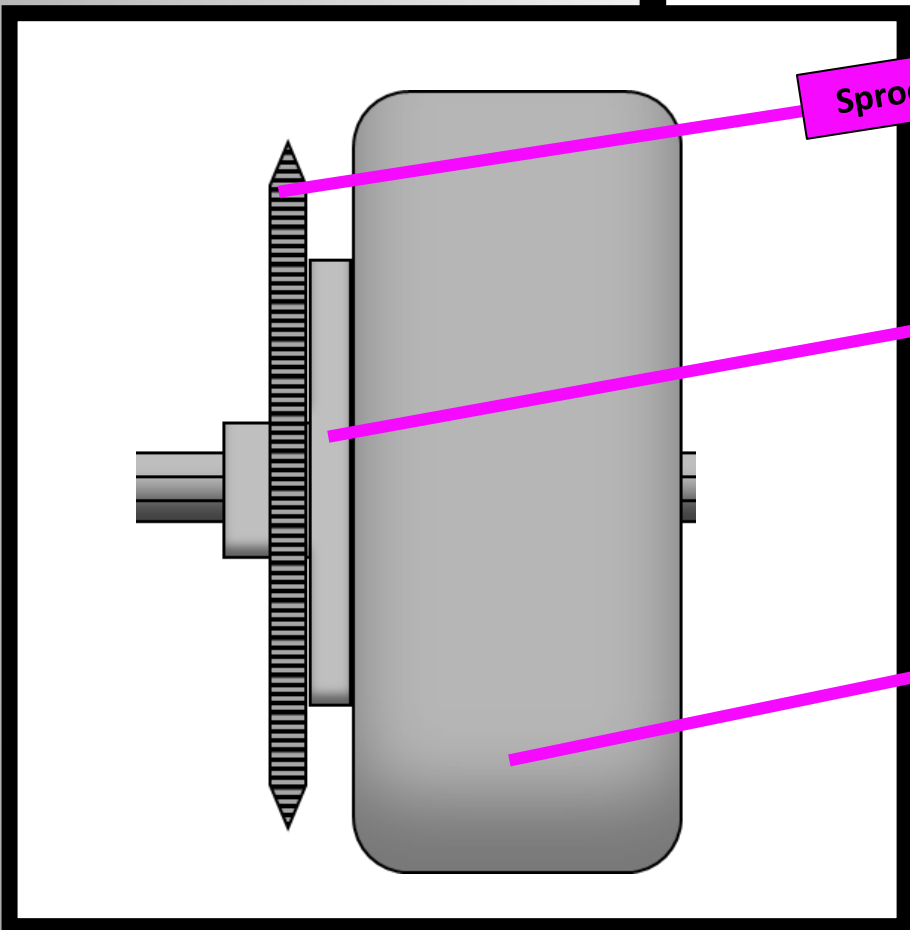

**Example Assembly 3:  
VexProTraction Wheel  
Mounted Directly on Spur  
Gear**

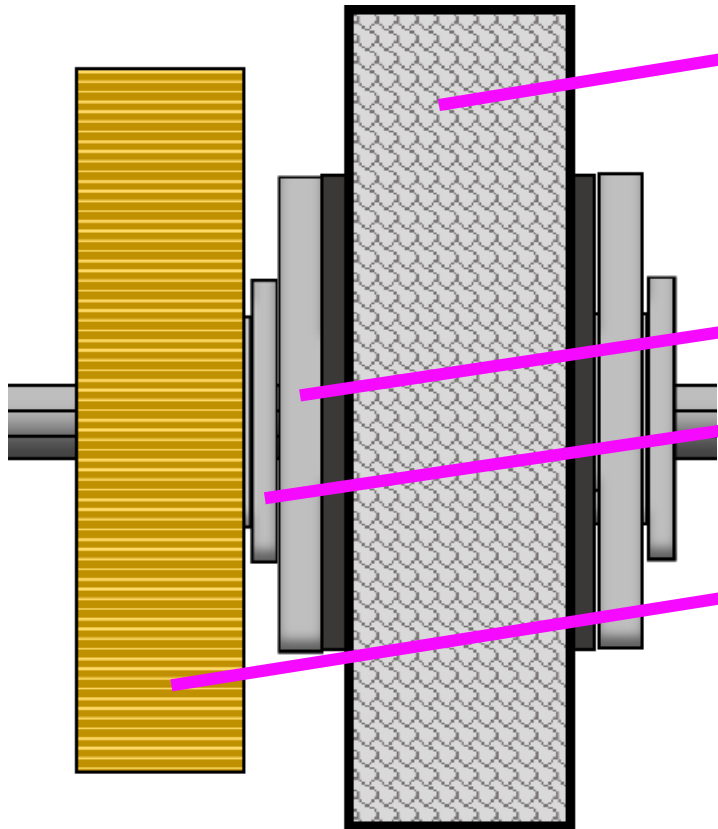

Wheel

Hub

Flange Bearing

Gear

Traction Wheel and Tire

1.125" Flanged Bearing

Gear with VersaKeys

1/4" Sprocket  
Mount VersaHub  
(217-3234)

Replaceable  
wheel tread  
(More info  
on next page)



# Axles & Bearings

Wheel axles need 2 points of support. In the examples shown, we see axles supported on both ends with the wheel in the middle. The Kit of Parts (KOP) chassis, or the TileRunner (below, left) have a wheel channel with walls designed to support axles at their endpoints. While this is common, it's not the only way to provide 2 points of support.

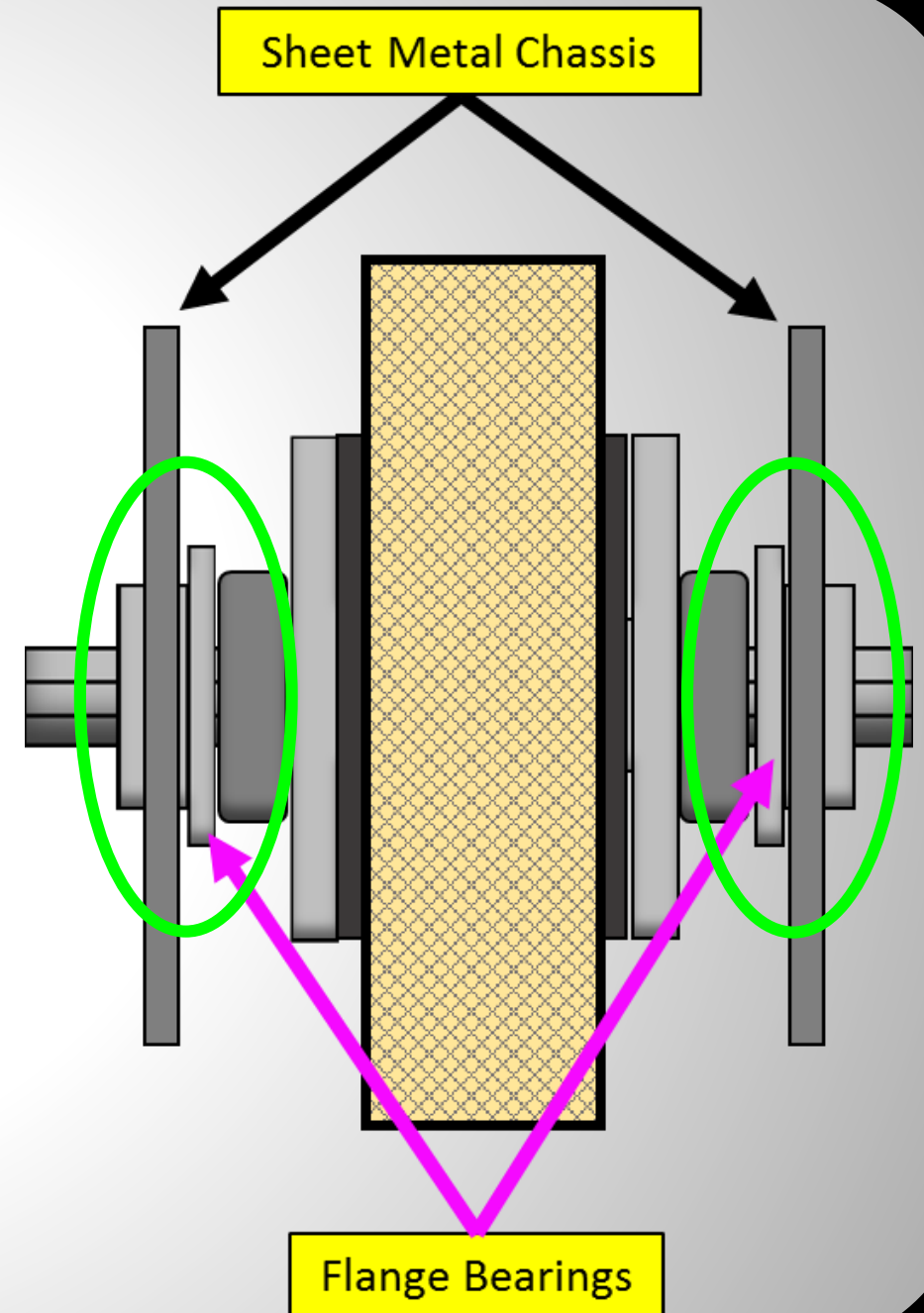



## Dead Axles

A stationary axle, such as those using bolts in the illustrations shown below, are said to be dead axles. While this type of axle does not rotate, a wheel mounted on it spins independently and is usually driven by a chain, belt or sometimes direct gearing. With dead axles the bearings are mounted on the wheel hubs, providing 2 points of support.

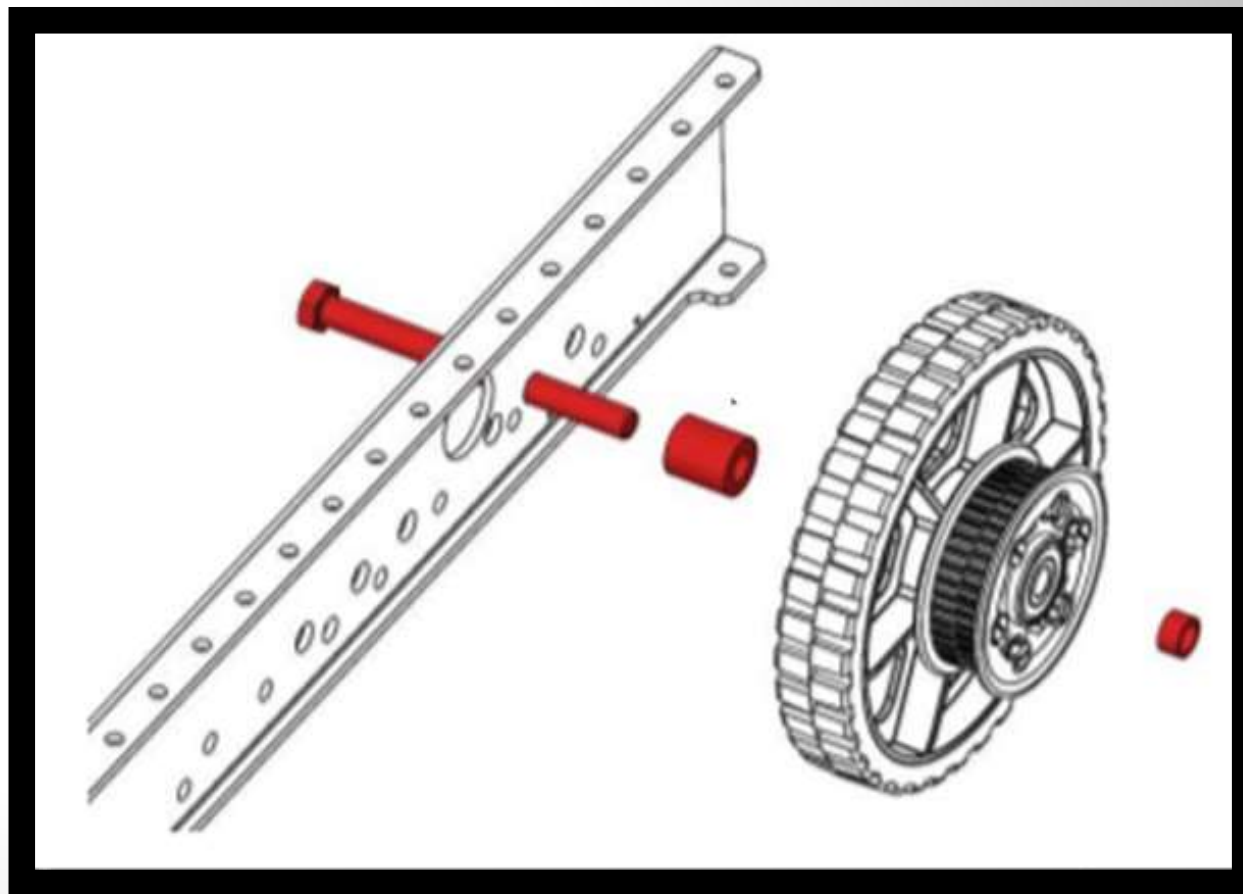
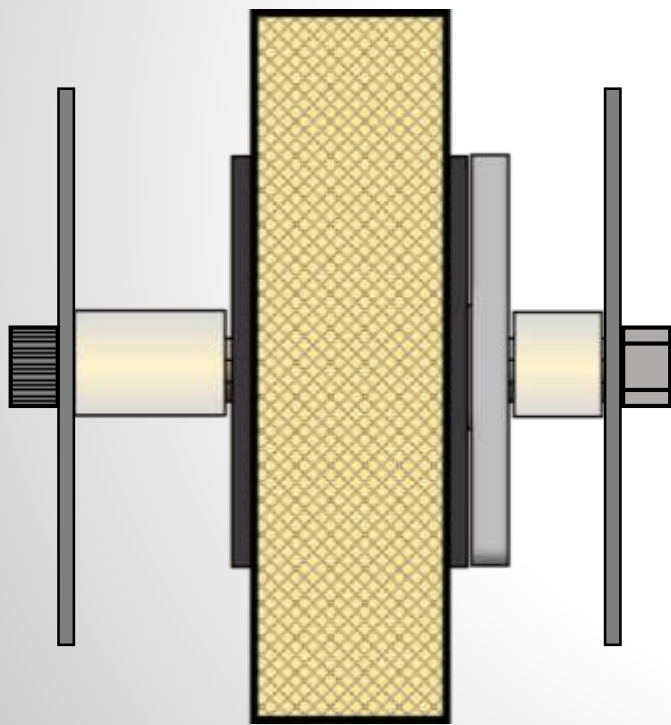

LIVE

## Live Axles

A rotating axle is referred to as a Live Axle. Wheels mounted on live axles do not spin independently and their hubs do not have bearings. This configuration is most commonly found on drive wheels, like shown below, and drivetrains using bearing blocks.

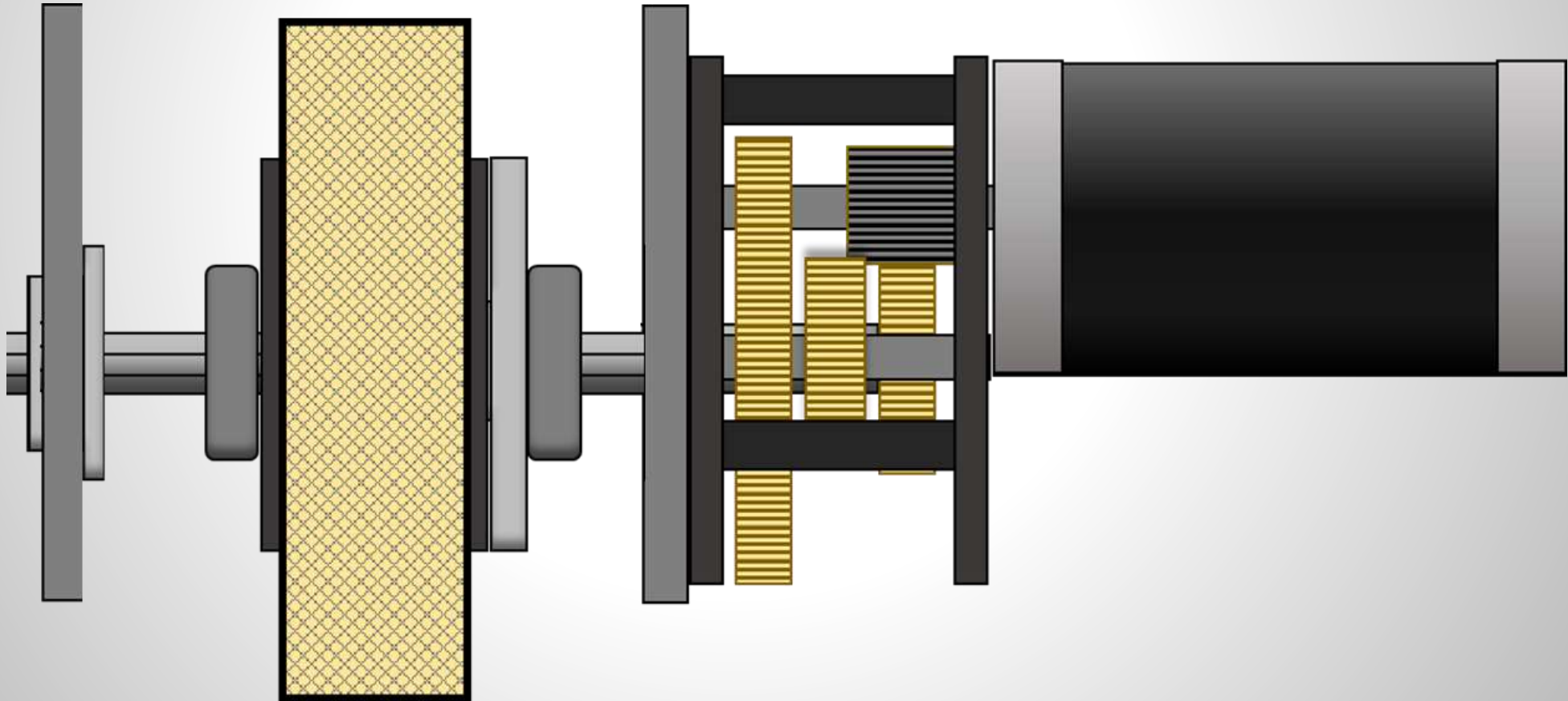



# Axles & Bearing Blocks

Meet the West Coast Drive, a chassis built with aluminum tube featuring cantilevered wheels exclusively mounted on live axles. Like the KOP chassis it provides 2 axle support points, but this time the wheels are not located in between them. The secret is in the Bearing Blocks: Sturdy, bolt-on assemblies designed to provide 2 secure support points for each wheel axle.



Bearing Block & 1x2 Tube

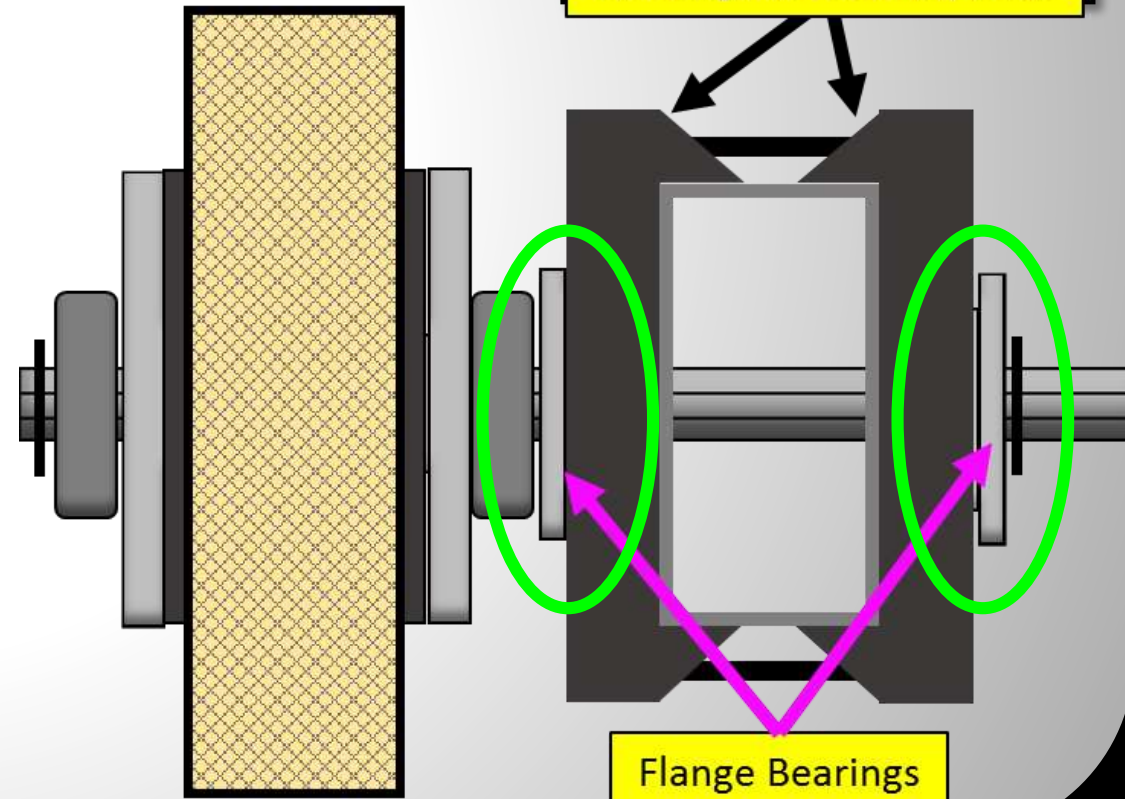
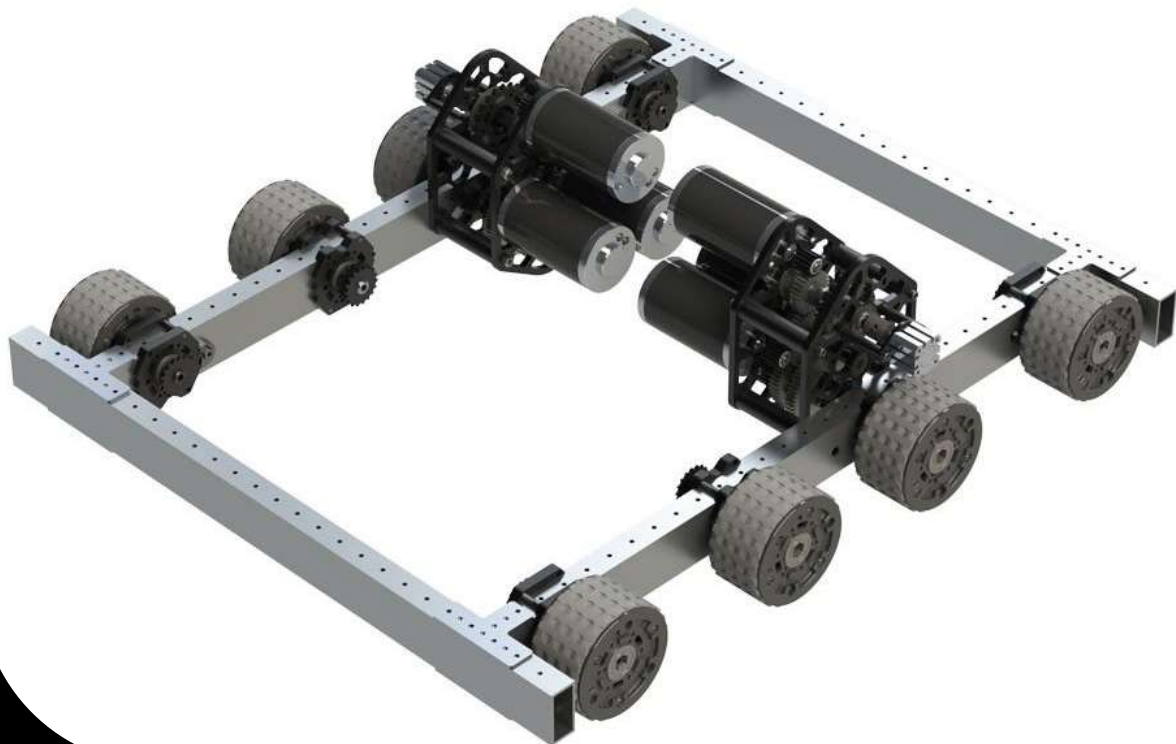

Flange Bearings





# Live Axles and Dead Axles in the Wild

The 3 examples shown below illustrate the prevalence of axle types found in common FRC chassis/drivetrain types.

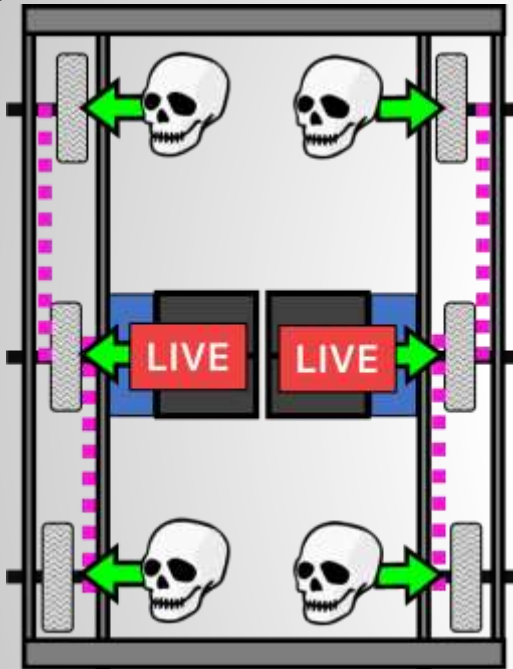

## Kit of Parts Chassis

Powered center Live Axles drive outer wheels on Dead Axles

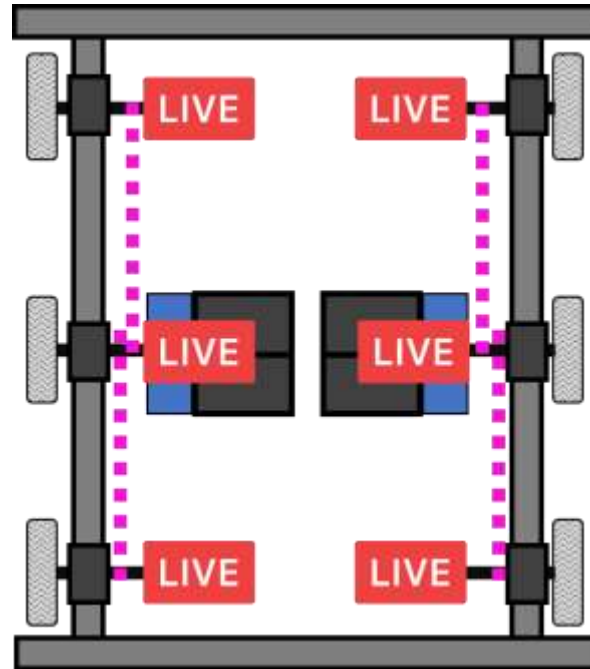

## West Coast Drive

Powered center Live Axles drive outer Live Axles

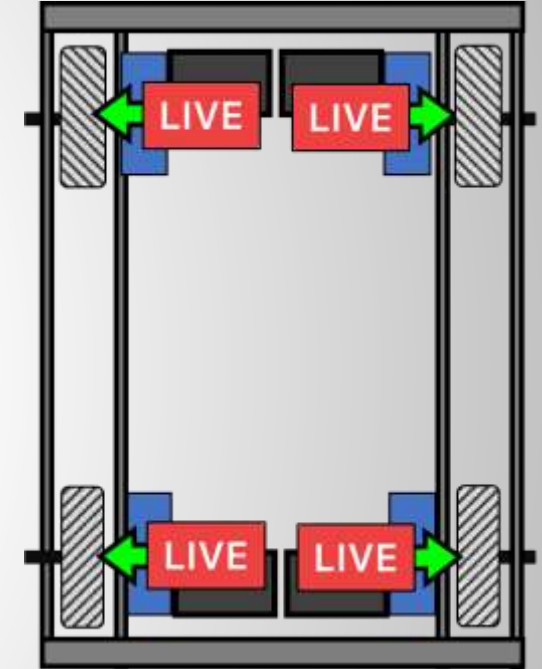

## Mecanum Drive

Four independently powered Live Axles

\*In before anyone starts talking about self-driven Mecanums on dead axes...

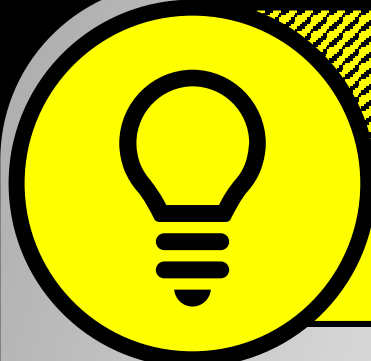

# Wheelbase & Track Width

Wheel base and track width affect maneuverability and stability greatly. Finding a “sweet spot” is key.

**Wheelbase:**  
The distance between the front and rear axles

Longer wheelbases may be prone to wheel scrubbing and, in some cases, increased likelihood of tipping

Wider may track width may result in maneuverability issues, particularly when rotating

**Track Width:**  
The distance between the center of two wheels with the same axle position.

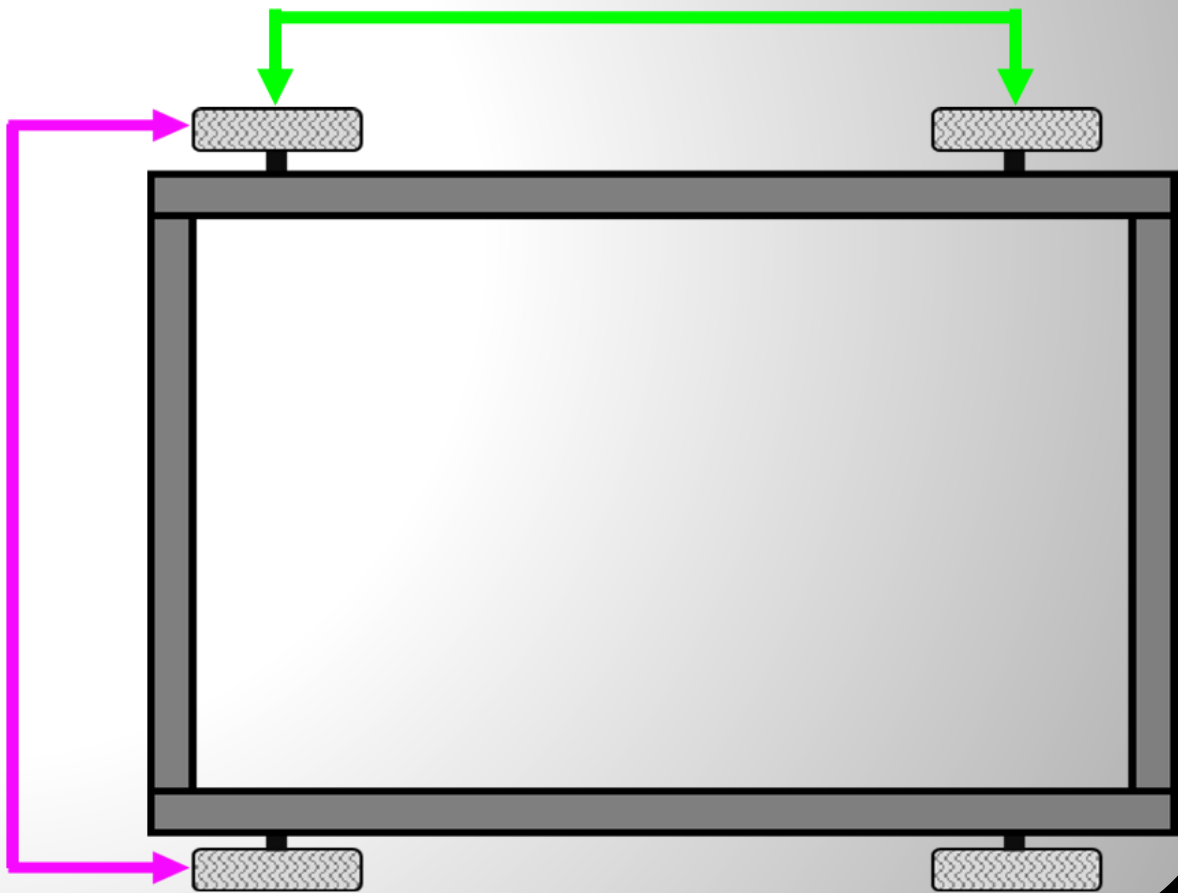



# Traction **Wheels**

Circular components intended to rotate on an axle for the purpose of facilitating locomotion

# Wheels

## Standard Traction Wheels

(AM HiGrip, Vex VersaWheels)

Low-cost, no-frills traction wheel.

### Pros:

Preassembled, one-piece, cheap.

### Cons:

Junk when tread worn; Average performance.



AndyMark Hi-Grip Wheel



Vex VersaWheel

# Wheels

## Industrial Caster Wheels (Colson)

High quality traction wheel with durable tread life.

### Pros:

Solid material continues to provide excellent traction even when surface is worn; Smaller wheel diameters provide lower center of gravity.

### Cons:

Some styles may require custom machining or rework to fit.



Colson Performa 2x4 wheel

# Wheels

## Pneumatic

(AM 8" Pneumatic Wheel)

Traction wheel designed for power scooters and wheelchairs; Good speed over rough terrain.

### Pros:

Aggressive on obstacles, big, some adjustability by varying inflation.

### Cons:

Hard to assemble; Valve stem can cause wobbling; Tires can go flat



8" Pneumatic Wheel with hub assembly

# Wheels

## Customizable Tread

(AM Performance Wheels, AM Plaction Wheels)

Traction wheel rims for replaceable tread.

### Pros:

Custom tread available in various materials/patterns;  
More consistent performance if maintained;  
Durability.

### Cons:

Tread can come loose, resulting in extremely poor traction; Aluminum wheels expensive.



Performance wheel with Roughtop Tread installed.



Tread wear after 25 matches

**ATOMICS**  
5256

# Wheels

## Replaceable Tread

**Green Grippy**



**For Intakes and Conveyors**  
Intended for use with smaller FTC-type wheels, intake rollers, or as part of a conveyor system.

**Nitrile Roughtop**

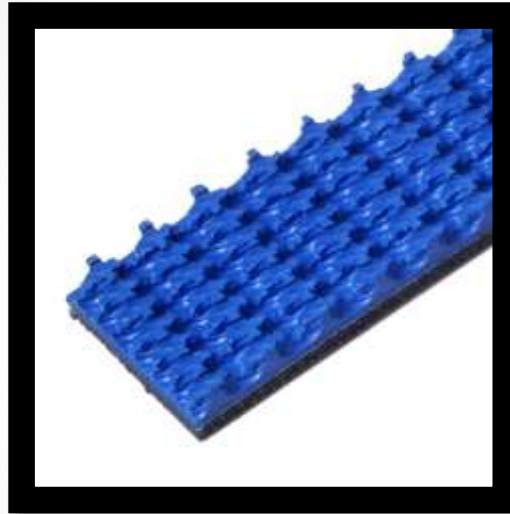

**Excellent Durability**  
Pairs excellent wear characteristics with great traction on tight pile carpet.

**Pebbletop**



**Reduces Scrubbing**  
Great traction on carpet in forward/reverse, reduced coefficient of friction when moving sideways in turns

**Wedgetop**



**Superior Traction**  
A soft, rubbery tread that requires no break in period, but tends to wear quickly and must be maintained.

**These are just a few common types, but teams are free to use any material as long as it doesn't cause damage to the field, it's elements, or game pieces.**





# Holonomic Drive **Wheels**

Wheels with the capability to be utilized for  
omnidirectional movement

# Wheels

## Omni

(AndyMark/Vex Omni Wheels)

Wheels with casters mounted around its circumference to allow lateral movement.

### Pros:

Fully omnidirectional in holonomic drives;  
Reduces wheel scrub in regular drives.

### Cons:

Vulnerable to defense; Poor traction  
compared to other wheel types.



Vex 6" Omni-Directional Wheel

# Wheels

## Mecanum

(AndyMark/Vex Mecanum Wheels)

Vectored wheels for omnidirectional movement.

### Pros:

Full omnidirectional movement at a relatively low-cost.

### Cons:

Vulnerable to defense; Inefficient due to low coefficient of friction.



AndyMark 6" SR Mecanum wheel set



# Mecanum Wheel Motion

## Force Vector

Mecanum wheels have a tread face comprised of barrel-shaped rollers which are oriented at a 45° angle. This causes them to exert a force vector indicated by the arrows in the photo shown at the right. Mecanum wheels must be placed on a robot in the right way because each set of wheels is actually made up of 2 pairs with different roller angles,

The photo at right shows the forces created when the wheels are moving forward. Each wheel creates a force that both matches and opposes those next to it. When this happens, the opposing forces cancel out, leaving the common force as the only remaining option, which in the example is to move forward.

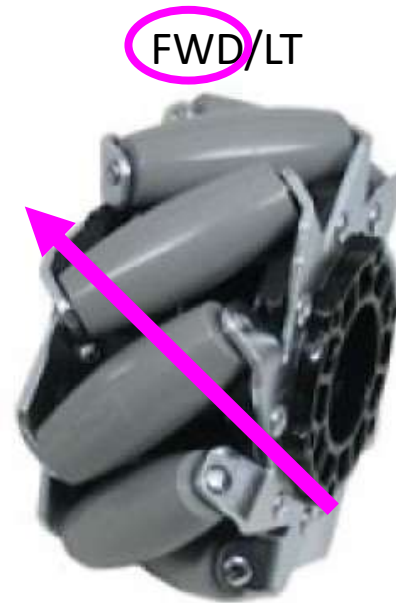
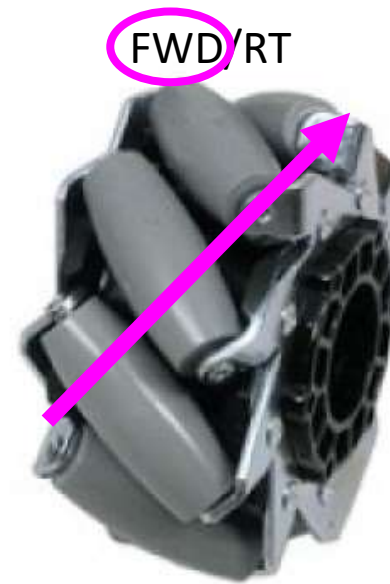

Think of each wheel as moving in 2 directions at once. Movement is determined by the common direction shared by all 4 wheels. In this case, the robot is moving forward.



# Mecanum Wheel Motion

## Strafing

The way we achieve strafing with Mecanum wheels is by having all of the arrows face to the side, which is to the left in the photo shown at right.

Bearing in mind each wheel exerts forces that are both common and opposite of their neighboring wheels, 2 of the 4 wheels must change direction in order to achieve sideways movement. To strafe left we would have to reverse the left-front and right-rear wheels. To go right, the opposite must be true.

One thing to note, is that if distribution of weight is uneven, control in all directions will be adversely affected. This is also true if a motor or gearbox is present.

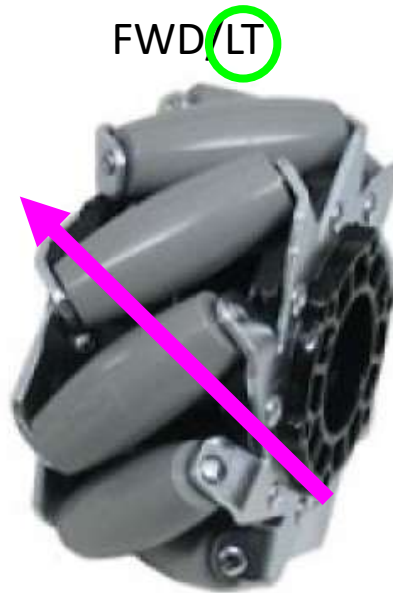
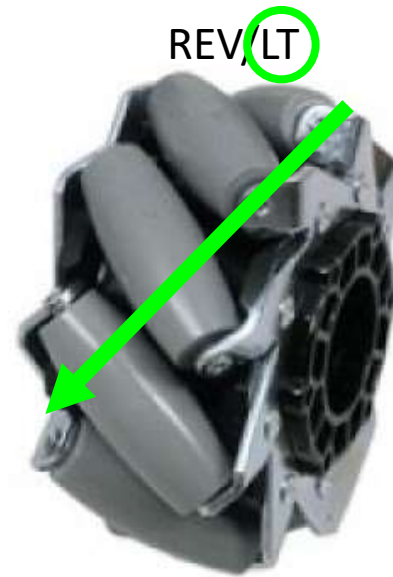

In the above scenario, the front left & right rear wheels are going in reverse, while the others continue forward. Looking at the common direction, we can see the robot will now move left.



# Other **Wheels**

Miscellaneous spinning friction devices that do not fall into the aforementioned categories

# Wheels

## Compliant Wheels

(AM Compliant Wheels, WCP Flex Wheels)

Used for intakes and other mechanisms designed to pick up or transfer objects.

### Pros:

Conforms to accommodate objects of varying size and shape; Designed with different material durometers to match intake/conveyor RPM.

### Cons:

Not designed to be used for drive wheels;  
Loses effectiveness when dirty.

Assorted compliant wheels



# Wheels

## Ball Casters

Mostly for small robots and industrial conveyor systems.

### Pros:

Omnidirectional; Easy install.

### Cons:

Mostly for FTC-sized robots or smaller; More prone to getting hung-up going over uneven surfaces than wheels; Expensive in quantities needed for conveyors; Typically cannot be driven (at least not easily).

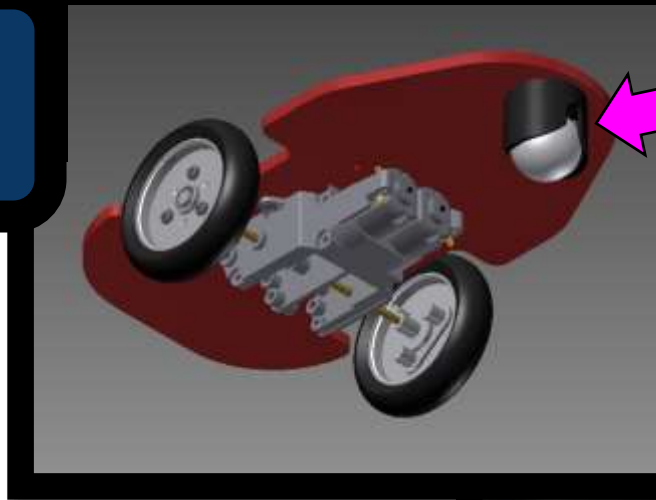



# Wheels

## Continuous Tracks (AM Rhino Track Drive Module)

Superior on rough terrain and slick surfaces.

### Pros:

Most aggressive on obstacles, can handle most surfaces. Good weight distribution.

### Cons:

Slow, heavy, complicated, expensive, failures likely crippling, repairs can difficult. Can get trapped in ruts.

2 AndyMark Rhino Track Drive Modules

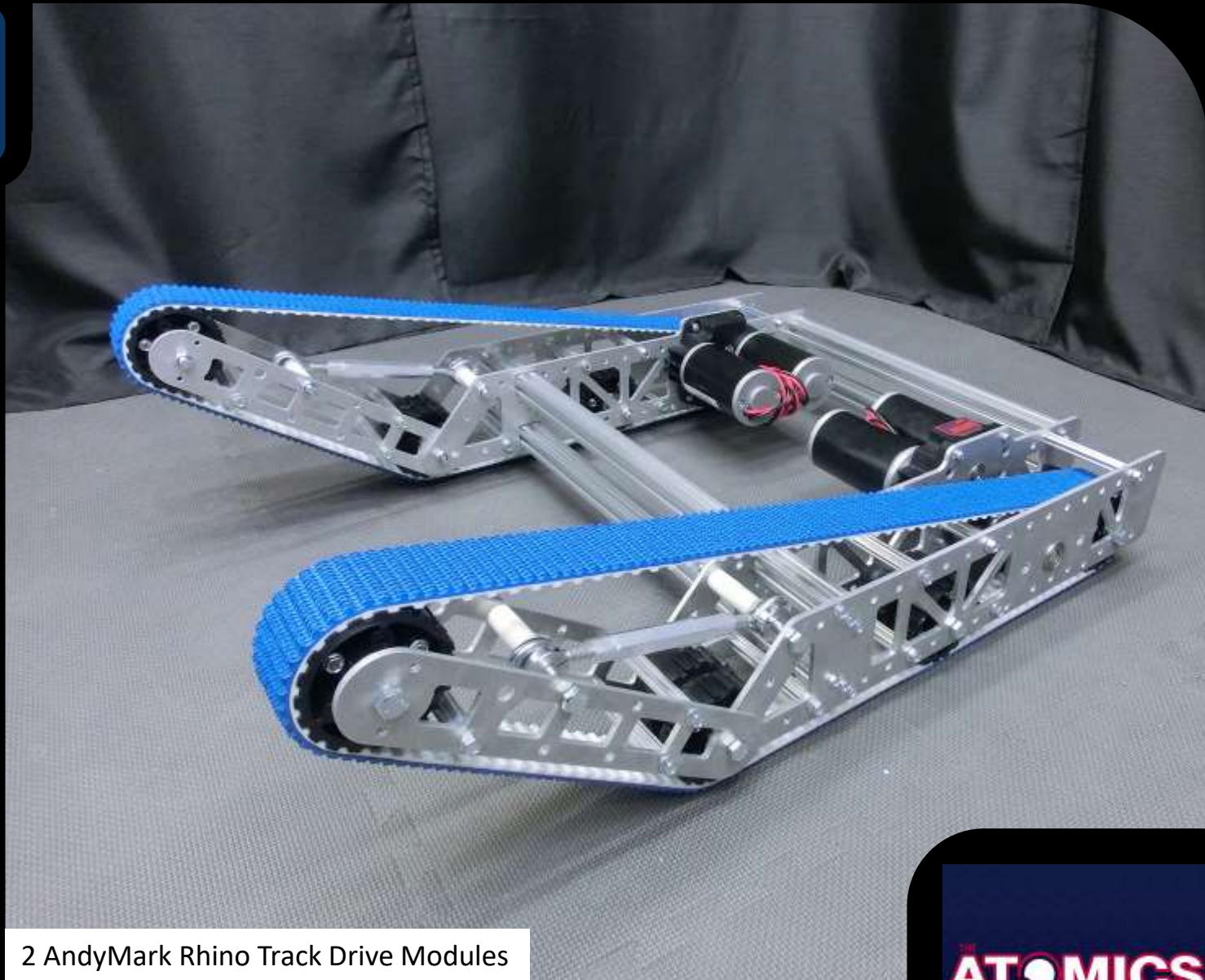



# Rhino Track Drive Modules

Tanks Do Have Wheels! Continuous track is a system of vehicle propulsion in which a continuous band of treads or track plates is driven by two or more wheels. Using the AndyMark Rhino Track Drive as an example in the graphic below, we see that the module features a powered drive wheel, two road wheels, and an adjustable tension wheel to ensure the tread stays in place

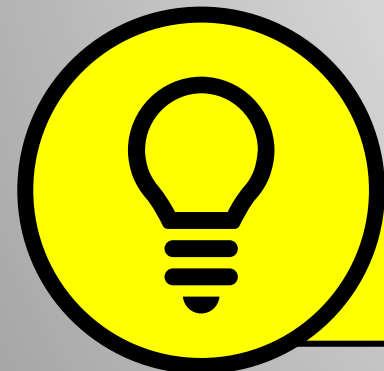
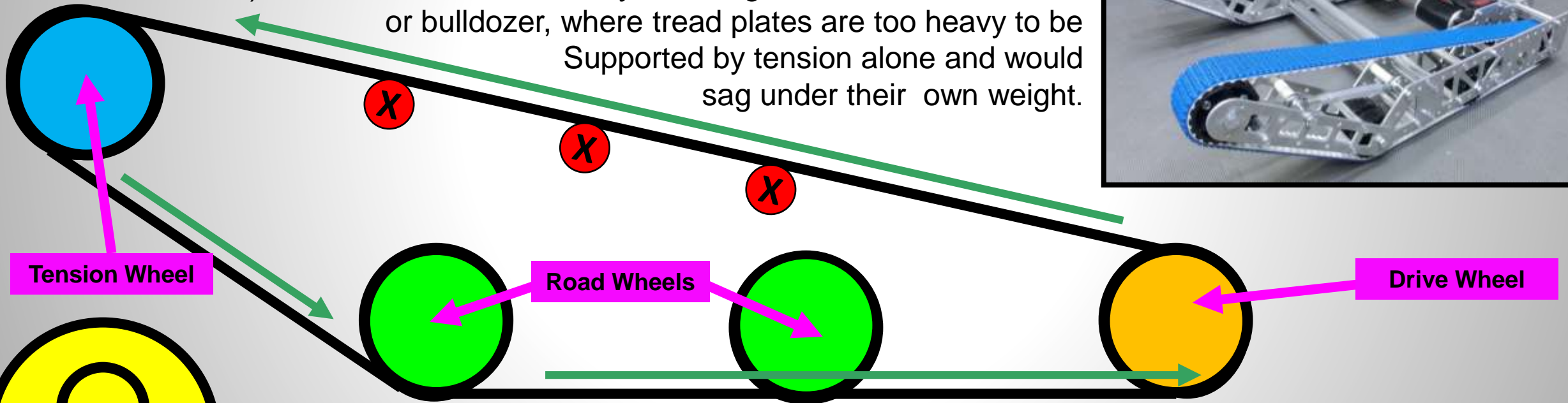

Notably absent from this example are return wheels (shown at left with red X's), which would be necessary on a larger scale, such as a tank or bulldozer, where tread plates are too heavy to be supported by tension alone and would sag under their own weight.



**ProTip:** Avoid track lengths that are nearly as long or as long as the spacing between tracks, as this can lead to severe maneuverability issues when turning (if it can turn at all).

# Section 1: Wheels

## Skills

-  Assemble a wheel and axle using hubs, bearings, and shaft stock.
-  Understand how omnidirectional wheels work.
-  Show how the force vector of Mecanum wheels help it to achieve omnidirectional movement.

## Review Questions

1. What makes Mecanum and omni wheels different from traction wheels?
2. What is the difference between a live axle and a dead axle?
3. Why are compliant wheels not well suited for drivetrains?

## Section 2

# Drivetrain

# Drivetrain Basics

A drivetrain (or drive base) is the basis of your robot, it's what moves it around the field. Reliability and consistency in this mechanism are the most important feature on your robot. Without a functional and effective drivetrain, your ability to positively contribute to every match is severely impacted. Teams should select which drivetrain to use in a given season based on attributes that matter to game strategy, maneuverability, grip, and driver experience. The two main groupings of FRC drivetrains covered in this section are **tank** and **holonomic drives**.

## Tank drivetrains include:

- Four Wheel Drive
- Six Wheel Drive
- Eight Wheel Tank

## Holonomic drivetrains include:

- Mecanum Drive
- Crab / Swerve Drive
- Omni ("X") Drive
- Kiwi Drive
- Slide Drive
- Octocanum / Butterfly Drive



# Drivetrains

## Major Drivetrain Types

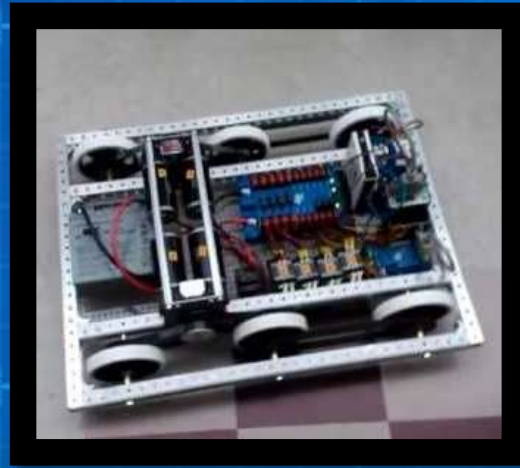

Tank

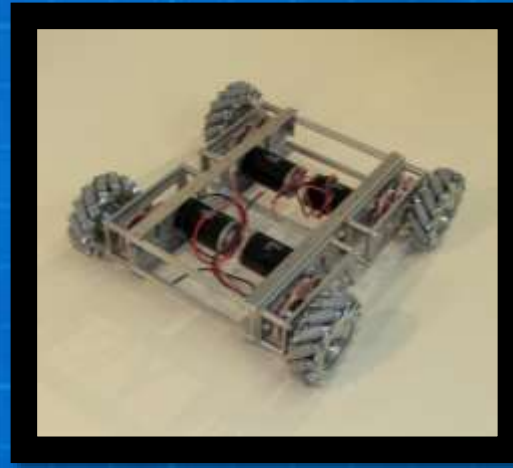

Holonomic



# Tank **Drives**

Drivetrains in which each side is independently powered. Also known as a Skid Steer.

# Drivetrains

## Four-Wheeled Tank

- Left and Right sides driven independently.
- Commonly uses 2 traction wheels and 2 omni wheels.
- Former KOP chassis style years ago, now uncommon in FRC.

### Pros:

Simple to design, build and program.

### Cons:

Large turning radius; Least traction of all tank drives.

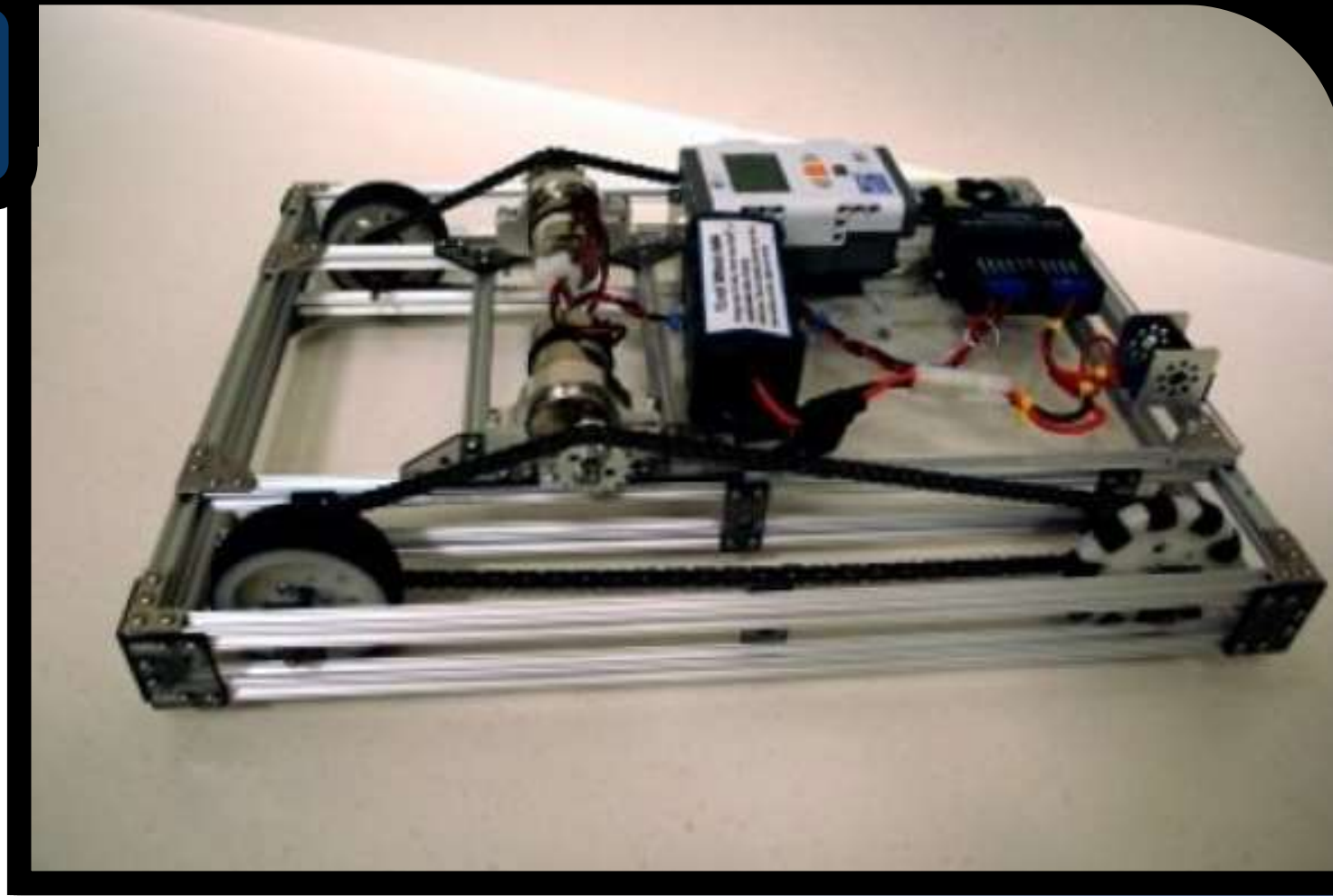

**Four-wheeled tanks may have all traction wheels, provided the following are true:**

- Wheelbase is less than the track width.
- Wheel coefficient of friction is the same when moving forward or sideways.



# Drivetrains

## Six-Wheeled Tank

- Left and Right sides driven independently.
- Dropped center wheels, or omni outer wheels.
- Left/Right sides driven independently.
- Most common type of FRC drivetrain.

### Pros:

Durable; Simple to design, build and program.  
Cheap; Ample support for the KOP chassis kit.

### Cons:

Standard means you'll be equally matched frequently (especially if using KOP chassis);  
Slight rocking due to dropped center wheels;  
Potential wheel scrub problems with long chassis configurations.

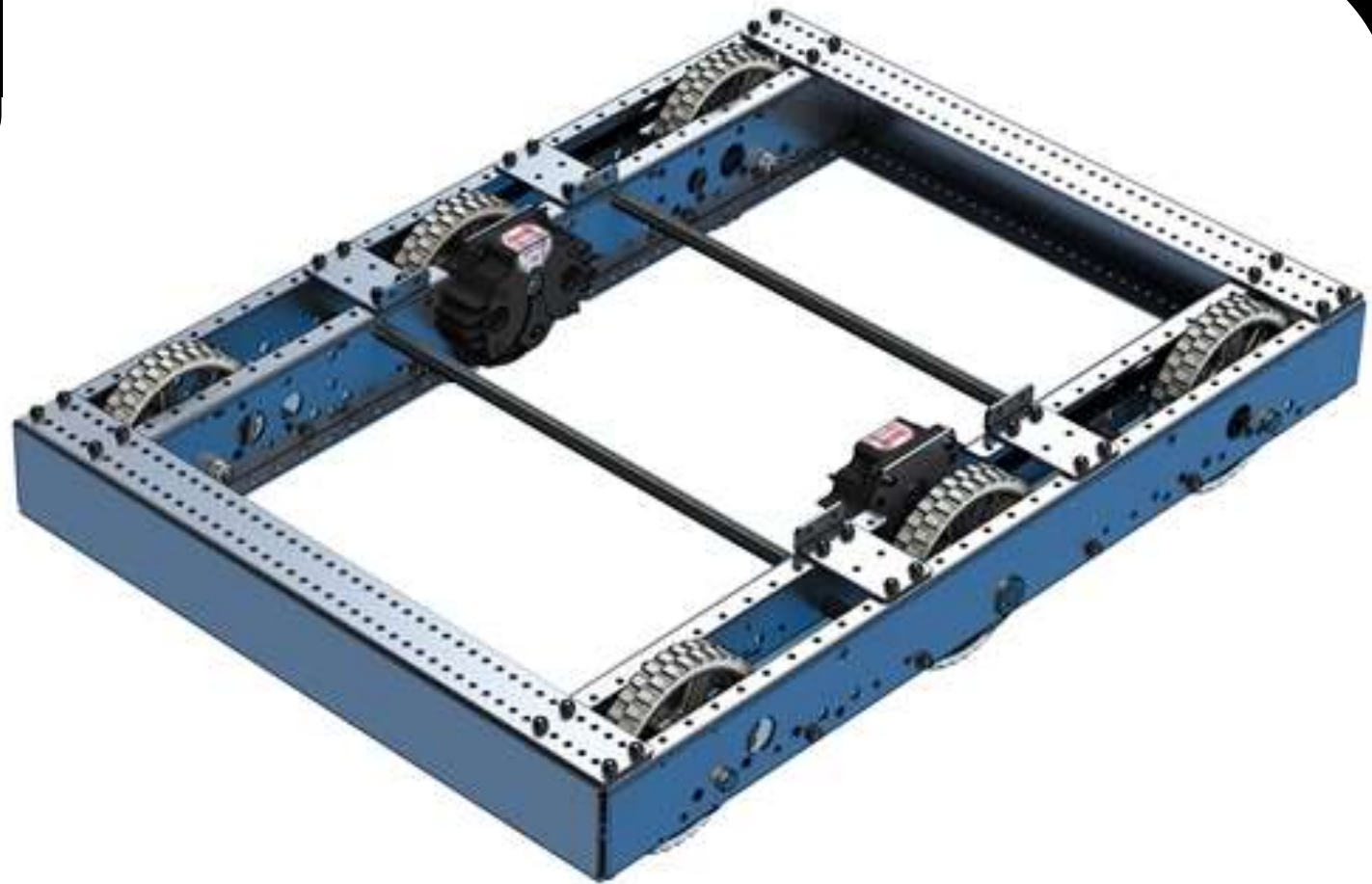

# Drivetrains

## Eight-Wheeled Tank

- Left and Right sides driven independently.
- Dropped center wheels (2 per side).
- Left/Right sides driven independently.

### Pros:

Durable; Relatively simple to build; More traction, Better at handling ramps and other irregularities than 6-wheel, less likely to high center

### Cons:

Custom build or serious modification required; Greater likelihood of wheel scrub problems with long chassis configurations. Mo' wheels, mo' problems.

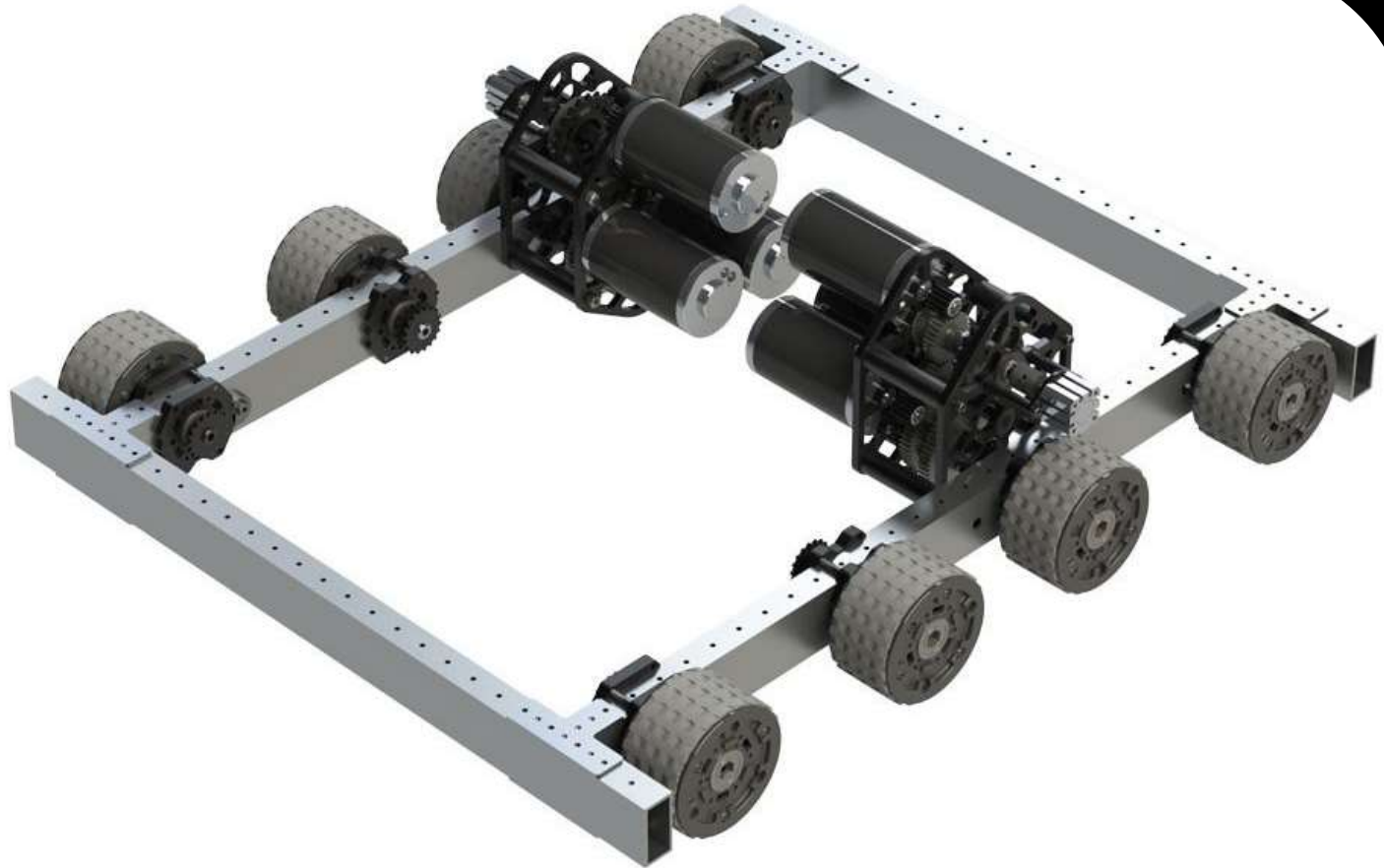

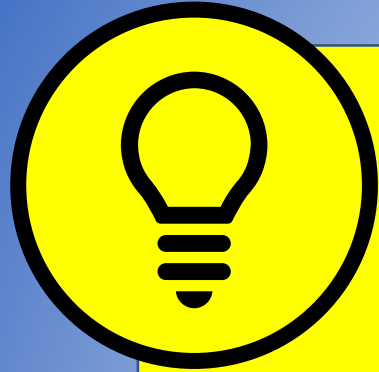

## No Scrubs: Dropped Center and Omni Wheels

Wheel scrubbing is unwanted friction condition caused by sideways movement of traction tires, such as in a spin or turn. It's like drifting, but it's not cool when robots do it. Scrubbing creates an additional load on drivetrains, causing them to draw more current. Spikes in current draw can trigger brownout protection, which results in a temporary loss of power to the drivetrain. Because of this, tank drives typically utilize one of the two strategies shown below.

### Example 1:

Tank drive shown with six traction wheels with the center slightly lower in relation to the front and back.

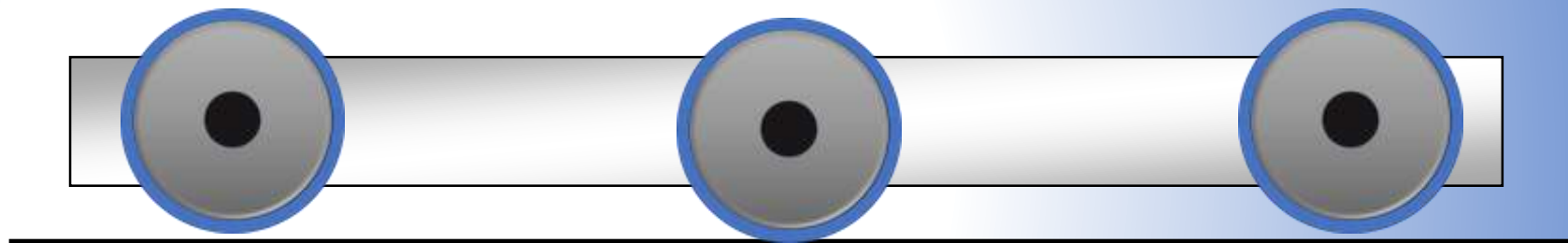

**Pros:** *More traction*

**Cons:** *Slight rocking; Wheel scrubbing*

### Example 2:

Tank drive with center traction wheel and outer omni wheels. All wheels are installed on the same plane.

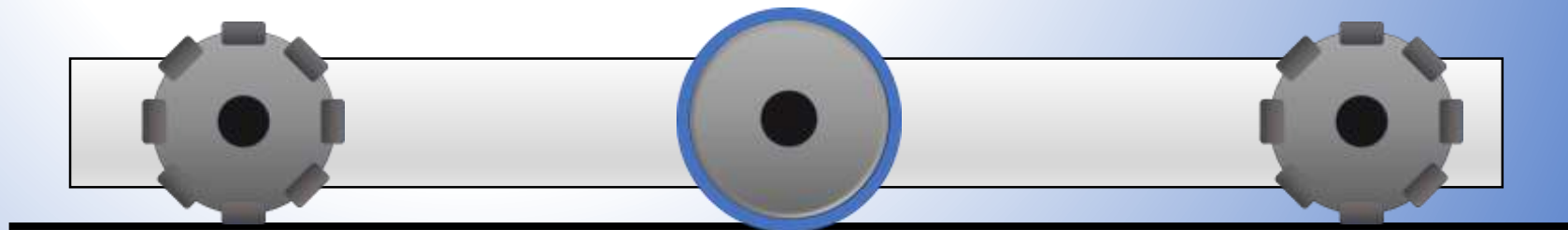

**Pros:** *Low center of gravity*

**Cons:** *Less traction*



## Coefficient of friction (CF):

The ratio between the force necessary to move one surface horizontally over another and the pressure between the two surfaces. The higher the number, the more friction is present. This is a relative value, a wheel may have a higher CF to the field carpet than to elements such as platforms, which are usually plastic.



## Option 3—Thinking Outside the Box

The whole point of using a dropped center or omni wheels is to reduce the coefficient of friction on the outer wheels relative to that of the center wheel. Simply put, the center wheels should have a higher CF than the outer wheels to prevent wheel scrubbing.

That said, it could possible to have a tank drive that is less reliant on omni wheels or dropped centers. Some teams have experimented with drivetrains that use different tread types. One common variation on this is use of Pebbletop tread for outer wheels, due to their reduced scrubbing. This illustrates that while there are always best practices for any design, there is not necessarily one right way to do things, so don't be afraid to try out new ideas!

Aggressive traction wheel= High CF

Smooth traction wheels= Lower CF

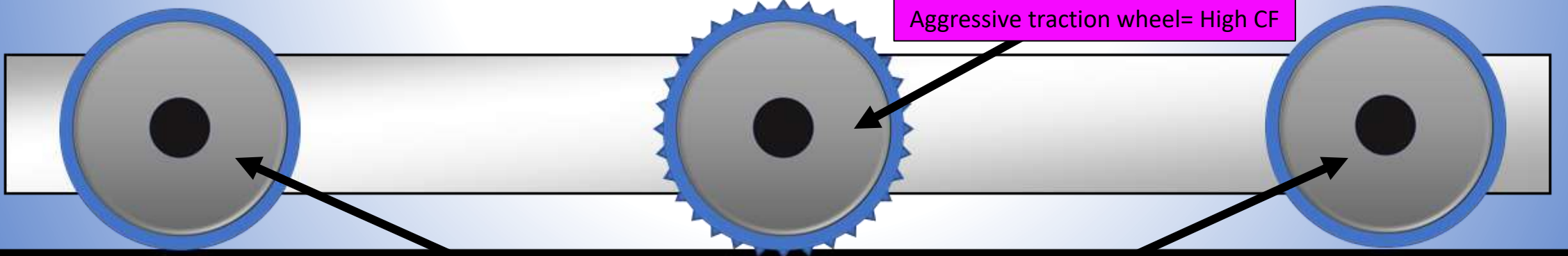



# Holonomic **Drives**

Where the controllable degree of freedom is equal to the total degrees of freedom of drivetrain movement.

# Drivetrains

## Mecanum

- Requires 4 independently driven wheels.
- Wheels must be installed correctly due to vectored rollers.
- Capable of full omnidirectional movement.

### Pros:

Fairly easy to design and build; Good programming support available; Agile.

### Cons:

No potential for pushing force. Challenging to learn to drive well. Added expense due to costly wheels and extra gearboxes.

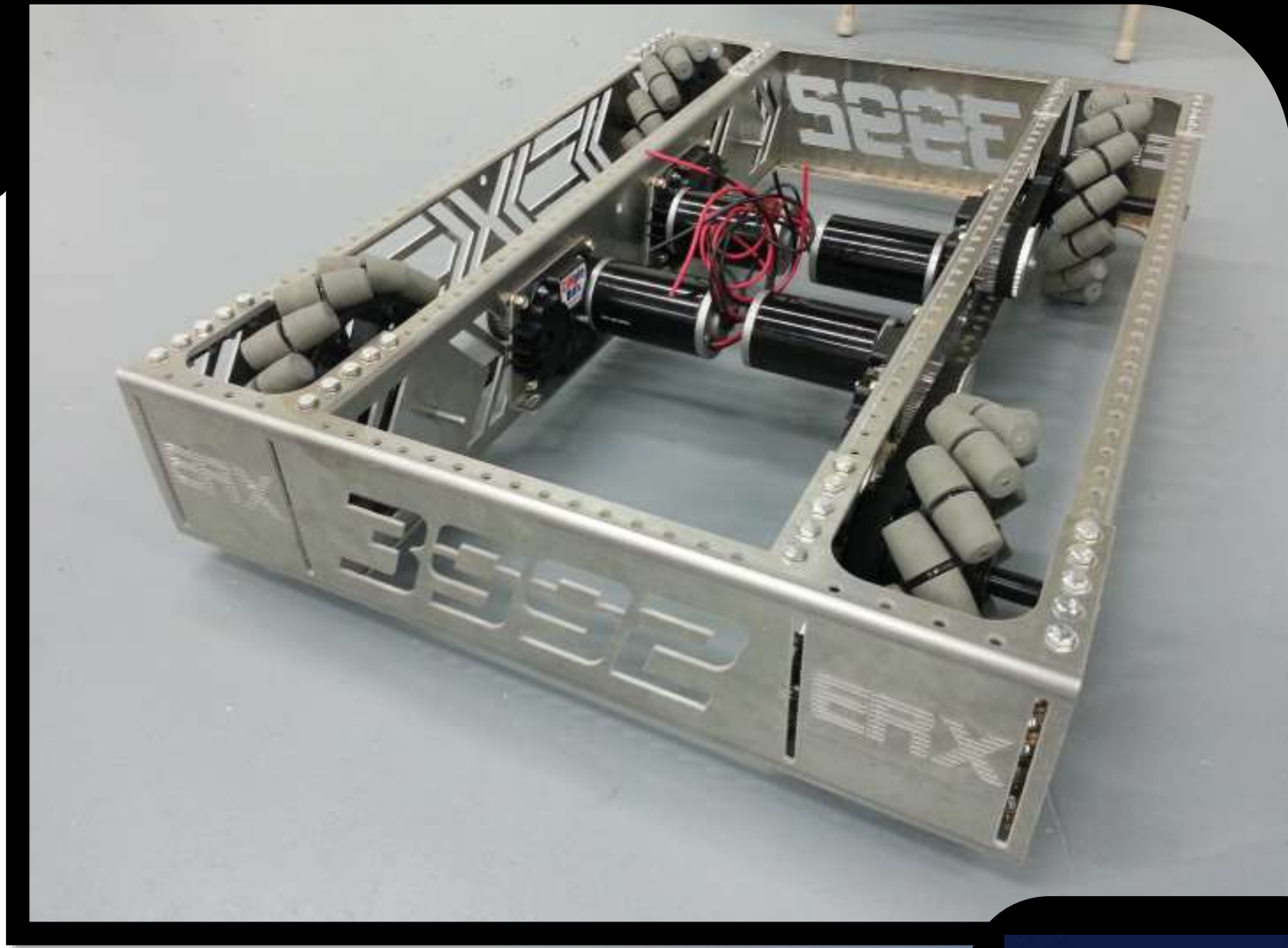

# Drivetrains

## Swerve/Crab

- Uses 4 independently powered traction wheel modules which rotate on a vertical axis to control direction.
- Capable of full omnidirectional movement with a great deal of agility and power.
- Crab steers pairs of wheels together; Swerve has more complex independent steering.

### Pros:

High speed and pushing force; Agile.

### Cons:

Most complex and expensive drivetrain to design and build, few COTS modules available.

Programming is exceedingly difficult. Requires at least 8 motors. More potential failure modes.

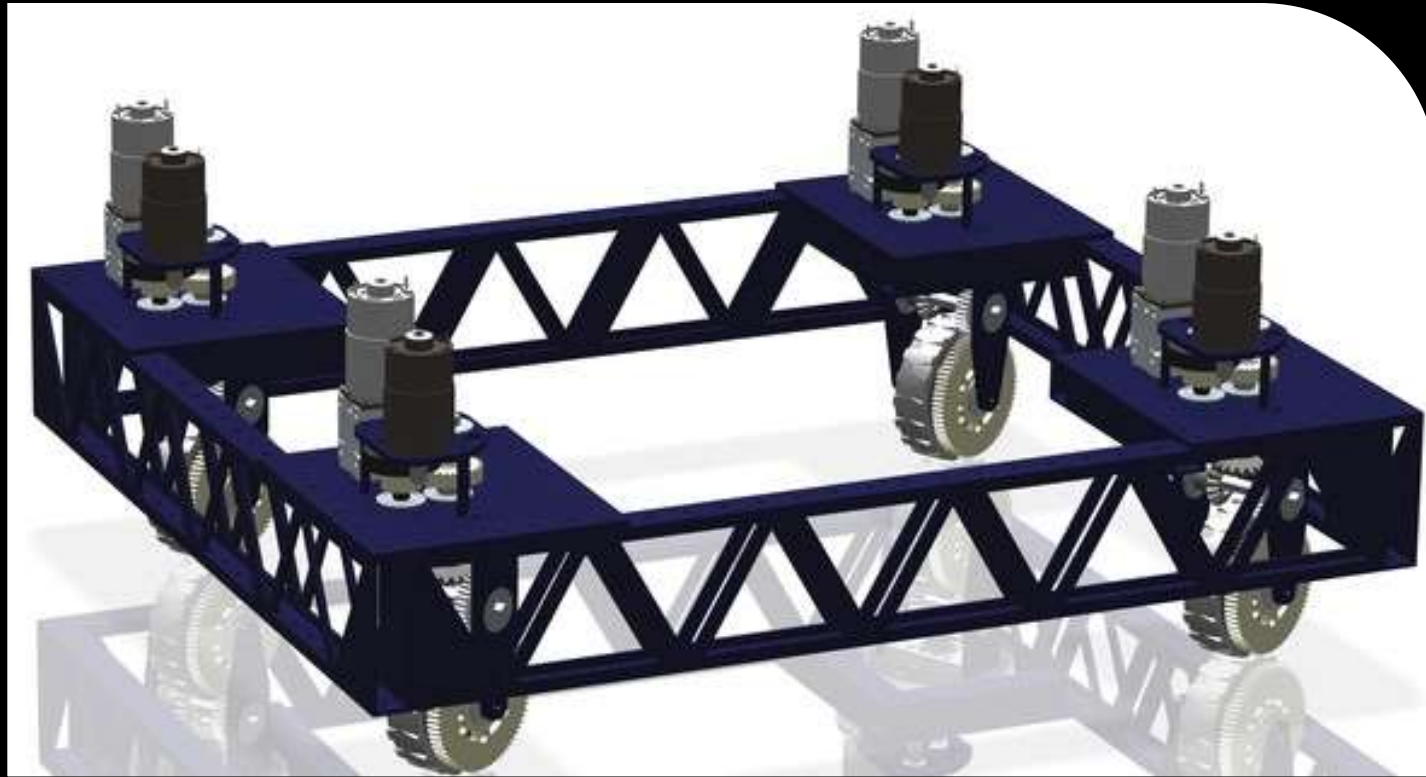

# Drivetrains

## X-Drive/Killough

- 4 omni wheels positioned on 45° angles in the corners of the frame (“X” pattern).
- Each wheel must be driven independently.
- Uses all omnidirectional wheels.

### Pros:

Agile; Good programming support.

### Cons:

No potential for high pushing force. Challenging to program and learn to drive well. Requires extra gearboxes.







## Look familiar?

Even though Mecanum wheels appear to be mounted in a traditional pattern at first glimpse, when their force vector is taken into consideration we realize that they behave very differently. Looking at the pattern of omni wheels on an Omni “X” Drive, do you see any similarities in how the two drivetrains might behave?

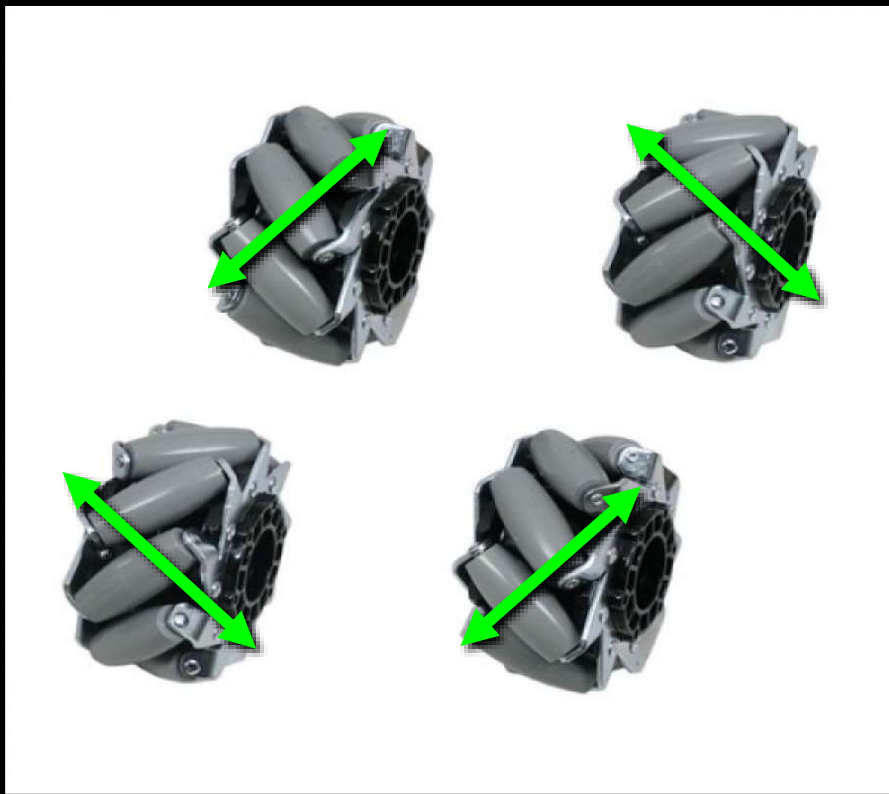

*Force vector of Mecanum wheels*

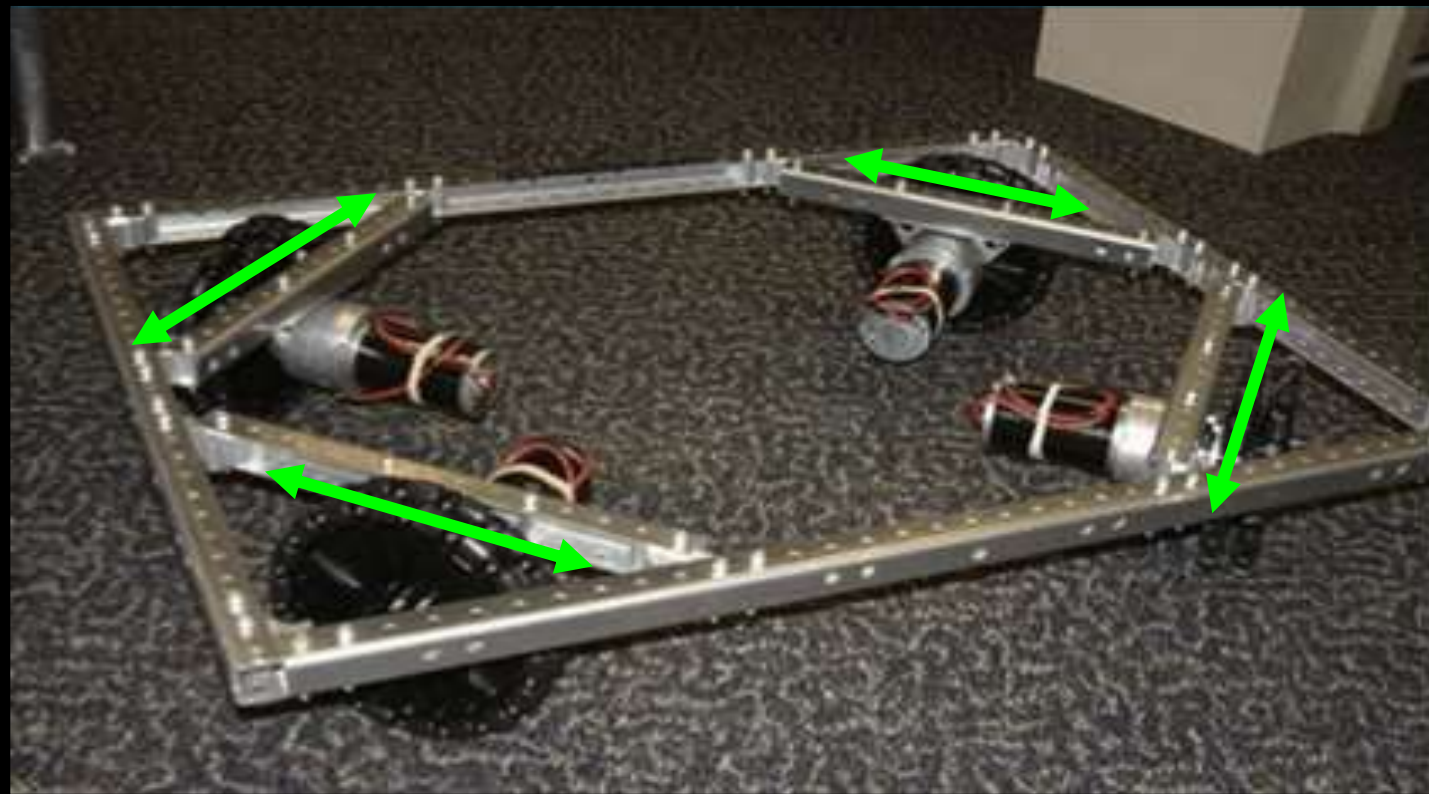

*Wheel pattern of omni wheel X drive behaves similarly to Mecanum drive*

# Drivetrains

## Kiwi

- 3 omni wheels positioned 120° apart at the corners of the frame.
- Frame is typically triangular.
- Each wheel must be driven independently.
- Uses all omnidirectional wheels.

### Pros:

Agile; All wheels on same plane; Remarkably insensitive to irregularities in the drive surface, compared to Mecanum or Killough/X drive.

### Cons:

No potential for high pushing force; Difficult to code.



# Drivetrains

## Slide

- Similar layout to tank drive, with an extra wheel(s) perpendicular to the rest.
- Uses all omnidirectional wheels.

### Pros:

Fairly easy to design and build. Agile.

### Cons:

No potential for high pushing force. Extra wheels, motors, and gearbox required to allow robot translate sideways. Middle wheel tends to get caught going over small obstacles or uneven surfaces if not actuated to get out of the way.

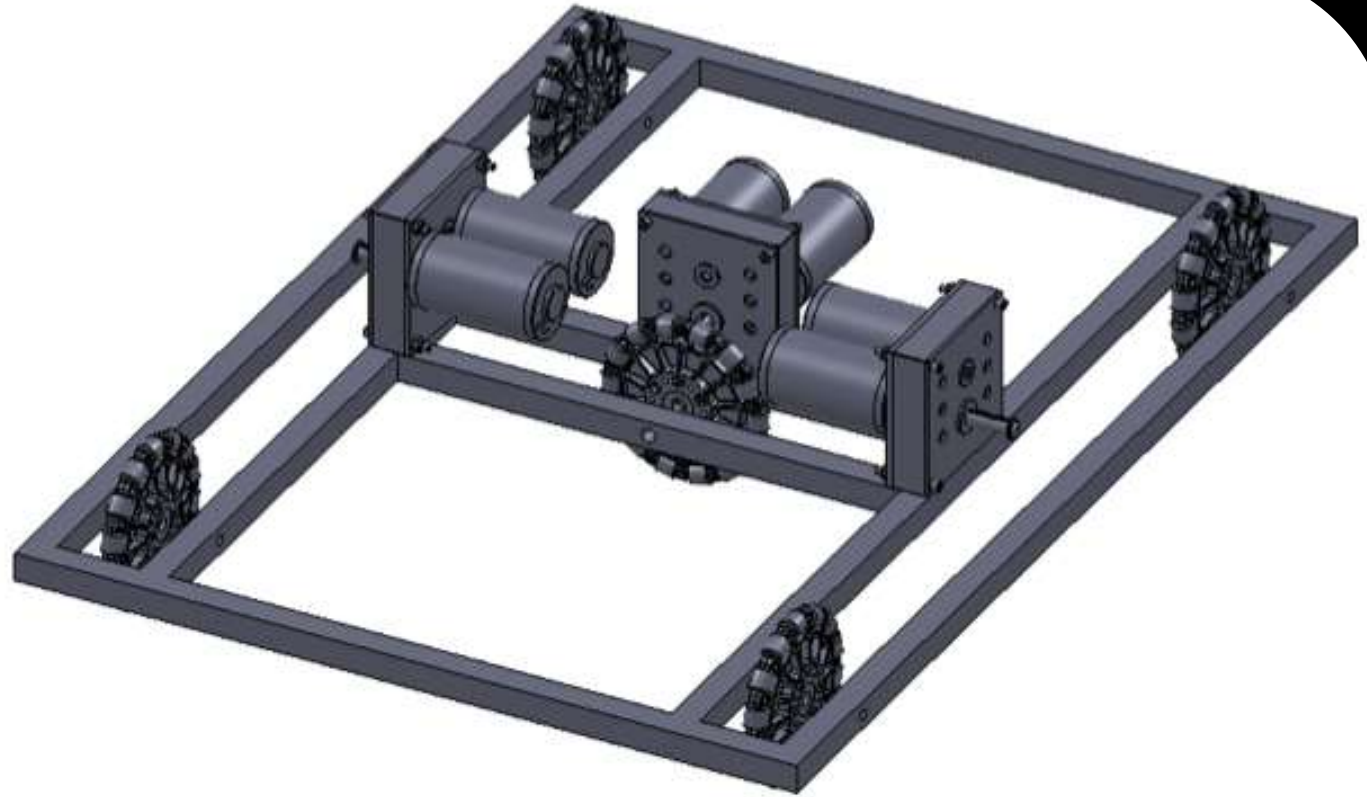

# Drivetrains

## Octocanum/Butterfly

- 4-6 wheeled traction wheel tank drive, with actuated “drop down” Mecanum drive wheels.
- Maneuverability of a Mecanum drive with the speed and pushing force of a tank drive,

### Pros:

Potential for high speed and/or pushing force.  
Agile.

### Cons:

Very complex and expensive to design, build and program. Pneumatic system needed for drop down drive. Requires extra gearboxes. Wheels are expensive.

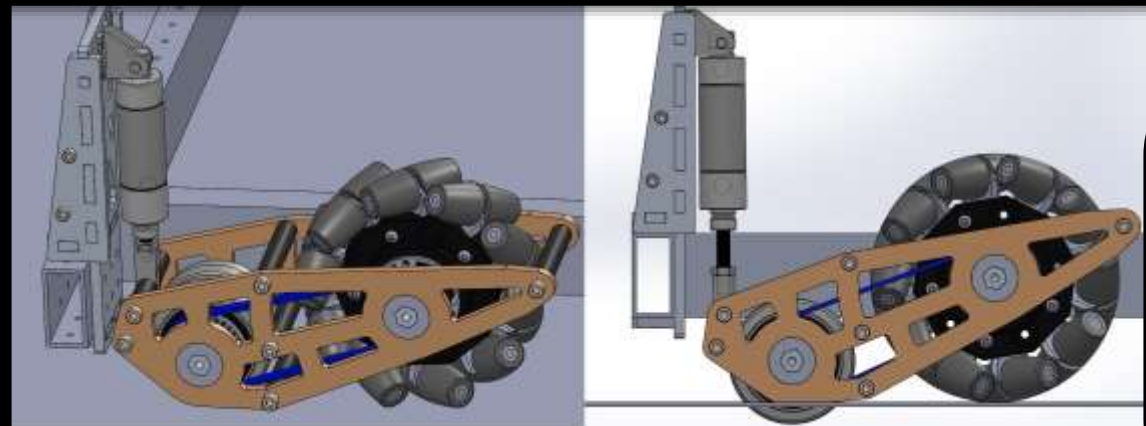
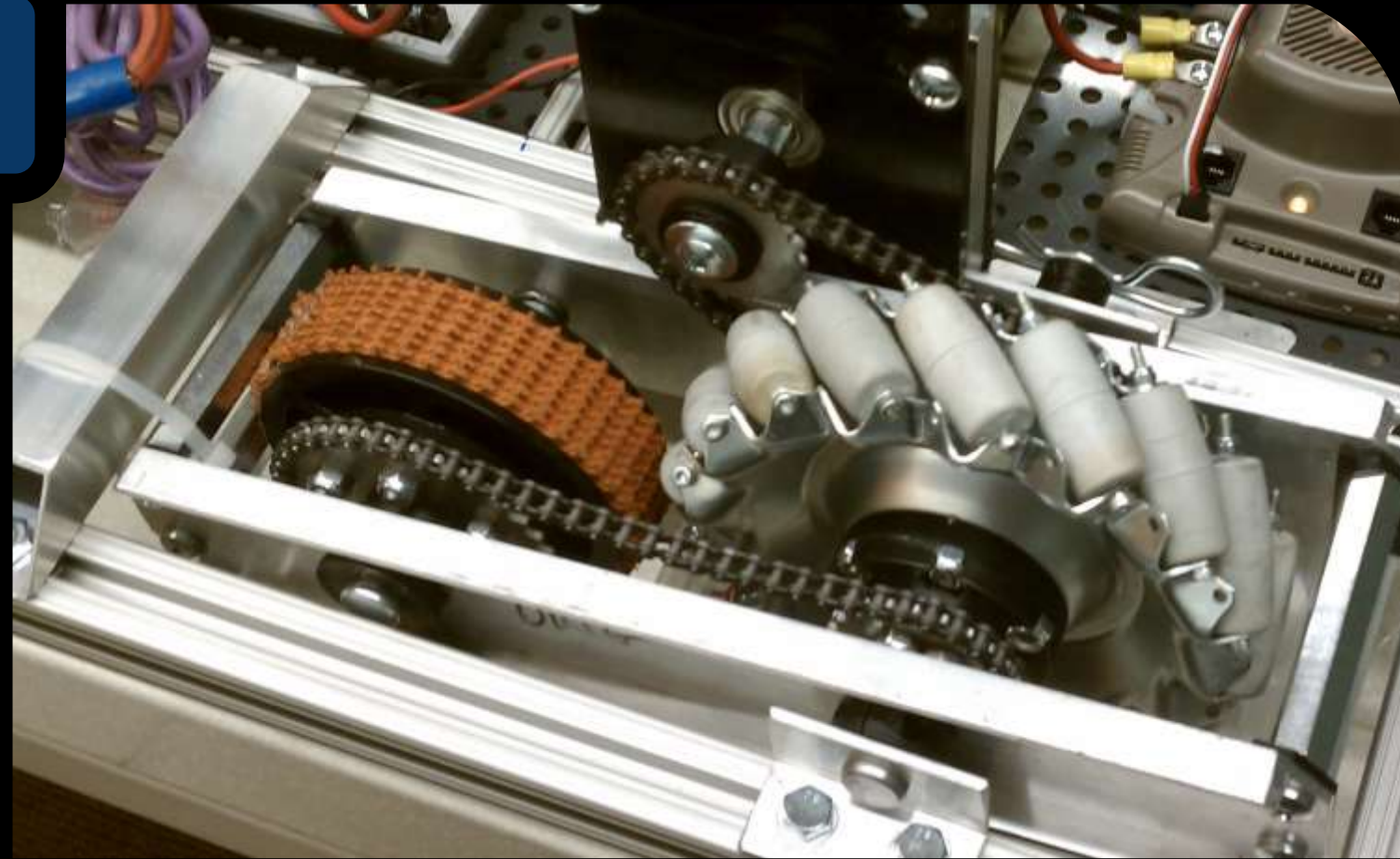



## Choosing the Right Drivetrain

For the most part, the standard AndyMark Kit of Parts (KOP) chassis is more than sufficient to complete game objectives. It is easy to assemble, sturdy, and is an overall, tried-and-true performer.

Despite this, a number of teams opt for alternatives. While the reasons vary and may be driven by cost reduction, game strategy, or just the desire to tackle a greater challenge, all teams should make this decision carefully and be sure to weigh all the pros and cons of each option. ***Whichever option you choose, it's important to ensure your team is up to the task and is not building beyond their means in terms of cost, materials, technical proficiency, and time available***

Drivetrain	Complexity	Maneuverability	Pushing Power	Learning Curve
Tank (Skid Steer)	Decreased	Decreased	Increased	Decreased
Holonomic (Omni/Mancanum)	Increased	Increased	Decreased	Increased
Holonomic (Swerve/Crab)	Increased	Increased	Increased	Increased

# Section 2: Drivetrains

## Skills



Be able to identify at least 5 major drivetrain styles.



Accurately predict drivetrain movement capabilities when pit scouting.



Understand the strengths and weaknesses of different categories and styles of drivetrains.

## Review Questions

1. How can wheel scrubbing be mitigated in a tank drive?
2. What is the disadvantage of a 4-wheel tank drive?
3. What drive types are most vulnerable to defense and why?
4. How is an X-Drive similar to a Mecanum drive?

## **Section 3**

# **Chassis Fabrication**

# Chassis

## Common Fabrication Methods



Sheet  
Metal



Aluminum  
Tubing



T-Slotted  
Extrusion



Perforated  
C-Channel



# Chassis

## Sheet Metal Kit

(AndyMark AM14U3 KOP Chassis; Vex Drive in a Day Chassis Kit)

Standard kit of parts (KOP) chassis given out at Kickoff. Good enough for most tasks.

### Pros:

Quick, reliable build; Easy belt and wheel spacing;  
Robust construction; Comes with KOP. Help available.

### Cons:

Limited configuration and adjustability possibilities (without custom machining); Can be hard to work on in pits.

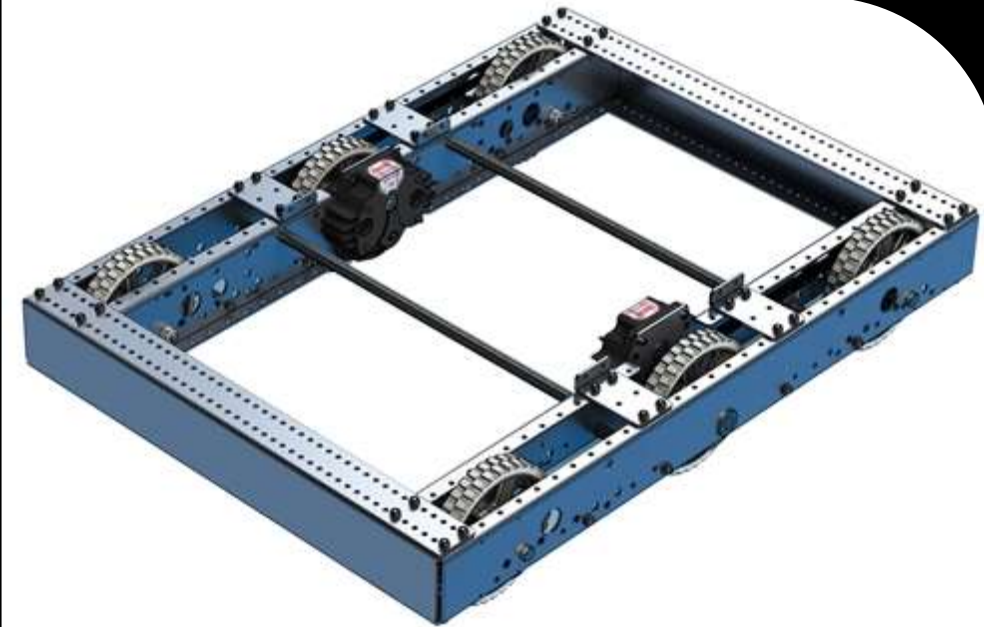

2018 AndyMark KOP Chassis



Vex 2014 Drive in a Day Chassis Kit

# Chassis

## Custom Sheet Metal (Custom Design and Fabrication)

### Pros:

Total control of size, weight, materials, and fabrication. Can pocket heavy stock to reduce weight. Spare parts.

### Cons:

Requires extensive knowledge, support and manufacturing resources, such as CAD, water-jetting or laser cutting, and accurate bends. New designs may be unreliable.



# Chassis

## Aluminum Tubing (Vex VersaChassis)

Simplified fabrication using 1x2 aluminum tube stock.

### Pros:

Tube stock readily available; Adjustable chain/belt tension; Easy access for pit repairs. Pre-drilled holes if using VersaChassis.

### Cons:

Problems if not designed/built correctly; Bearing blocks and gearboxes can come loose over time.

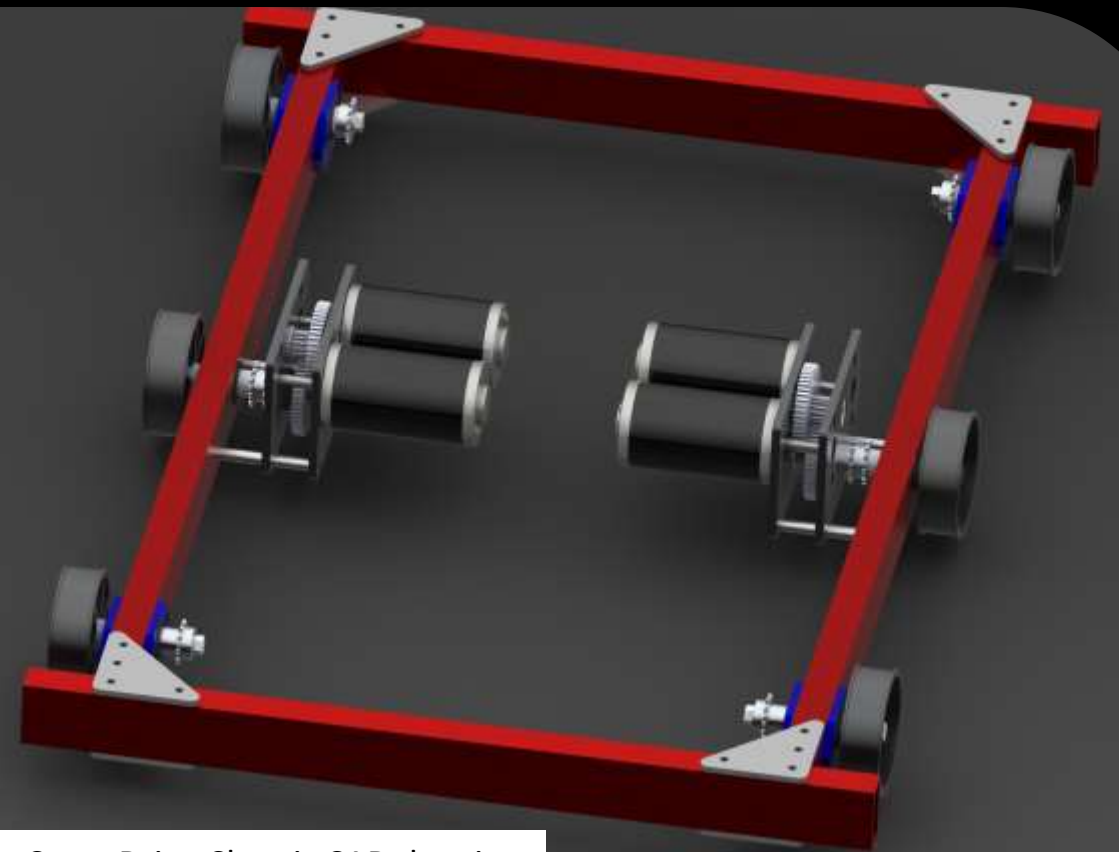

West Coast Drive Chassis CAD drawing



1"x2"x0.125" Tube

# Chassis

## T-Slotted Extrusion

(REV Extrusion, 80/20, Bosch Rexroth)

Slotted extrusion available in various sizes and cross-sectional profiles. "Erector set for adults."

### Pros:

Robust material designed for bolt-together construction; Works well when translating linear motion.

### Cons:

Heavy; Fasteners can work loose or break free of channels; Expensive; Can be difficult to machine.

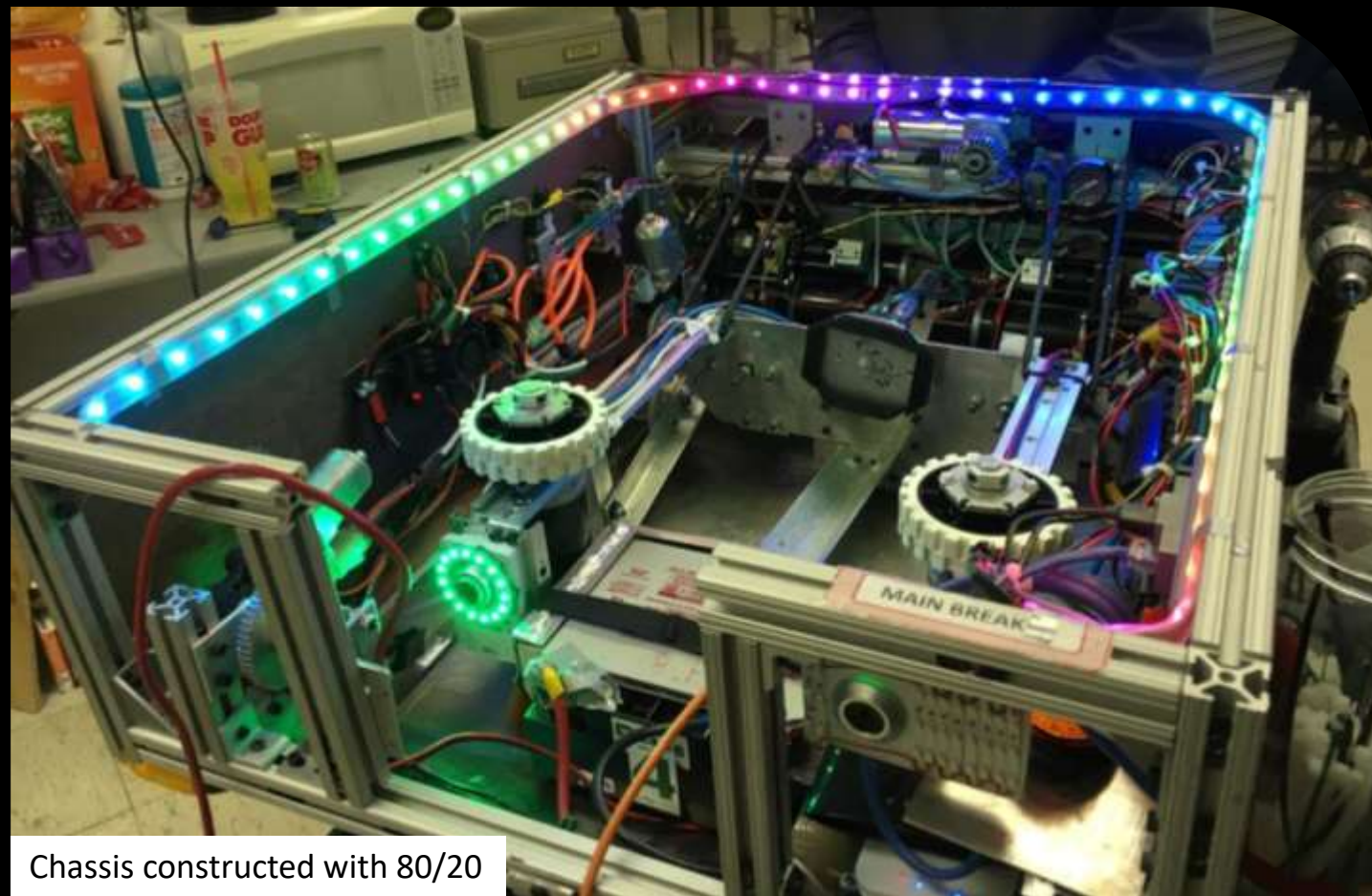

Chassis constructed with 80/20



Various sizes and profiles of T-Slot Extrusions

# Chassis

## Perforated C-Channel (AM C-Base)

Used in KOP Chassis until 2013.

### Pros:

Erector set-type assembly for quick and dirty builds and prototyping.

### Cons:

Mostly obsolete; Rickety and ugly by today's standards.



2013 AndyMark C-Base KOP Chassis



Perforated C-Channel



# Fabrication Techniques

Here are a few of the most common methods of fabricating chassis frames found in FRC.

## Nuts and Bolts

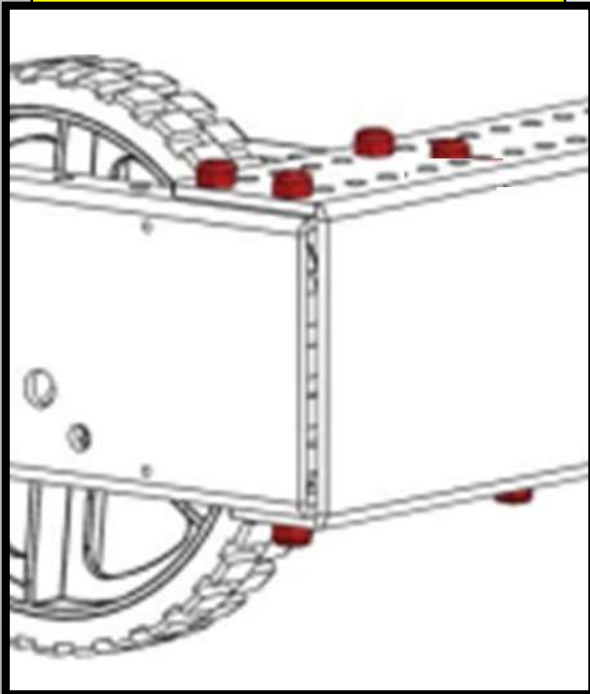

Bolt together construction using hex head fasteners and nylock nuts is a common to sheet metal builds

## Riveted Gussets

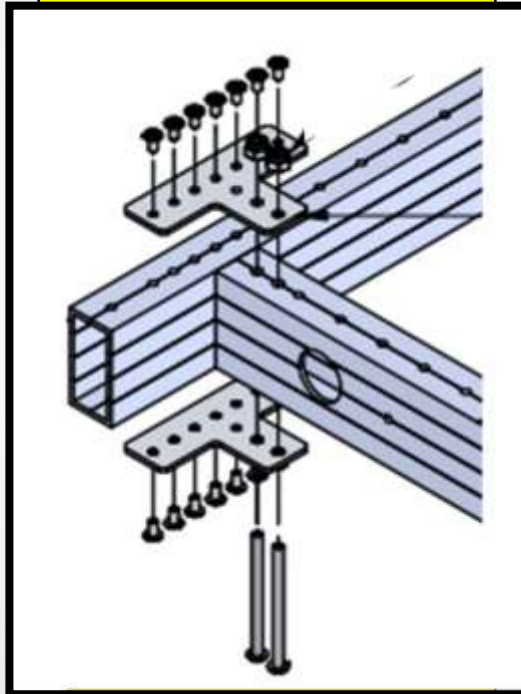

Most tube stock construction uses steel rivets and T-braces as well as bolts.

## T-Locks



Specially designed fasteners for aluminum extrusion that drop into channels and tighten with bolts.

## Welding



Clean/durable joints when done correctly. Requires special equipment. Typically not repairable at competition.

# Section 3: Fabrication

## Skills



Explain the difference between a KOP chassis and a custom sheet metal build.



Identify common chassis build materials, including: sheet metal, T-slotted extrusion and tube stock.

## Review Questions

1. What is the most common chassis fabrication type?
2. What are some resources needed for a custom sheet metal chassis build?
3. Why is T-slotted aluminum extrusion not commonly used for whole chassis construction?

## **Section 4**

# **Materials**





# **Metals**

Elemental, compound, and alloy materials  
useful for having a solid state that is both  
malleable and fusible

# Aluminum

**Learn it. Live it. Love it.**

For chassis and structural fabrication we use aluminum due to its relatively high strength and low weight.

However, not all aluminum alloys are equal and each has its own strengths and weaknesses when it comes to different applications.

The following is a good general rule of thumb for using aluminum in FRC:

- **Sheet metal/Bending** → 5052 Alloy
- **Common Flat/Angle Stock** → 6061 Alloy
- **Plates/Gussets/Extrusions** → 6063 Alloy
- **Shafts (Hex or Round)** → 7075 Alloy

**ProTip:** Be careful if placing high loads on 7075 parts. Some call the alloy aluminum trying to be steel. It is very strong, but at the end of the day it is still just aluminum.

6061-T6/T651



Most Common series.  
Strength greatly dependent on annealing; reduced by bending and welding.

Vex VersaChassis

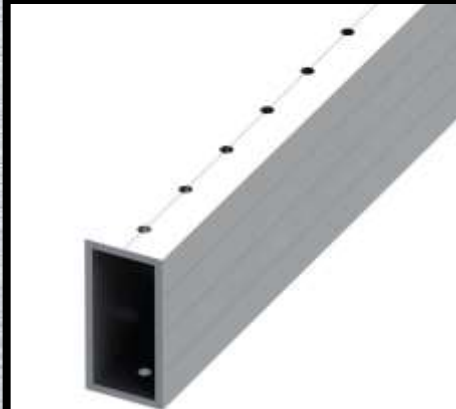

5052-H32



Capable of being welded or bent without losing much strength. Reduced Corrosion resistance.

AM KOP Chassis



7075-T651



One of the highest strength alloys available, making it ideal for shaft stock and gears.

AM/Vex Hex Shafts



## Aluminum Alloy Chart—There will be a test on this! (Ok, no, not really, but it shows the differences between various alloys)

Type	Workability	Weldability	Machining	Strength	Typical Applications
Alloy 1100	Excellent	Excellent	Good	Low	Metal Spinning
Alloy 2011	Good	Poor	Excellent	High	General Machining
Alloy 2024	Good	Poor	Fair	High	Aerospace
Alloy 3003	Excellent	Excellent	Good	Medium	Chemical Equipment
<b>Alloy 5052</b>	<b>Good</b>	<b>Good</b>	<b>Fair</b>	<b>Medium</b>	<b>Sheet Metal Bending</b>
<b>Alloy 6061</b>	<b>Good</b>	<b>Good</b>	<b>Good</b>	<b>Medium</b>	<b>Plates &amp; Sprockets</b>
<b>Alloy 6063</b>	<b>Good</b>	<b>Good</b>	<b>Fair</b>	<b>Medium</b>	<b>50% strength of 6061</b>
<b>Alloy 7075</b>	<b>Poor</b>	<b>Poor</b>	<b>Fair</b>	<b>High</b>	<b>Machining; High-Strength</b>

# Steel

## Remember: This isn't BattleBots.

Reaching 150lbs may seem a long ways away during the early stages of design and build, but weight piles on quickly. Steel offers superior strength when compared to aluminum, but is considerably more heavy, which is why it should be used sparingly.

Most teams use steel only when strength is crucial, such as the following examples:

- **High load bearing gears**
- **Gearbox shafts**
- **Most hardware (especially nuts, bolts, rivets, and some washers)**

***ProTip:** If you're not sure if a fastener is aluminum or steel, use a magnet. Aluminum is a non-ferrous metal, which means it does not contain iron and is not magnetic, like steel.*



# Aluminum

For chassis and structural fabrication

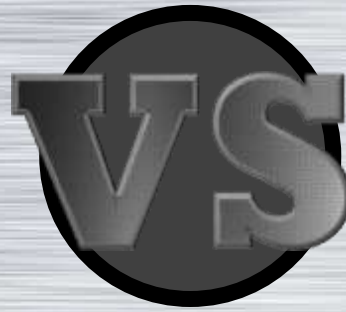

# Steel

Fasteners and crucial components

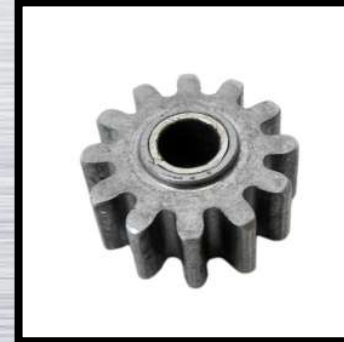

***Just like using the right tool for the job, learning where and when to use the appropriate materials is important for a successful robot build.***



# **Plastics**

Synthetic or semi-synthetic organic compounds that are malleable, moldable, and often machinable

# ABS

A low cost engineering plastic that is easy to machine and fabricate. ABS is an ideal material for structural applications when impact resistance, strength, and stiffness are required. It is widely used for machining pre-production prototypes since it has excellent dimensional stability and is easy to paint and glue.

## **Common Uses:**

**Sheathing; Thermoforming; 3D Printing**

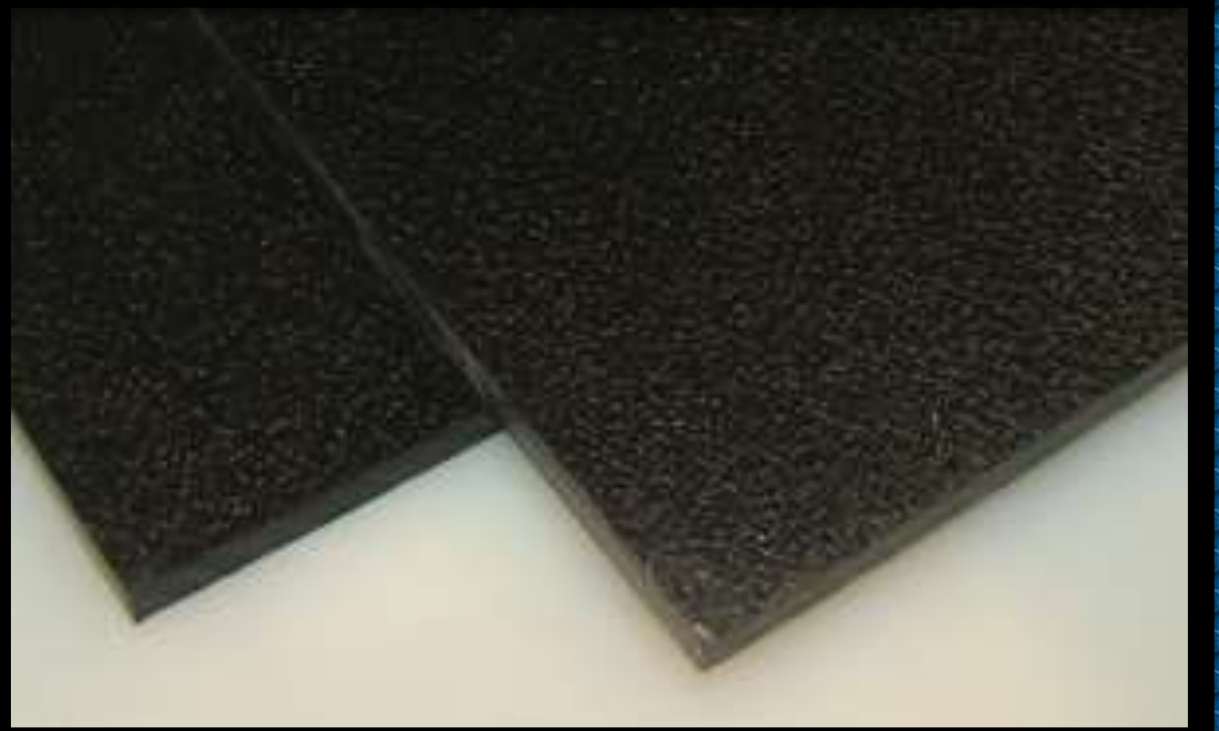

# Acetyl

Provides high strength and stiffness coupled with enhanced dimensional stability and ease of machining. Acetyl is also characterized by a low coefficient of friction and good wear properties, which is why it is commonly used for spacers in gearboxes and wheel assemblies.



**Common Uses:**  
Spacers and bushings where low-friction is required. Machined parts.





# Polycarbonate

A tough, strong polymer material easily worked, molded, and thermoformed. Most grades used in robotics are transparent and are available with perforations that are ideal for installing control system components.

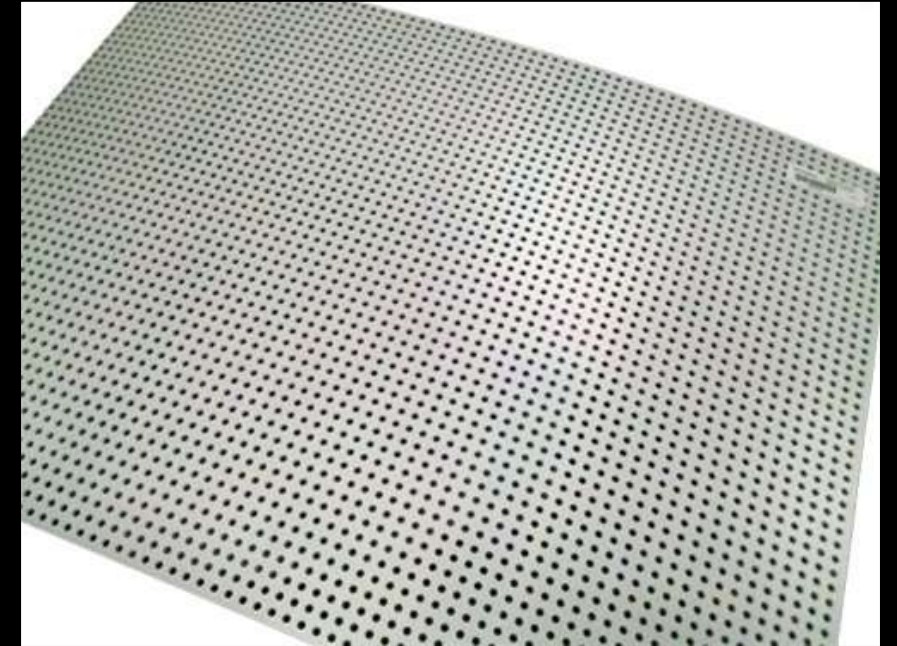

**Common Uses:**  
**Transparent, high impact sheathing;**  
**Sometimes used as a lightweight substitute for sheet metal.**

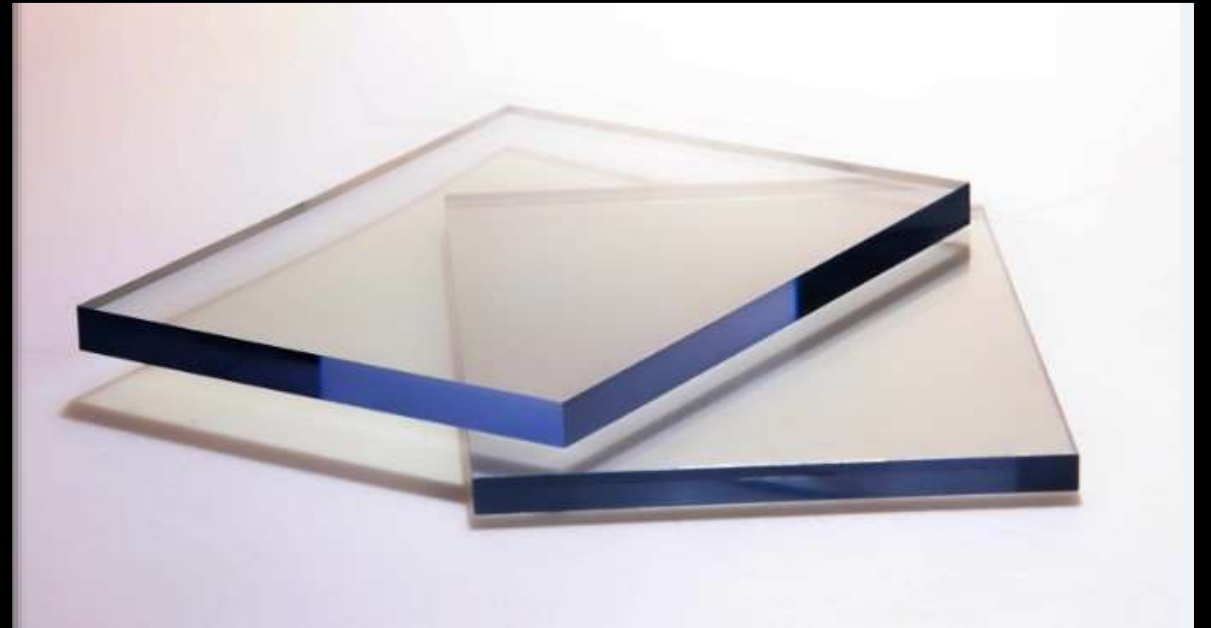
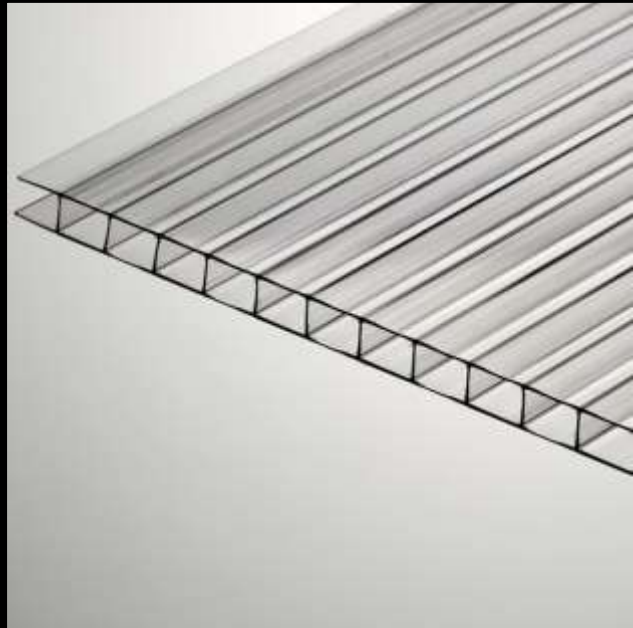

# UHMW

Ultra-high-molecular-weight polyethylene has the highest impact strength of any thermoplastic presently made. It's ideal for machining, has a low coefficient of friction and can be woven into strong fibers, such as Dyneema, which is frequently used in elevator mechanisms.



**Common Uses:**  
**Machined parts;**  
**High-tensile**  
**strength cord**  
**(Dyneema).**



# PLA

Poly(lactic acid) is a biodegradable and bioactive thermoplastic derived from renewable resources. PLA is widely used in 3D printing due to its low-cost, ease of use, and relatively low level of volatile organic compounds (VOC) emitted during extrusion.

**Common Uses:**  
**3D Printing filament**

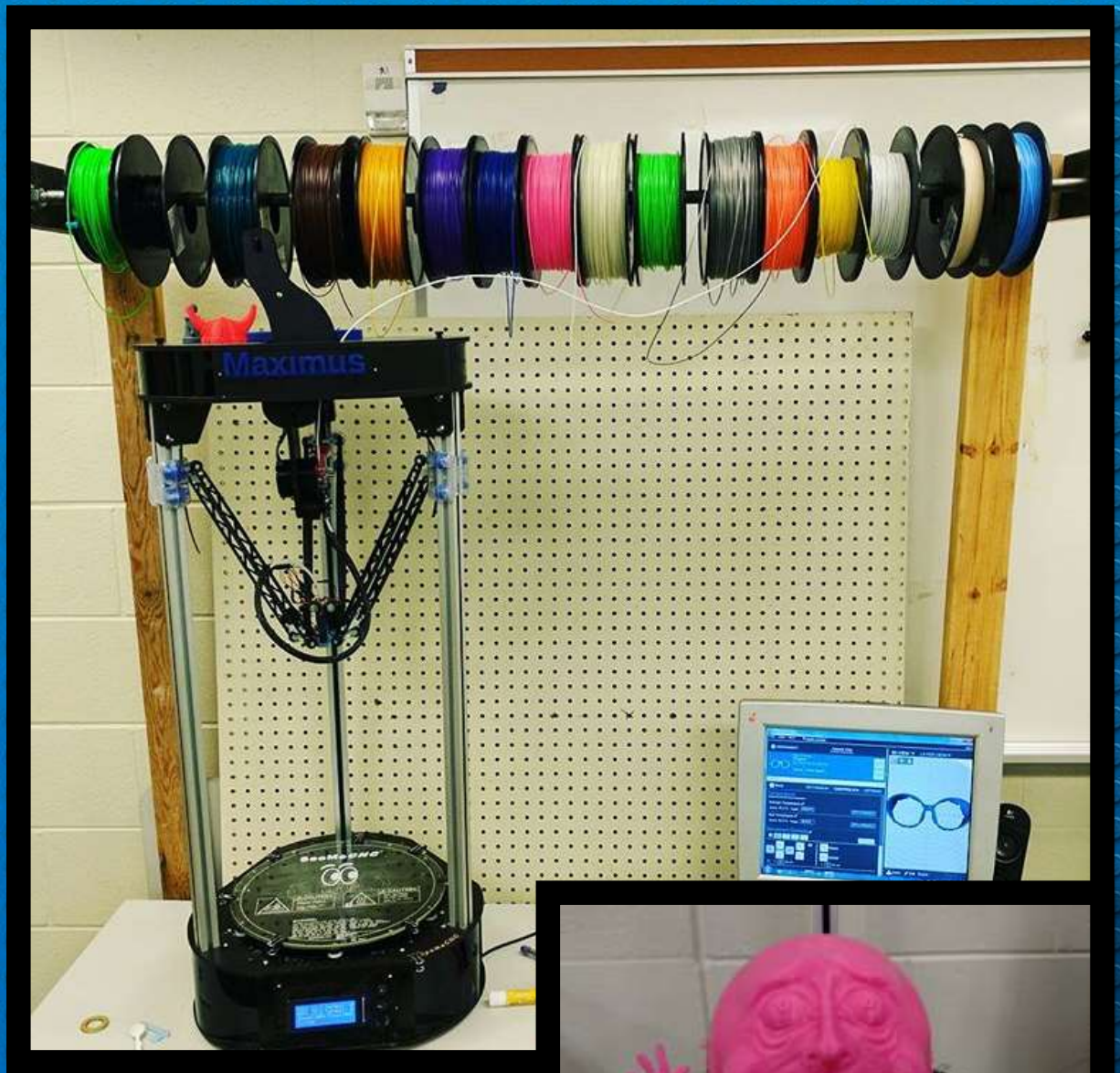

# Section 4: Materials

## Skills



Know when and where to use steel and aluminum to take advantage of their respective strength and weight advantages.



Become familiar with commonly used plastics and their basic properties.



Have some idea of the differences between commonly used aluminum alloys.

## Review Questions

1. What metal is used for chassis and structural fabrication and why?
2. What metal is used for fasteners, gussets and crucial components?
3. Which impact-resistant, transparent polymer is commonly used in FRC for side panels and mounting control components?

## Section 5

# Mechanisms

# Mechanisms

## Major Mechanism Types



Arms



Elevators and Lifts



Hybrids



# Arms

# Mechanisms

## Arms

Arms consist of a **pivot point**, a **bar** and an **actuator**. Being powered traditionally by either a motor set or a set of pneumatics, they allow rotation about a given point for the end of an arm. Typically the torque needed is large, and as such, teams need powerful motors and/or pneumatics to move them effectively.

*Both arms and linkages will likely need software and/or hardware stops to prevent breaking themselves in the event they overtravel.*

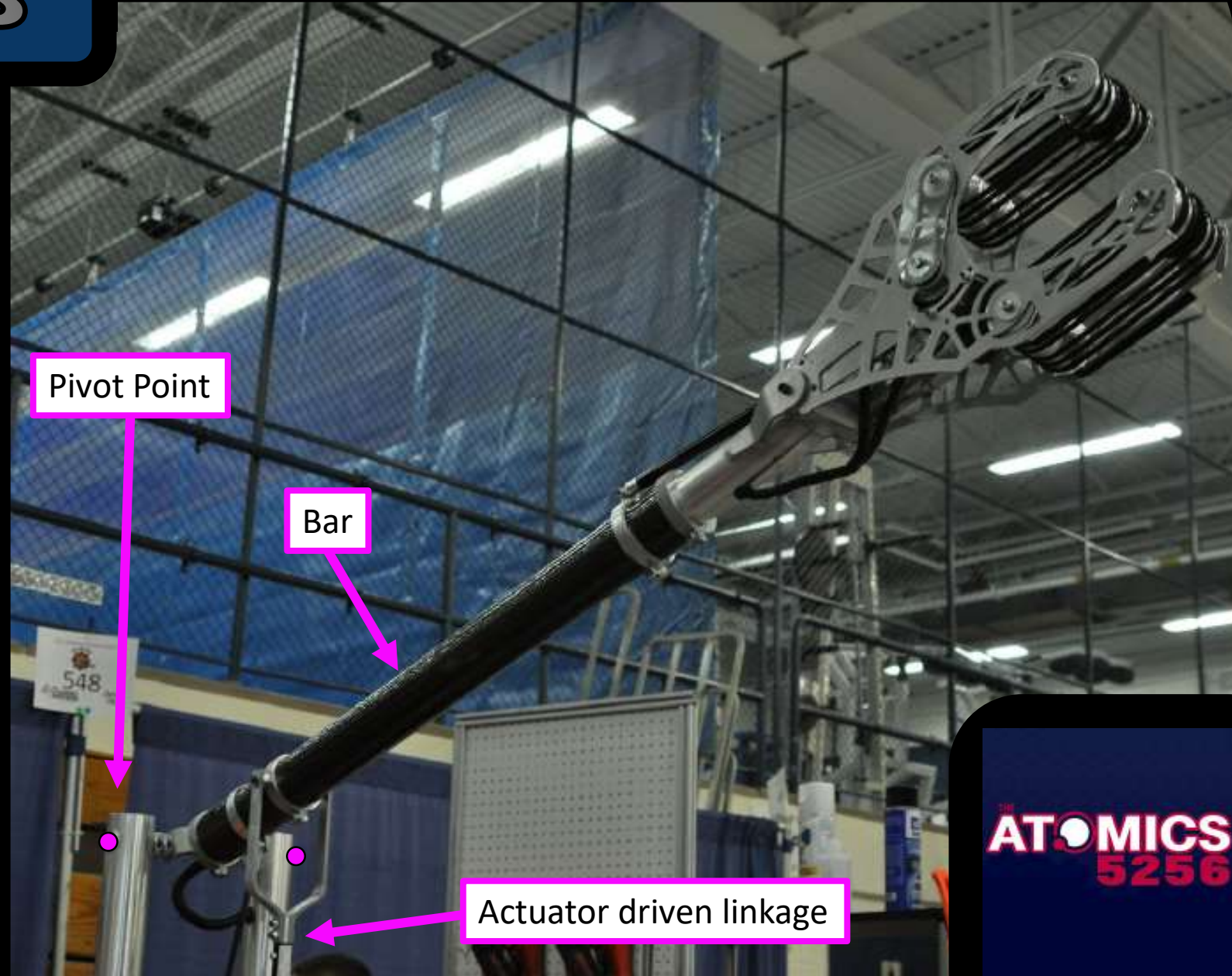



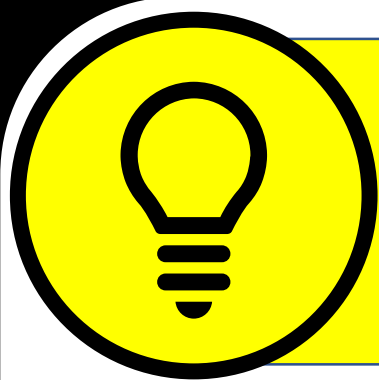

## Arm Forces, Angles & Torque

- Torque = Force x Distance
- Same force at different angle will need more or less torque.

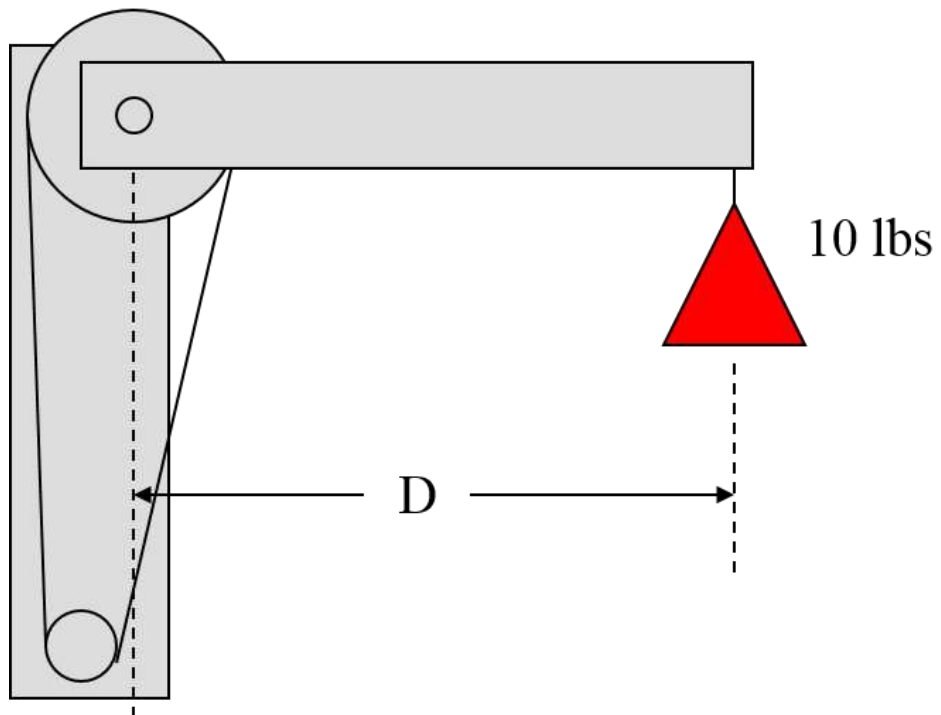

More Distance Requires More Torque

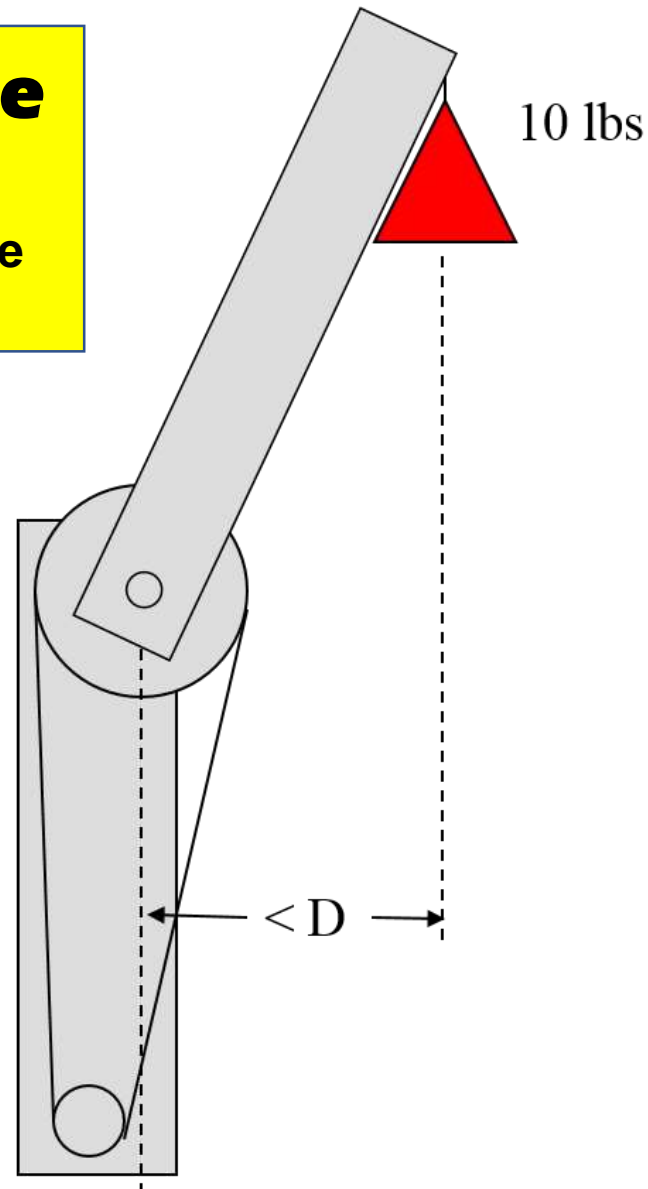

Less Distance Requires Less Torque



## Real World Example: Arm Forces, Angles & Torque

- Same force at different angle will need more or less torque.
- Weight held at arm's length will require more effort due to greater distance.



More Distance Requires More Torque



Less Distance Requires Less Torque

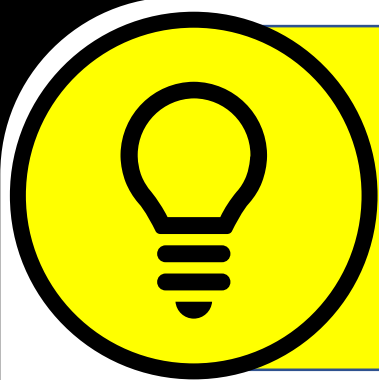

## Arm Power Example

- Same torque with twice the power results in twice the speed when under load
- $\text{Power} = \text{Torque} / \text{Time}$
- Be conservative: design in a safety factor of 2x or 4x

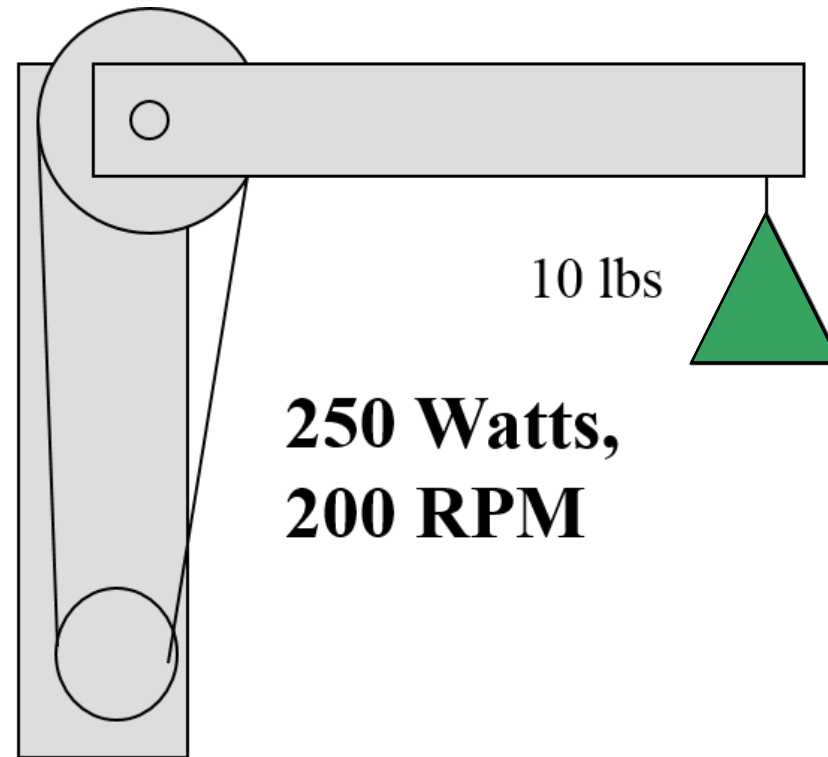
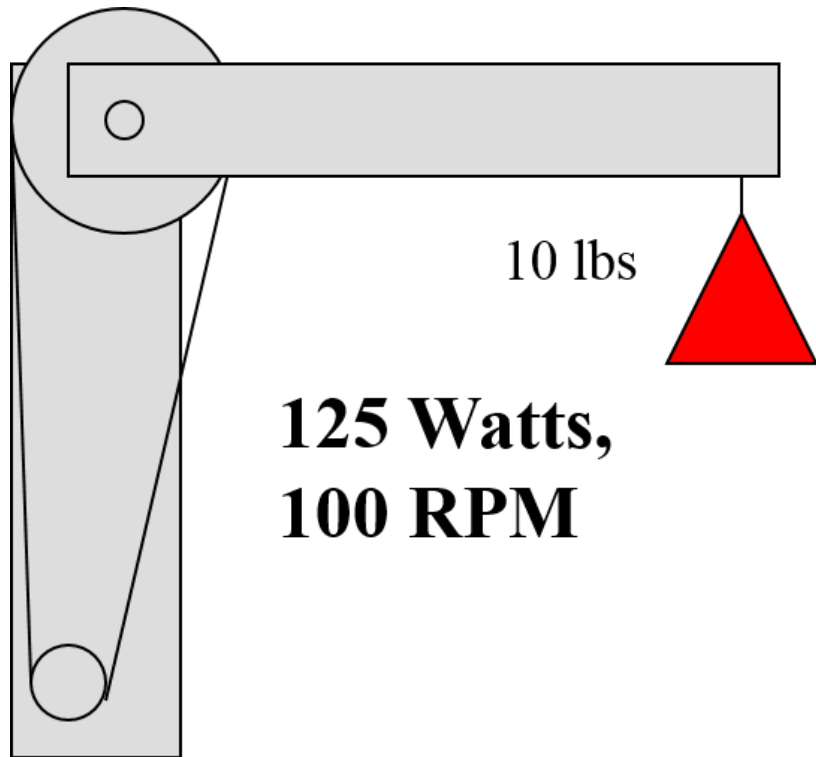



## Arm Power Real World Example

- Same torque with twice the power results in twice the speed when under load
- Stronger is often faster when it comes to handling demanding tasks.





## Work Envelopes

A robot's work envelope is its range of movement. It is the shape created by mapping its max in all possible directions. These distances are determined by the length of a robot's arm and the design of its axes. Each axis contributes its own range of motion. The more axes that a robot has will increase the size of its work envelope.

It is often possible for a mechanism to move beyond its physical limits, damaging itself in the process. This is why it is often necessary to restrict operating envelopes. Typically, this is achieved with sensors such as limit switches and encoders.

Section 14 will cover the topic of sensors in greater depth.

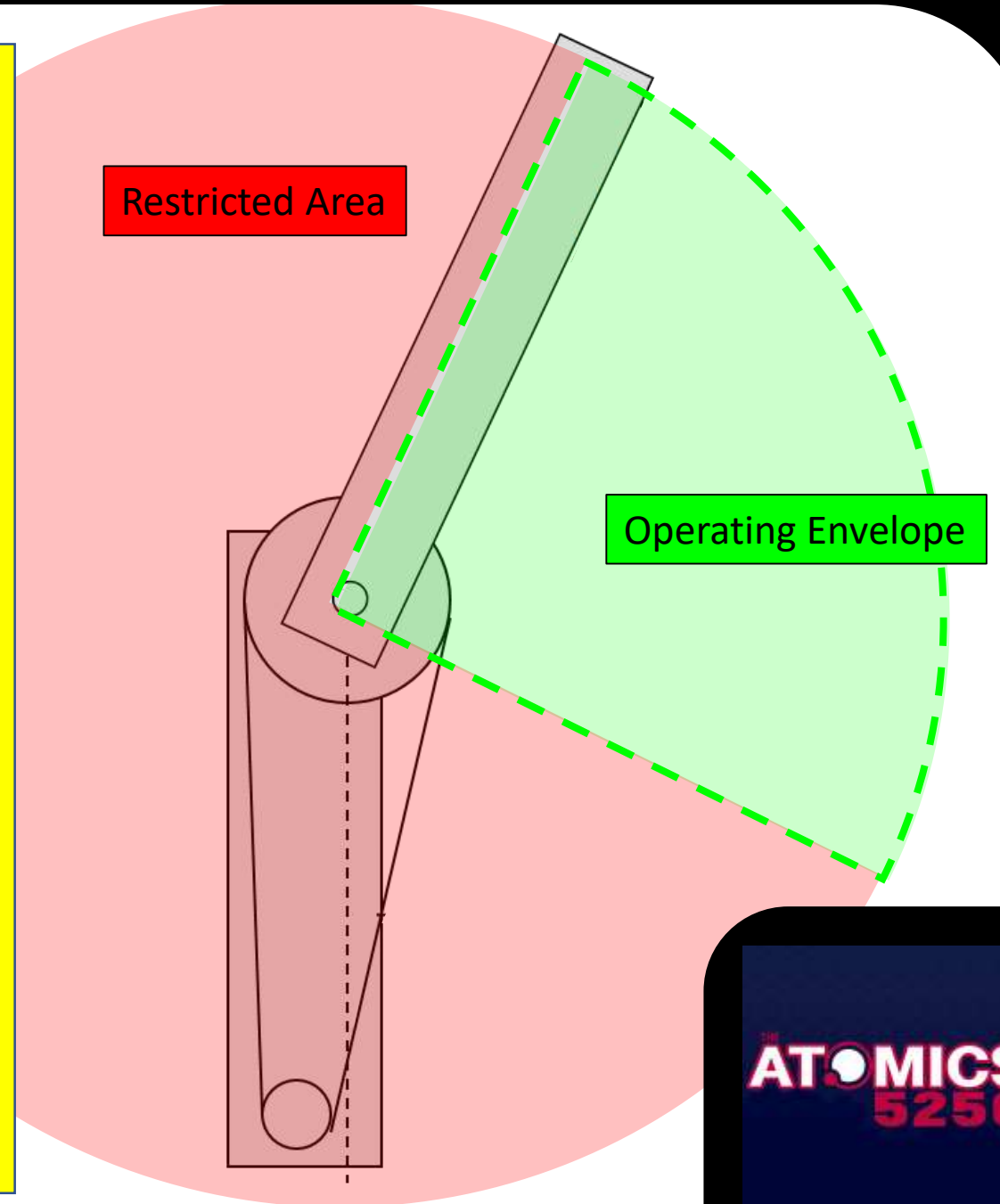



# Arm Design Tips

- Use Lightweight Materials as much as possible
- Design-in sensors for feedback & control
  - Limit switches and potentiometers
- Linkages help control long arms
- Keep things simple
  - Less parts to build or break
  - Easier to operate
  - More robust
- Use off-the-shelf items
- Counterbalance
  - Spring, weight, etc.

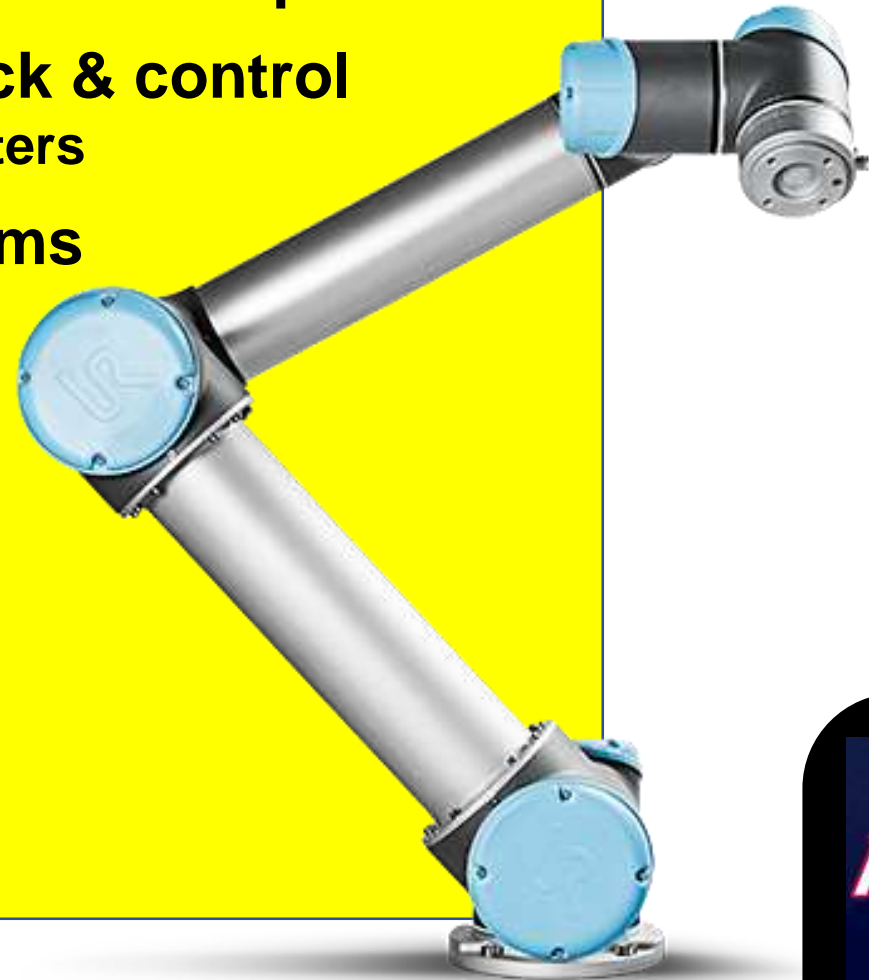

# Four Bar Linkage

A four bar linkage is very similar to an arm but the fourth bar will always remain in the vertical orientation. As a result of the force distribution, the weight applied on the pins/pivots between bars can be very high, and the upper bar will always be tensioned. As a result of the fourth bar, they're limited in rotation. **Both arms and linkages will likely need software or hardware stops to prevent breaking.**

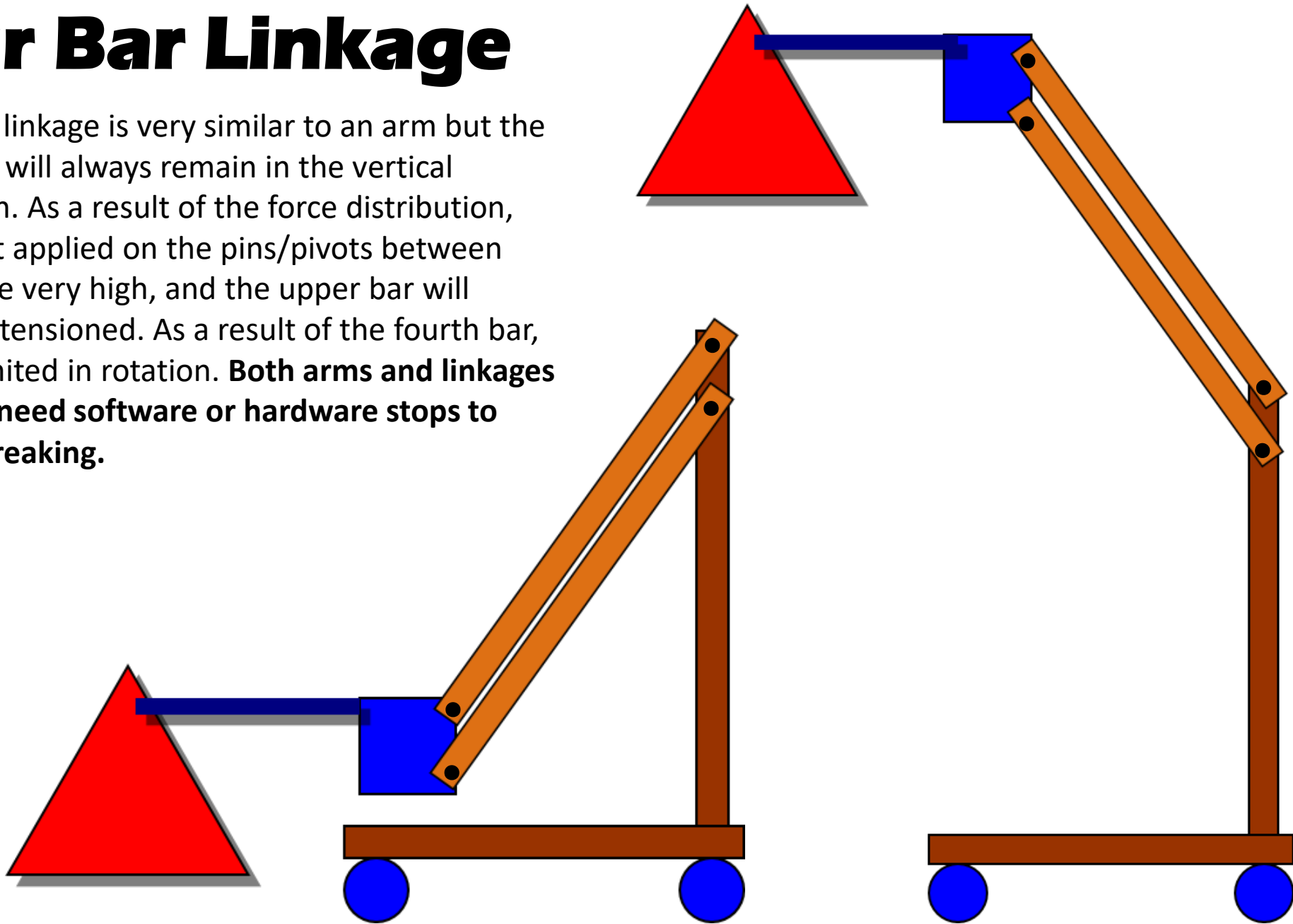



## Four Bar Tips

- **Use Lightweight Materials as much as possible**
- **Design-in sensors for feedback & control**
  - Limit switches and potentiometers
- **Control long arms with linkages**
- **Keep things simple**
  - Less parts to build or break
  - Easier to operate
  - More robust
- **Use off-the-shelf items**
- **Counterbalance to reduce load on motors**
  - Springs, weight, etc.

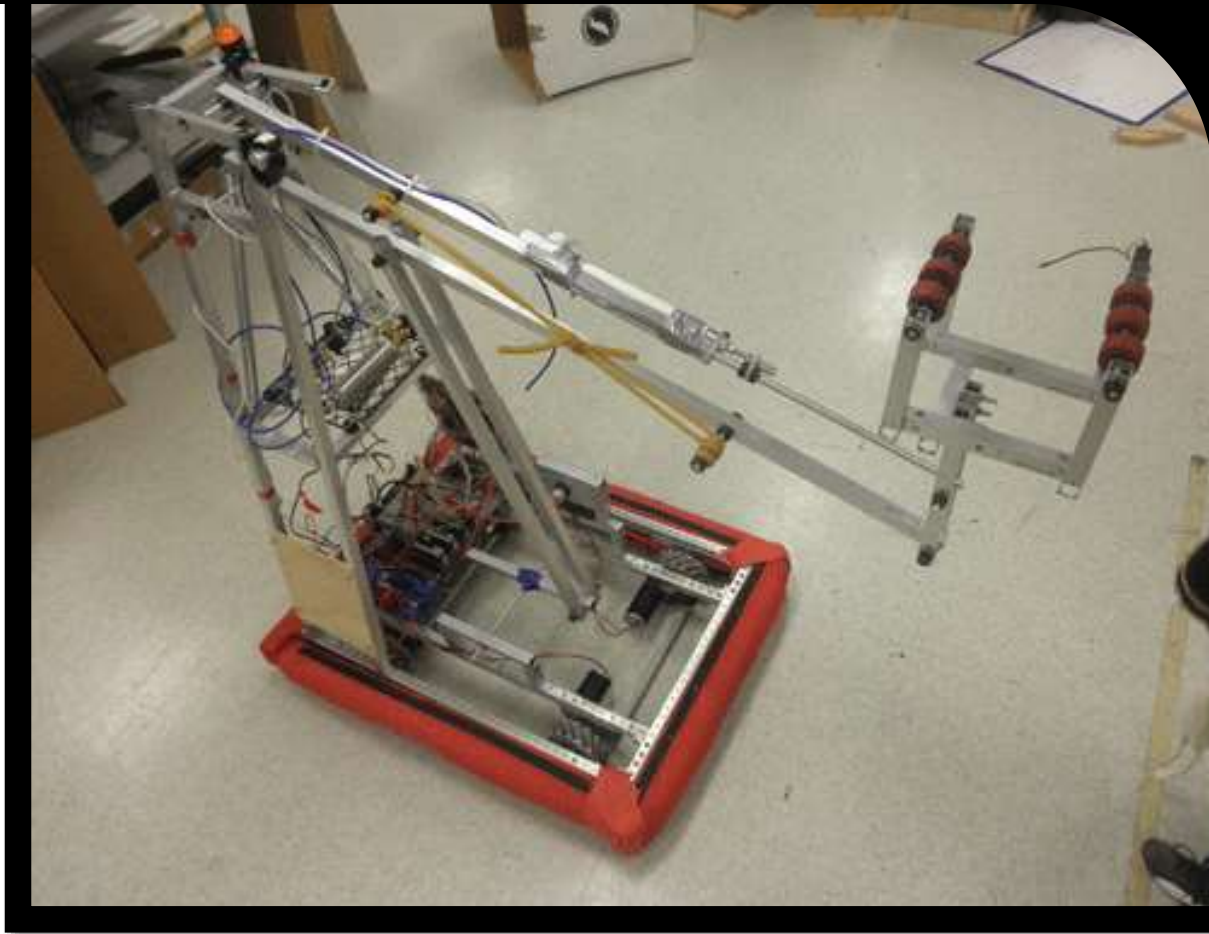



KILLER BEES ROBOTICS - FIRST TEAM 33

BLIZZ XXIII



## Extreme Design – Double Reverse Four Bar

- Cross linked Double Reverse Four Bar design
- Only 41 inches high at rest, over 8 feet tall
- Lifts to full height in one second

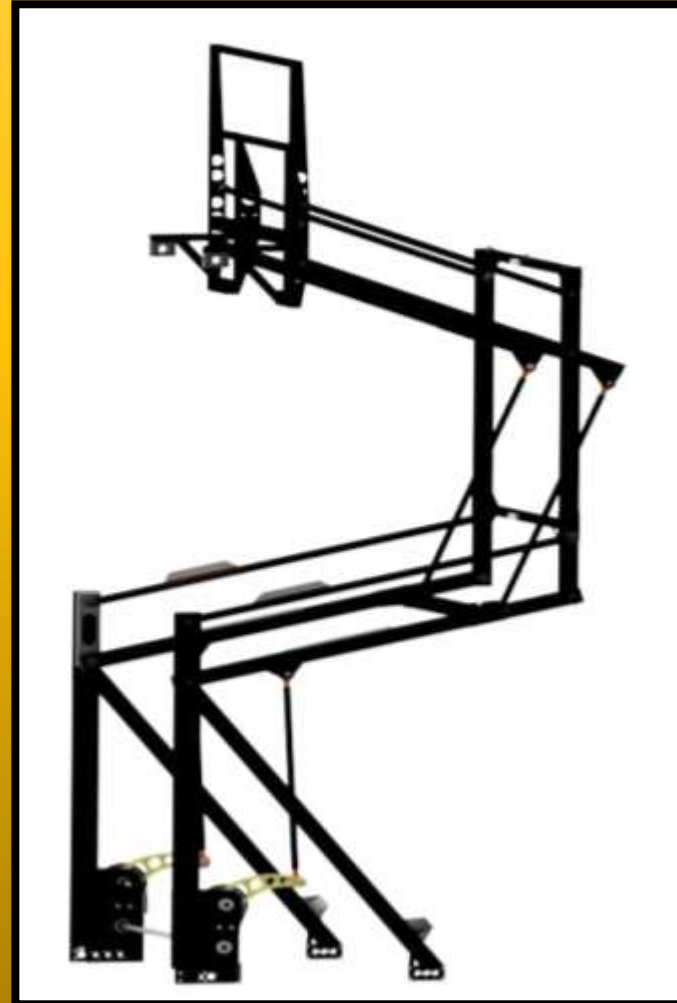



# Elevators and **Lifts**

# Mechanisms

## Lift Elevators

Elevators in FRC enable fast, effective vertical movement and usually consist of the following:

- **Carriage**, *the moving part*
- **Track**, *the stationary part*

### Two Stage Elevators

Depending on the max height for starting position and the objectives of the game, it may be necessary to design a two stage lift like the one shown at right. A two stage lift features an additional intermediate frame section, which both moves within the stationary track, while acting as a track for the carriage.

While a 48in tall single stage lift may only be able to achieve a max height of 85in, a two stage lift could potentially reach 10ft or more.

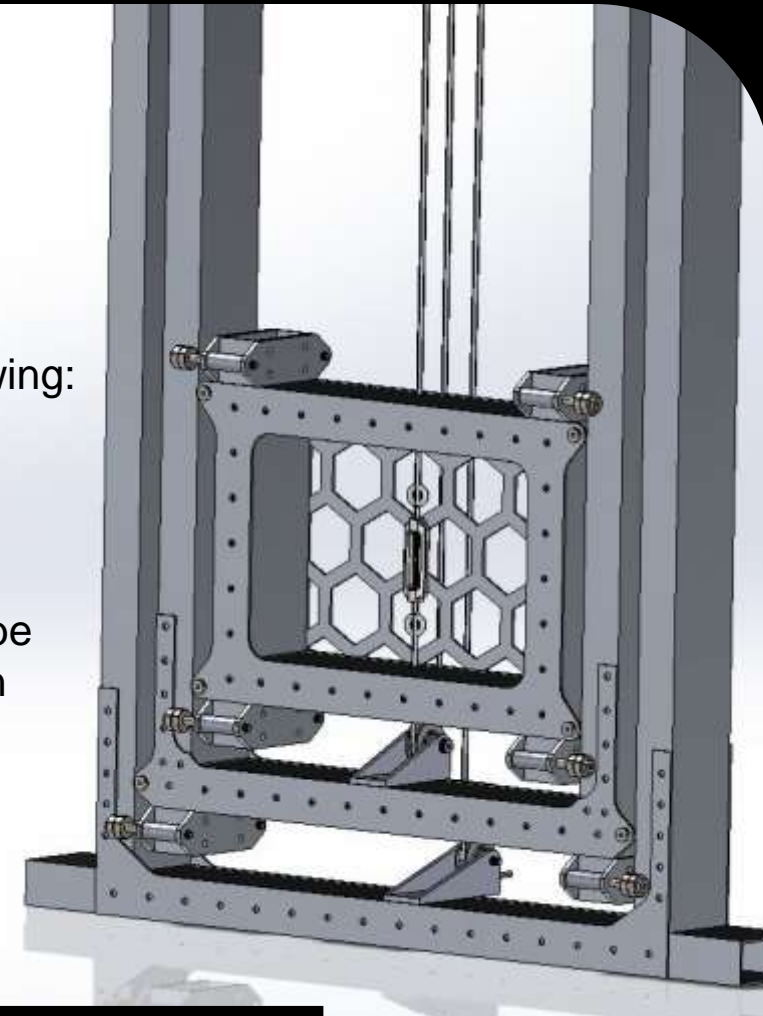

**Pro Tips:** Regardless of which approach you take, building a successful lift elevator requires adhering to a few best practices:

1. **Build with precision, ensuring the slides are robust, yet slide freely**
2. **Find the overlap sweet spot between stages without causing wobbling**

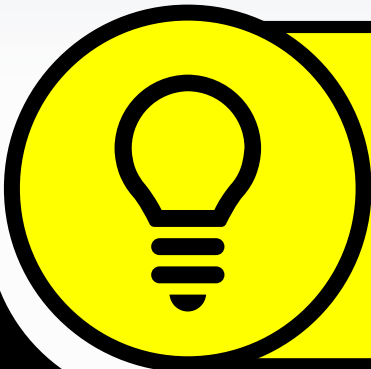

# Mechanisms

## Continuous Lifts

- Cable Goes Same Speed for Up and Down
- Intermediate Sections sometimes Jam
- Low Cable Tension
- More complex cable routing
- The final stage moves up first and down last

### Pros:

Reduced load on motor; Simple drum design; Lightweight cabling.

### Cons:

Slower lift operation; Final stage moves up first and down last; Potential for jamming; Cable routing is more complex.

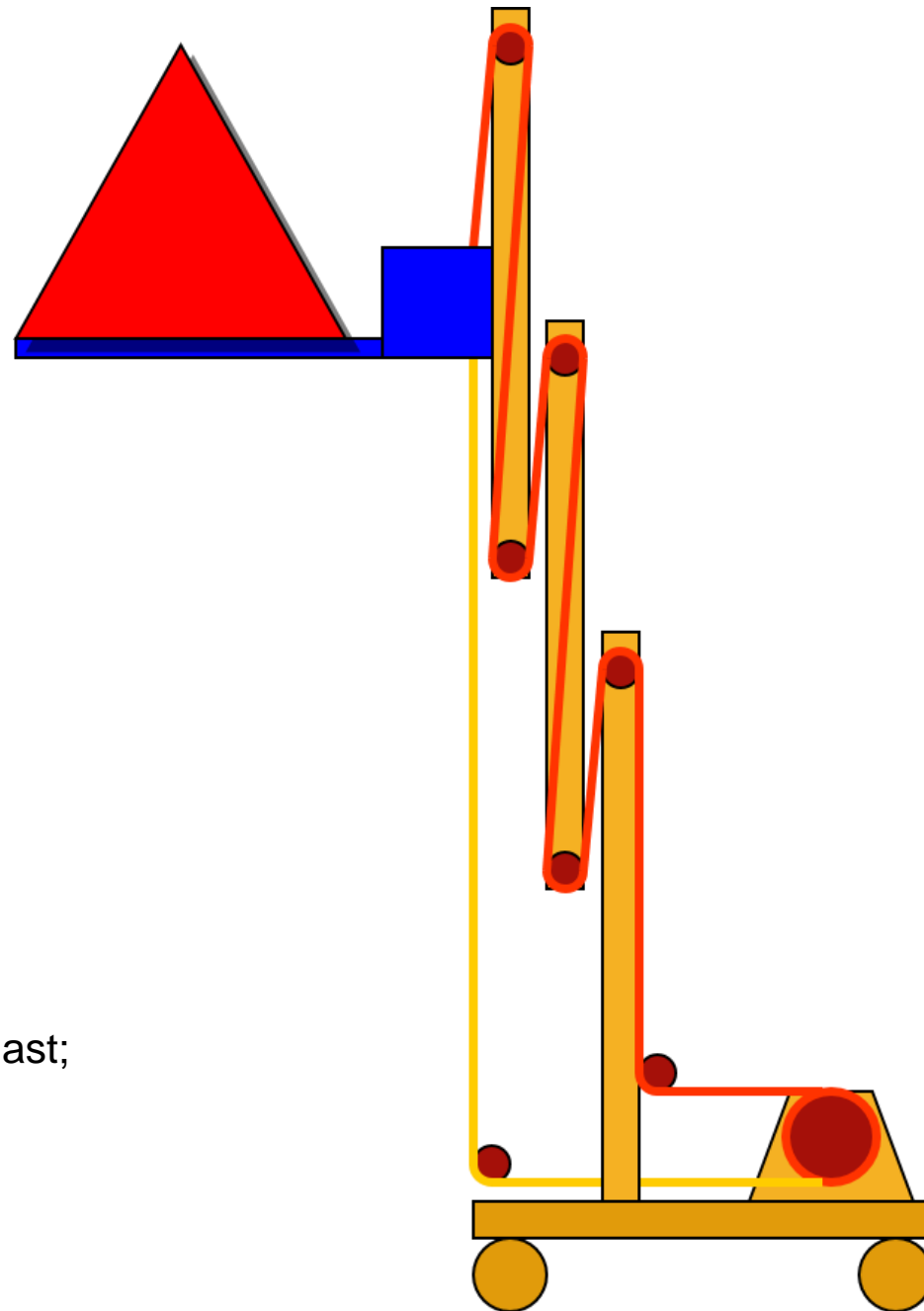

# Mechanisms

## Cascading Lifts

- First stage is raised using a pulley and drum system, while subsequent stages are tethered as shown in the drawing at right.
- All stages extend simultaneously, resulting in different cable speeds which must be handled with different drum diameters or Multiple Pulleys.
- Load placed on the motor is about double the actual weight of the lift.

### Pros:

Faster lift operation; Middle stages less likely to jam; All sections extend simultaneously; Lightweight cabling.

### Cons:

Greater load on motor; Increased complexity with drum sizing; Cabling must be maintained regularly.

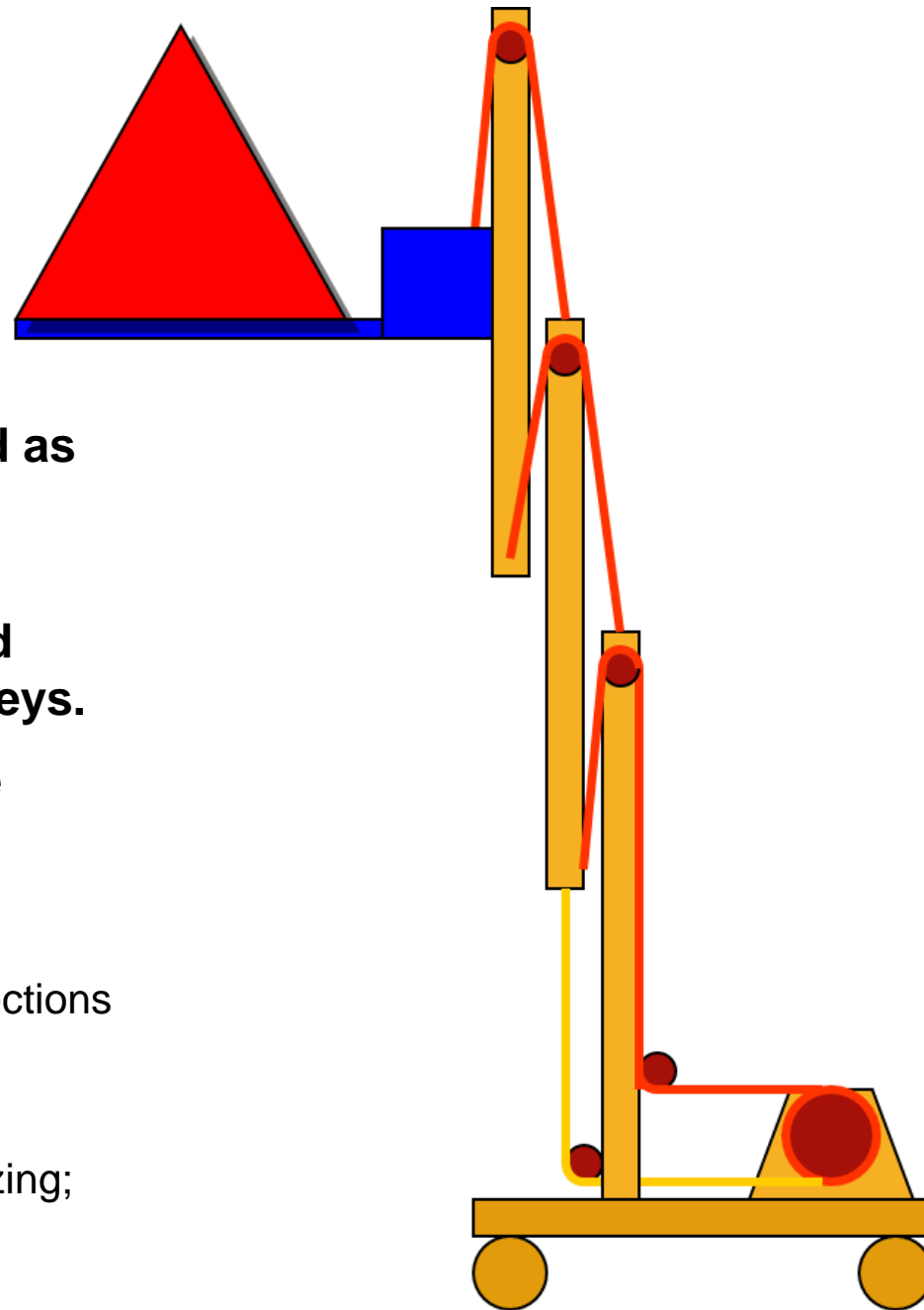



## Elevator and Lift Tips

- Most error and slop/play comes from the slides, so put time and effort into these to ensure they are robust and reliable yet slide freely.
- Test the design for how little overlap you can get away with between stages while still having the end effector not wobble.
  - *20% is a good starting point for minimum overlap at full extension, more needed on bottom, less on top—Much like laying a good foundation before building.*
- There are two ways to rig an elevator: continuous or cascade.
- Drive cables up AND down or have some way to force the system back down.
- Add adjustable cable tensioners to take out slack over time.
- Precision needed for manufacturing slides and moving stages.
- Consider adding a break to the system (dynamic braking with motors is ok if the motors can handle the load, otherwise physical breaking is required).
- Add sensor feedback (Such as Hall Effect sensors or limit switches) to prevent damaging the structure by overtravelling.

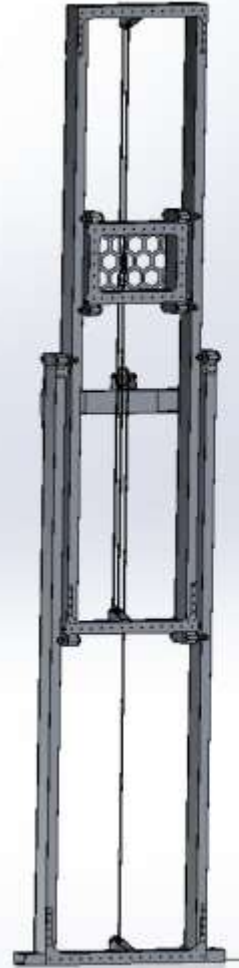

# Mechanisms

## Rack & Pinion

- The rack is attached to one linear slide,
- The pinion (Power driven gear) is attached to the other slide.
- The driven gear must be mounted where the linear slides always overlap.

### Pros:

Robust and precise operation.

### Cons:

Heavy.

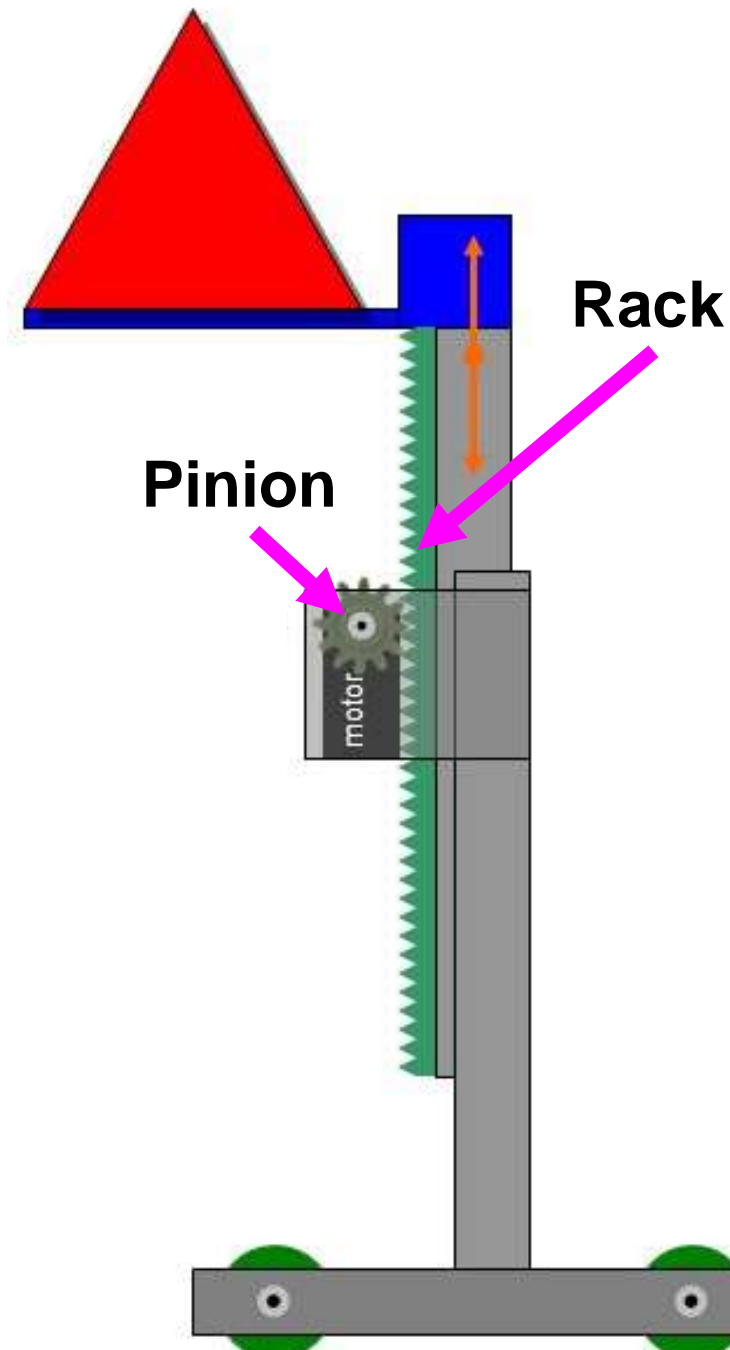

# Mechanisms

## Scissor Lifts

Scissor lifts are a large number of independent linkages bound together to reach high areas. Unfortunately, they typically don't handle side loads very well, as affected by moving your robot. Usually not an ideal vertical mover.

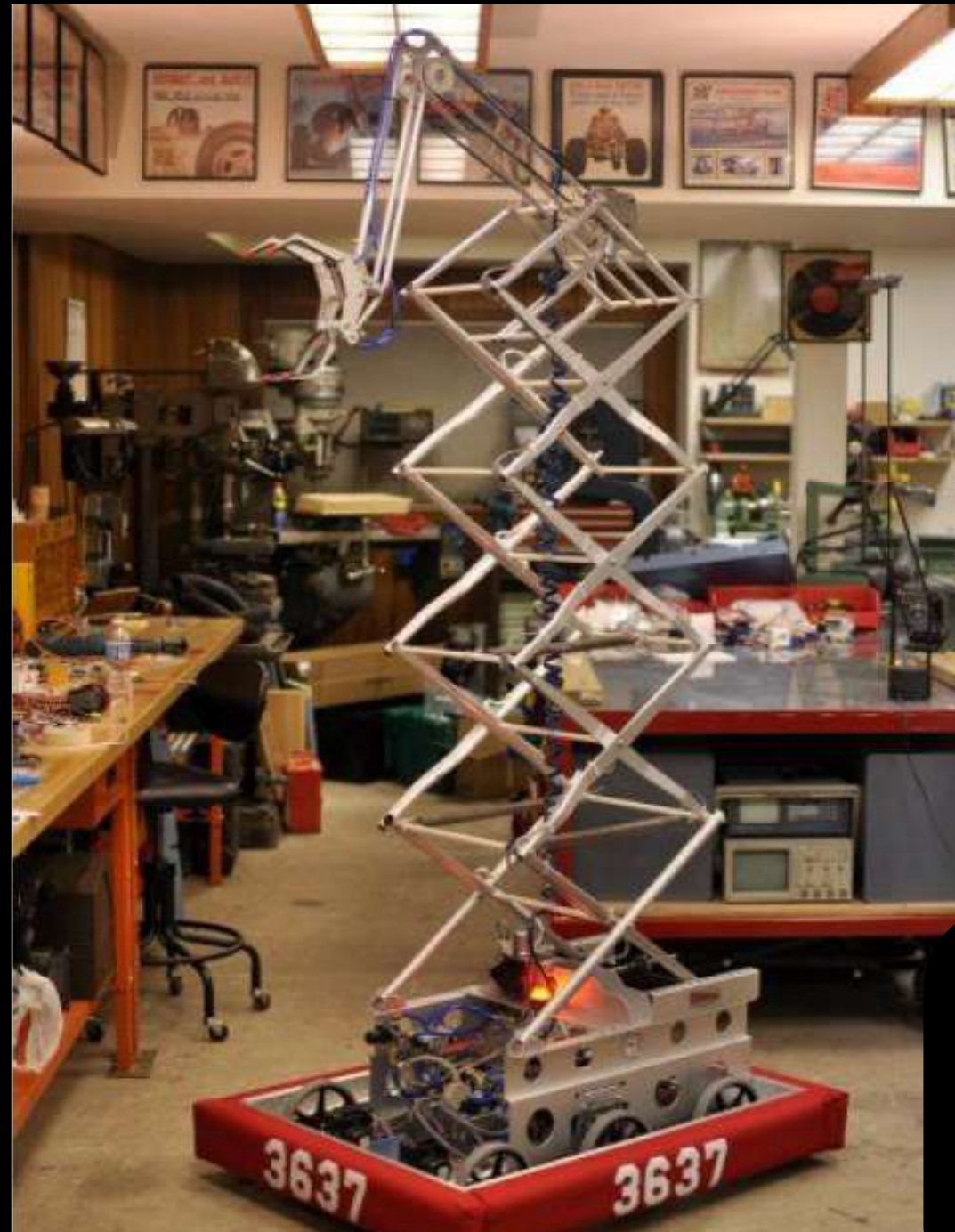



# Mechanisms

## Scissor Lifts

- When the bottom of the scissors is pulled together it extends upwards.
- In the example shown at right, a rack and pinion pulls the bottom of the scissors together.
- Scissor lifts work much better with smaller FTC robots than with FRC robots.

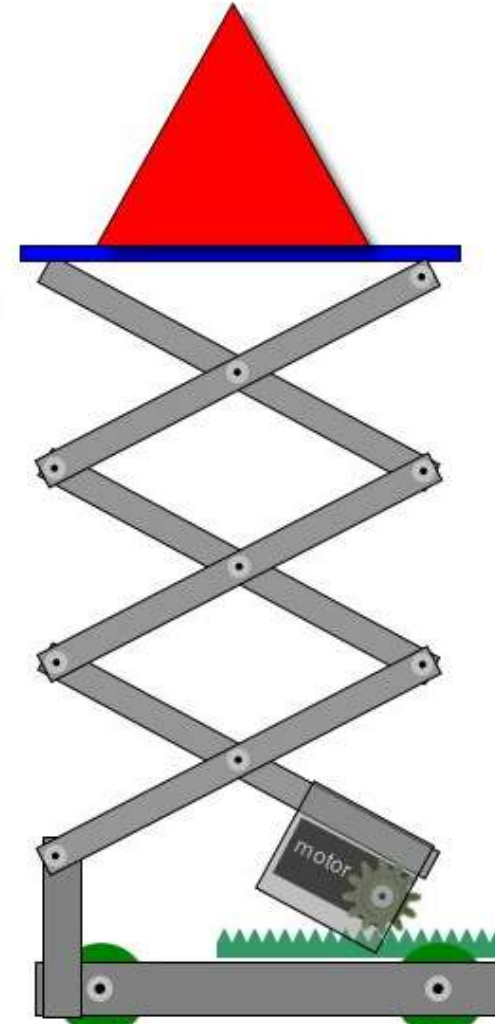
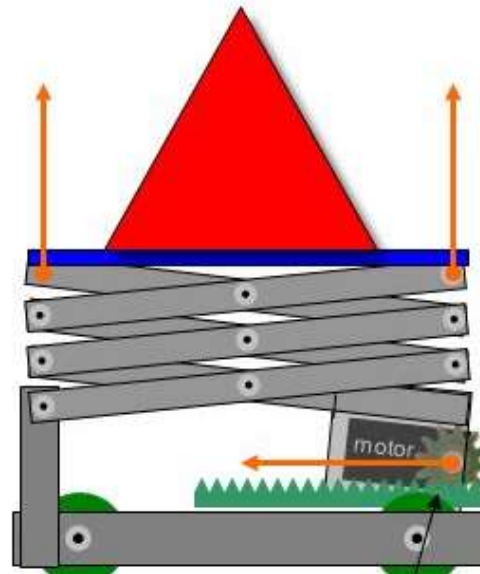

# Mechanisms

## Scissor Lifts

### Pros:

- Minimum retracted height - can go under field barriers

### Cons:

- Tends to be heavy to be stable enough
- Doesn't deal well with side loads
- Must be built very precisely
- Stability decreases as height increases
- Loads very high to raise at beginning of travel
  - **NOTE: This problem can be bypassed by lifting at the pivot directly above the fixed point, causing the leverage/gear ratio to become constant.**

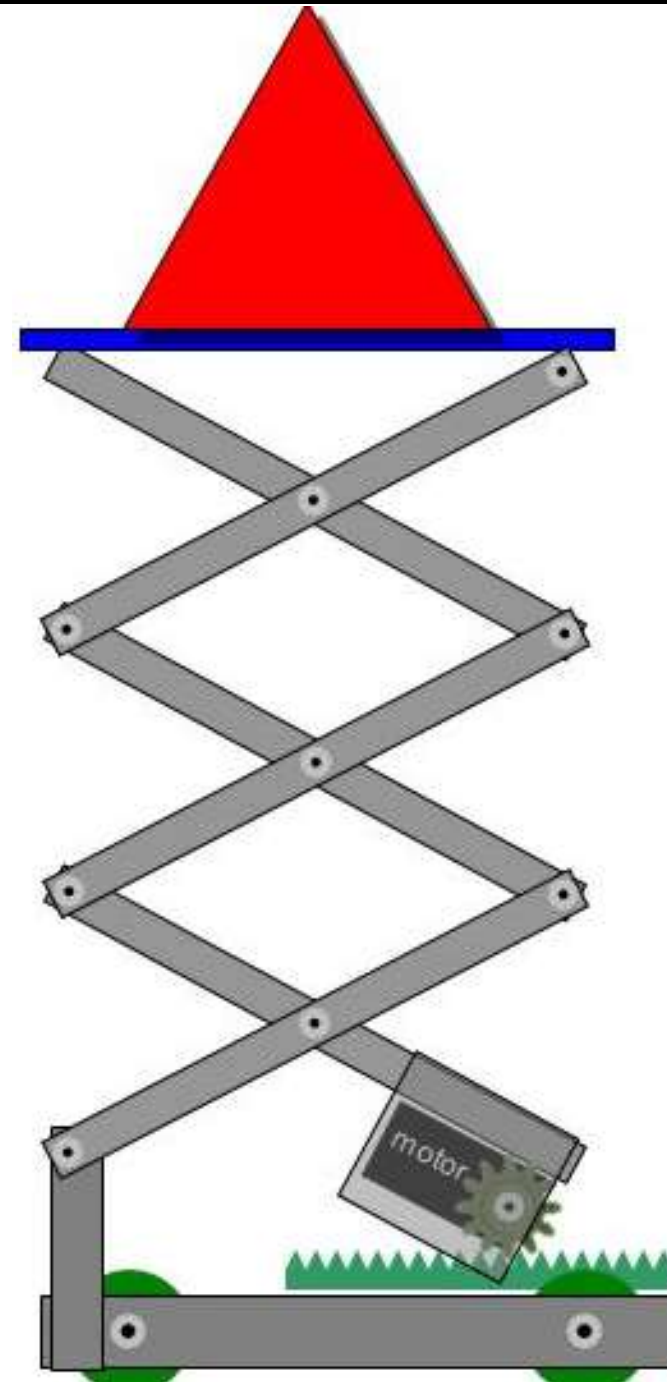



## Lead Screws

Translates rotation into linear motion. Screw threads tend to transfer energy more inefficiently than other linkages due to

frictional losses, allowing lead screws to remain locked in position when not being driven. This makes lead screws ideal for applications such as scissor lifts and CNC machines.

### Pros:

- Precision
- Locking
- Relative Simplicity

### Cons:

- Often Slow
- Weight
- Size
- Fragile

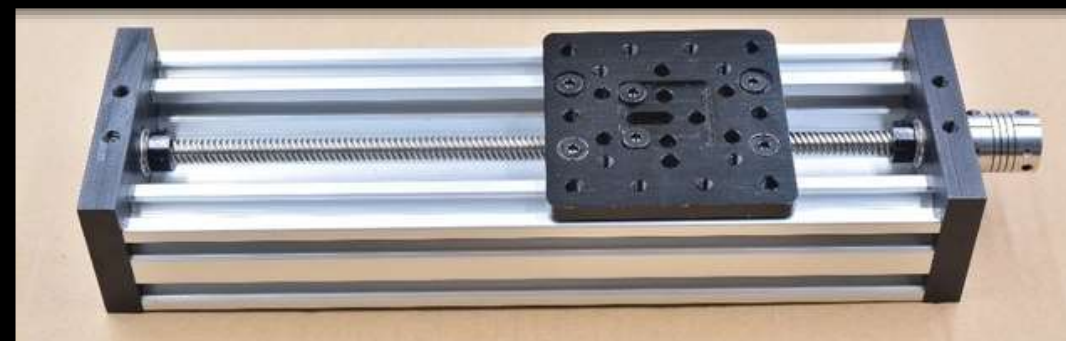
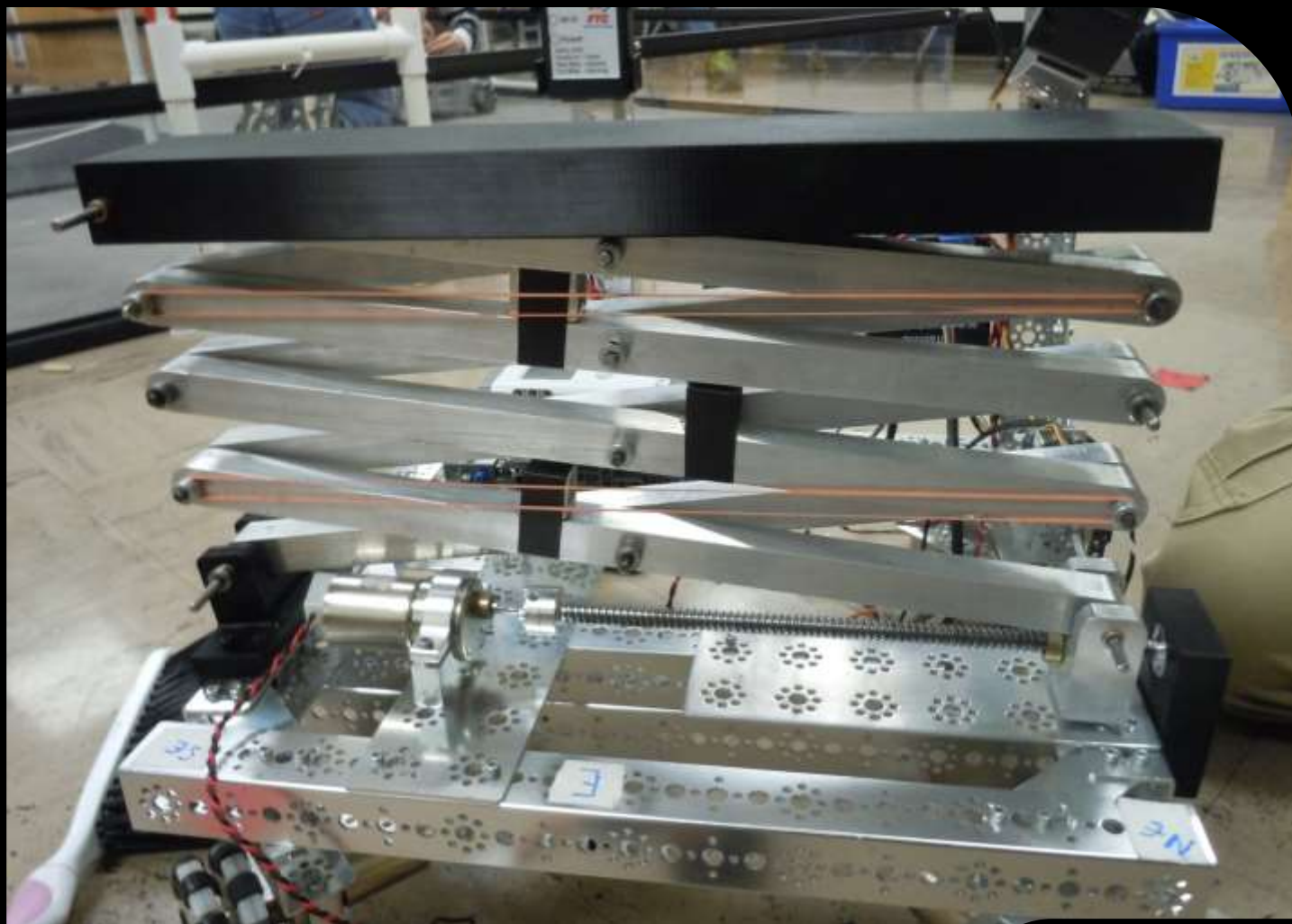



## Ball Screws

Translates rotation to linear motion with little friction. Can also be used to translate linear motion to rotation. Ball screws are different from Lead screws in that their threaded shaft acts as a helical raceway for ball bearings. While this seemingly acts much the same, Ball screws can apply or withstand high thrust loads and have minimal internal friction, which allows them to move freely when not under power.

### Pros:

- Precision
- Back drives easily (assuming you want that)

### Cons:

- Noisy
- Complicated
- Back drives easily (If you don't want it to)



You probably won't see any teams using ball screws in FRC, but knowledge is power, amirite?



# Hybrid Designs

# Mechanisms

## Arm Connected to the Final Stage of an Elevator

Fairly common, great for large vertical reach when a smaller horizontal reach is needed. They can also reach over obstructions in the robot, such as the frame perimeter (many teams opt for this type of mechanism simply to fit within the starting size requirement).



# Mechanisms

## Telescoping Arm (Pivoting Elevator)

Great when both horizontal and vertical reach is needed. It's a bit more complicated because all of the cable rigging and structure rotates but it can be done with success.

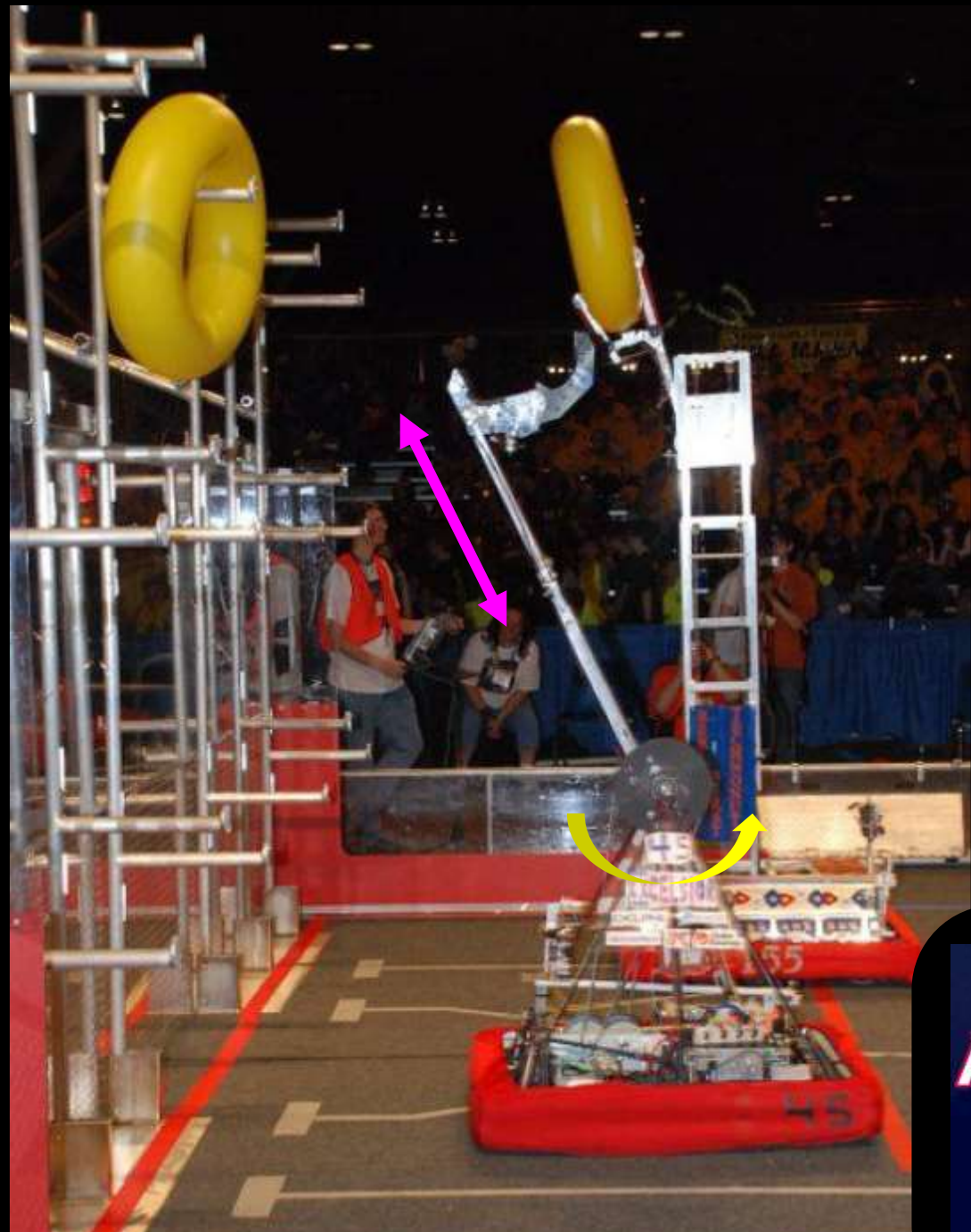
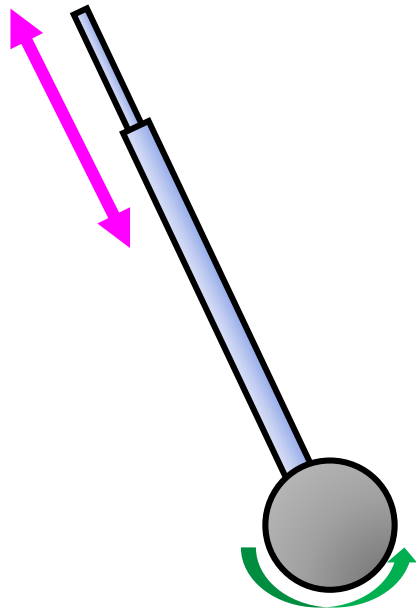

# Mechanisms

## Multiple Elevators (Different Directions)

Depending on the setup for the middle stage this can give you one of the largest areas of reach for the end effector. It will also keep the end effectors orientation constant throughout its travel. However it's very complicated with lots of moving parts so be careful!

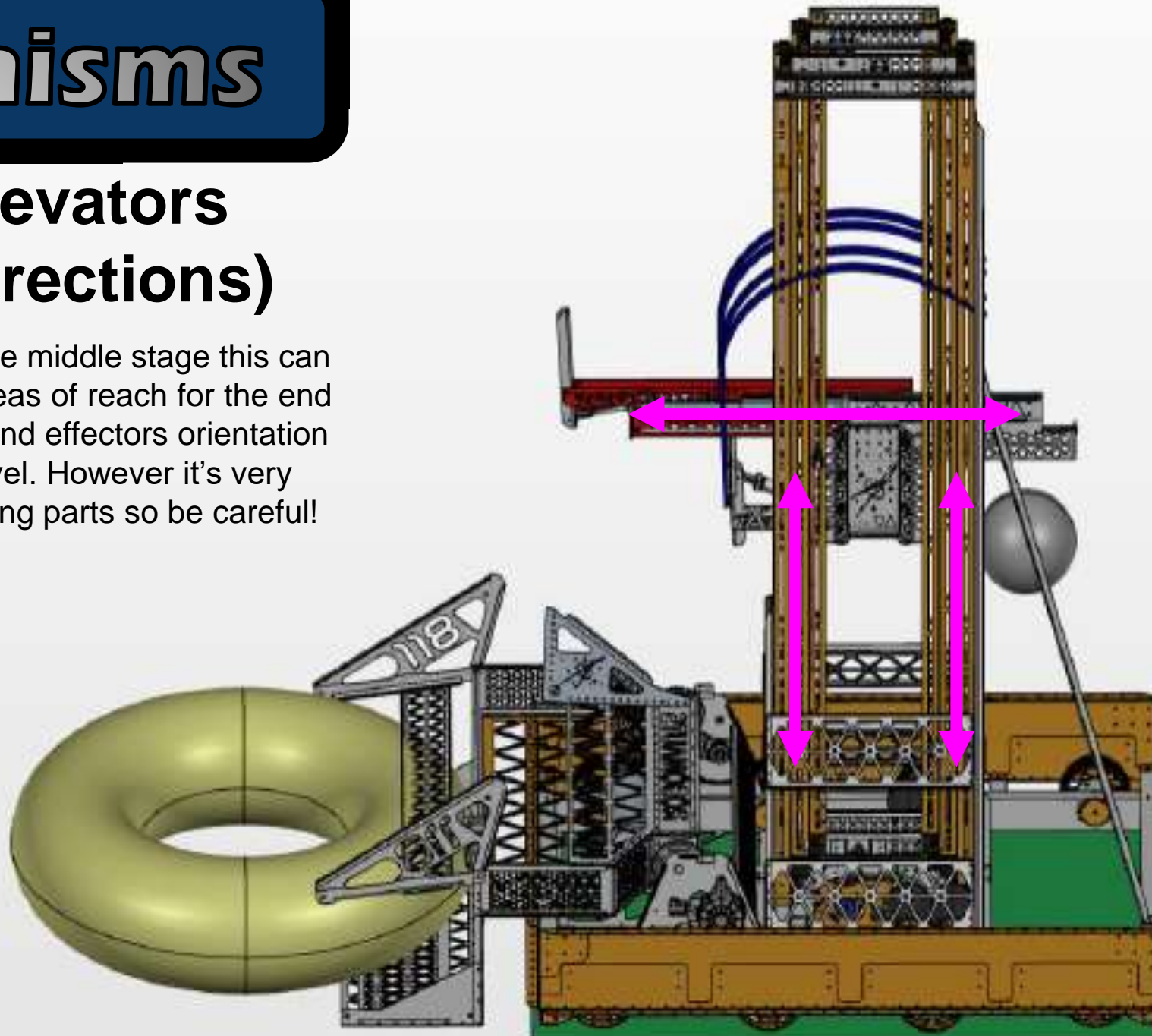



# Section 5: Mechanisms

## Skills



Comprehend the underlying physics governing articulated arms.



Know how lift elevators work under different rigging systems.



Understand the function of the main components in a 4-Bar Lift.



Recognize individual mechanisms when used together in a hybrid design.

## Review Questions

1. Which mechanism consists of a bar, pivot point, and actuator?
2. What are some differences between cascading and continuous lift elevators?
3. What are some ways of translating rotation into linear motion?

## Section 6

# Manipulators & End Effectors

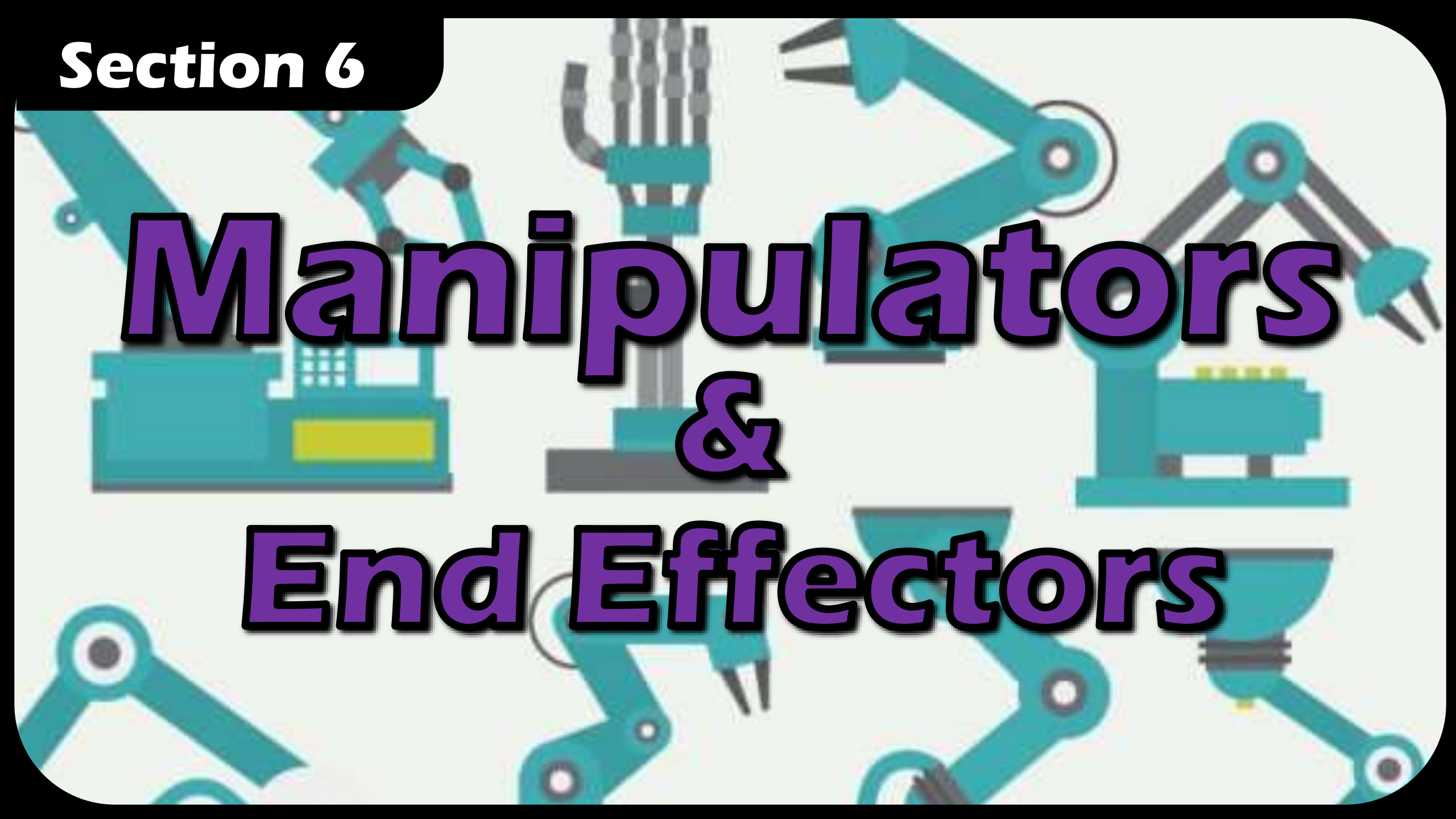
The background features several stylized illustrations of robotic arms and end effectors. The arms are primarily teal with grey joints and bases. Some end effectors include grippers with two fingers, while others are more complex, resembling specialized tools or sensors. The overall aesthetic is clean and technical.

# Manipulators and End Effectors

End effectors of a given robot are the pieces that interact with the field and game objects. It's important to understand that end effectors are specialized objects designed for a given game (typically). Robots can have more than one end effector, or can evolve in terms of end effectors over the course of a given season.

The goal of any end effector is to quickly and effectively own and manipulate game objects, whether that means grabbing, scoring, storing, or holding as you move about the field.

For the purposes of this section the major classes of manipulators include:

- **Things that grasp**
- **Things that move things**
- **Things that store**



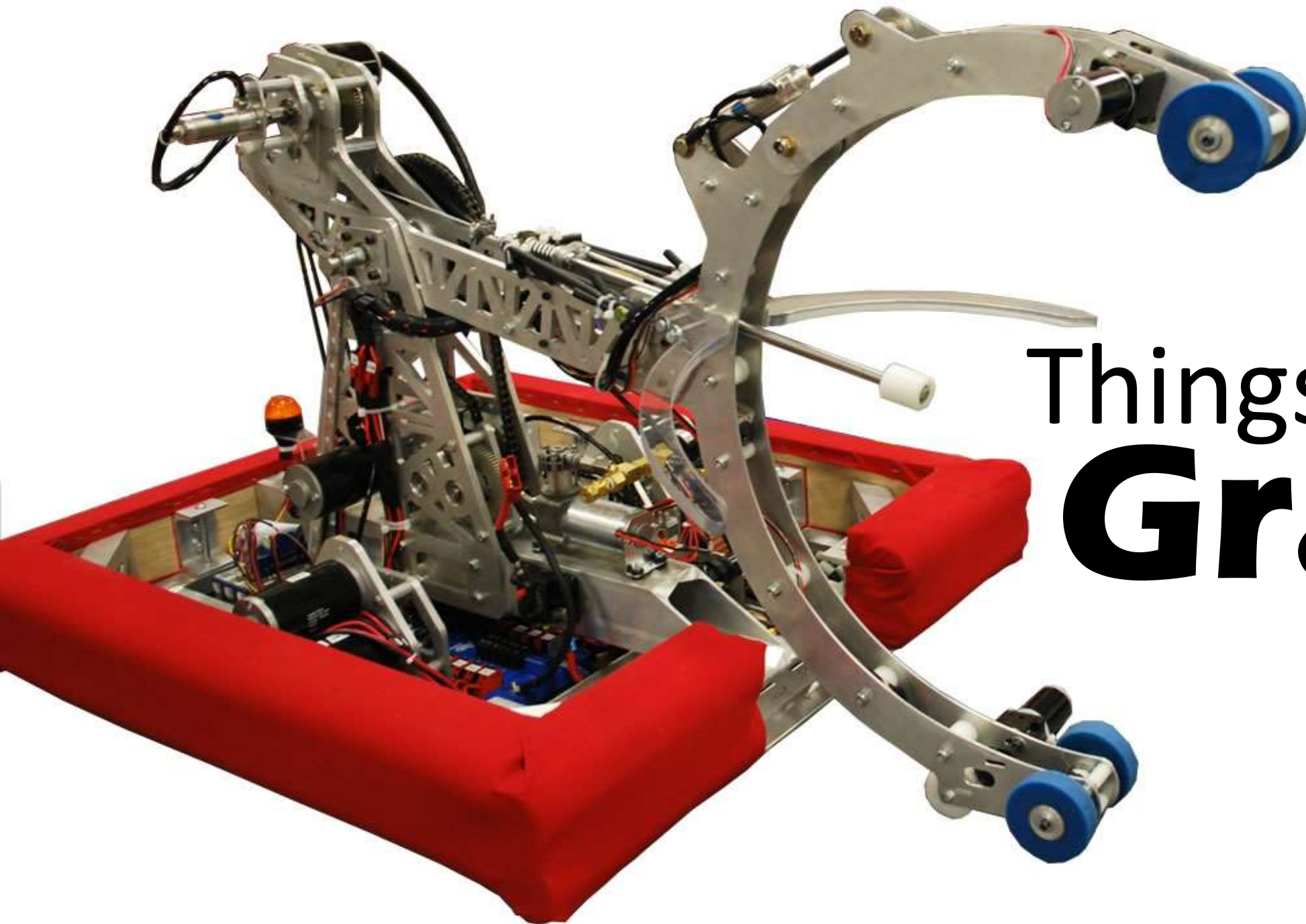

# Things that **Grasp**

# Manipulators

## Roller Claws

Good manipulators combining rotary motion and the grabbing properties of claws. With articulation, are incredibly effective methods of holding game pieces, and are relatively simple to build.



# Manipulators

## Articulated Roller Claws

Same as roller claws, except articulated in ability to open up jaws of intake. Typically articulated using motors or pneumatics depending on the situation.

Sometimes roller claws are passively articulated, using something like surgical tubing to hold it closed as an item is grabbed.

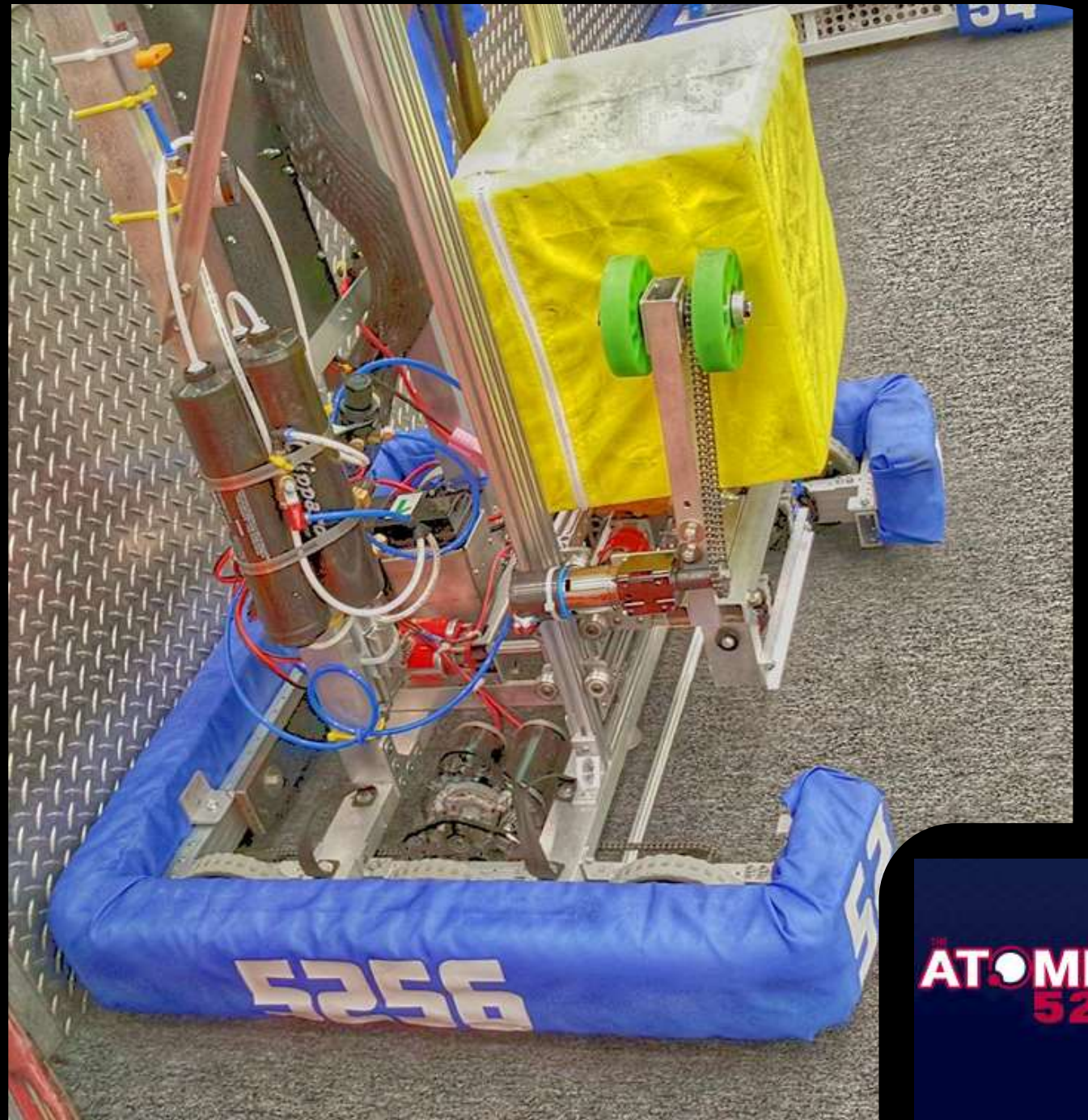

# Manipulators

## Vacuums

By applying negative pressure on a game piece, one may be able to more effectively control it. Difficult to implement, and not always effective at owning game pieces, vacuums suck (no pun intended). The 2018 game probably saw more vacuums in competition than any other year due to the COTS solutions like Armabot's AmvaVac (shown below).



# Manipulators

## Latches

Hooking and latching mechanisms enable secure grasping of field elements, like goals and bars. Two major varieties exist, of “simple” which have no way to release, and “smart” latches which can be remotely released (typically with servos).





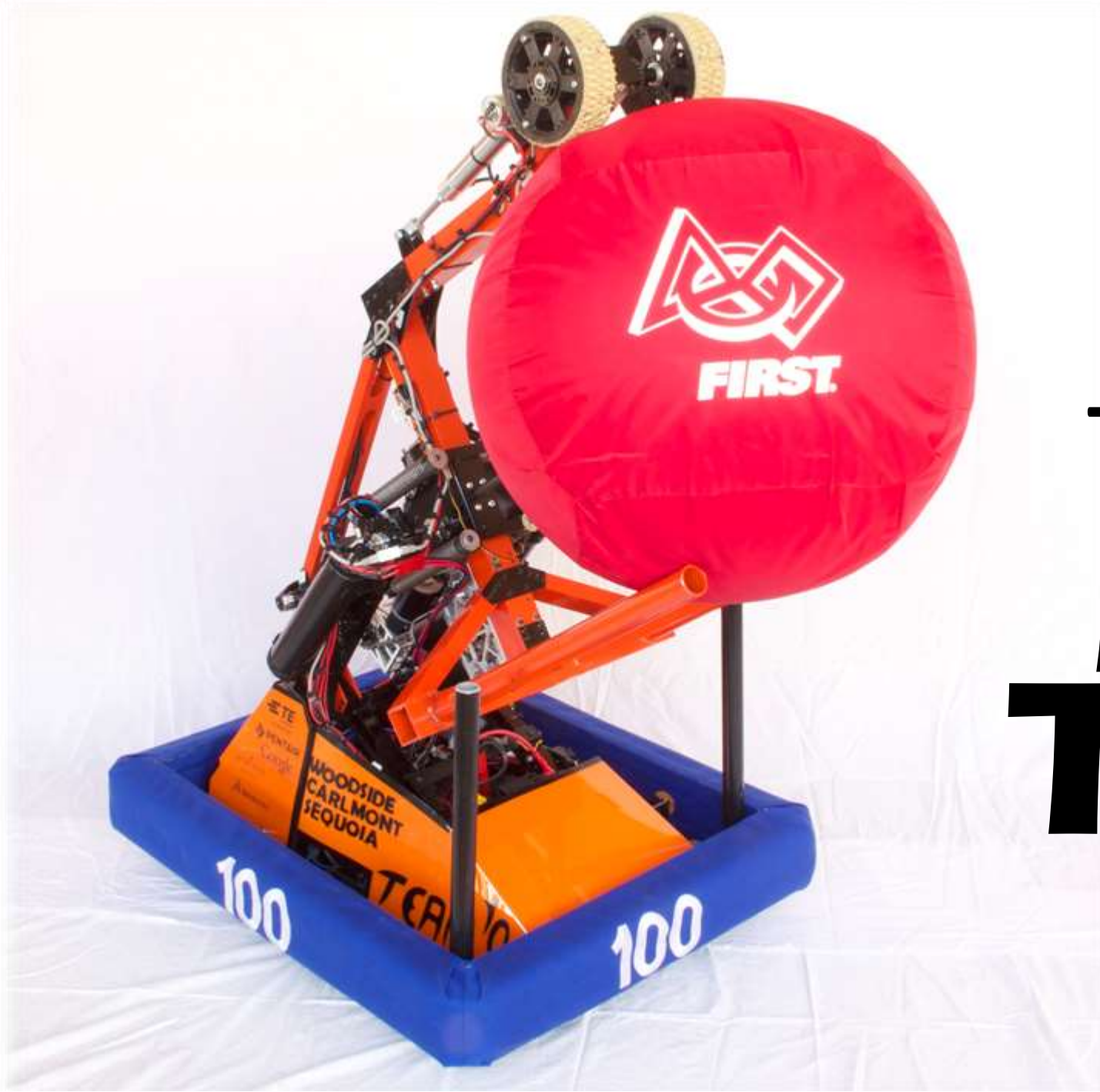

# Things that **Move** **Things**

# Manipulators

## Rollers

Great for intakes, transporting or storing balls or other game pieces. Belts are good for small, single file paths, with roller cord being good for wider paths. More control is better, and as such knowing that gravity based feeds will jam. In addition, the physical properties of game pieces may evolve or degrade over the course of competition (under-inflated tubes, damaged boulders, broken fuel).

### Pro Tips:

- **Ball intake rollers should spin at about double the max robot speed.**
- **Material durometer of compliant wheels should be rated for the RPM of the intake.**
- **If using a shooter, it should match or double the intake RPM (your mileage may vary depending on ball types and other factors).**

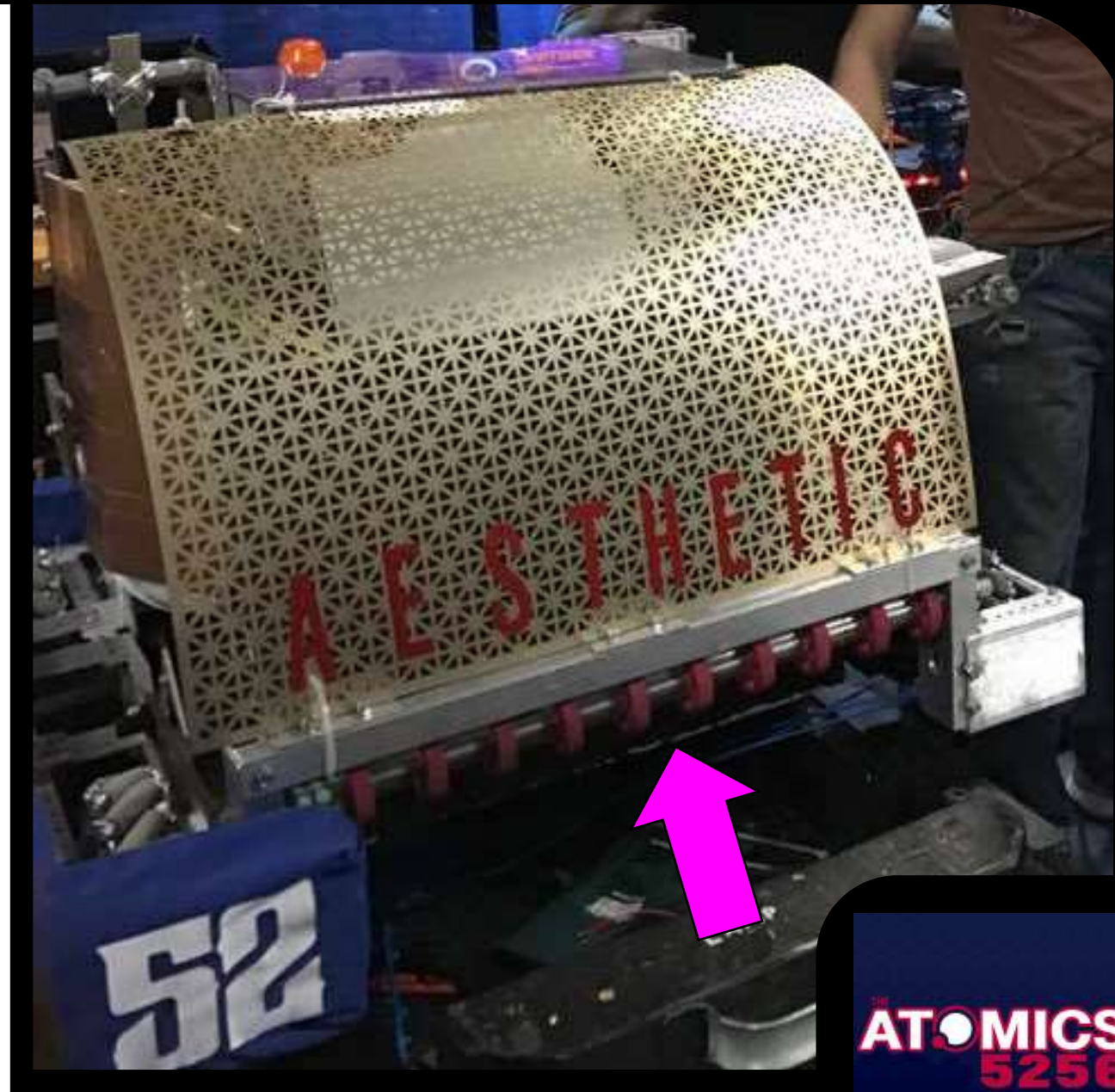

# Manipulators

## Shooters

Relatively simple and reliable. When building, teams must ensure that the opening is big enough for game pieces, but the roller must be able to touch game pieces to move them. Proper compression must be ensured, as well as funneling of game pieces to ensure not jamming.

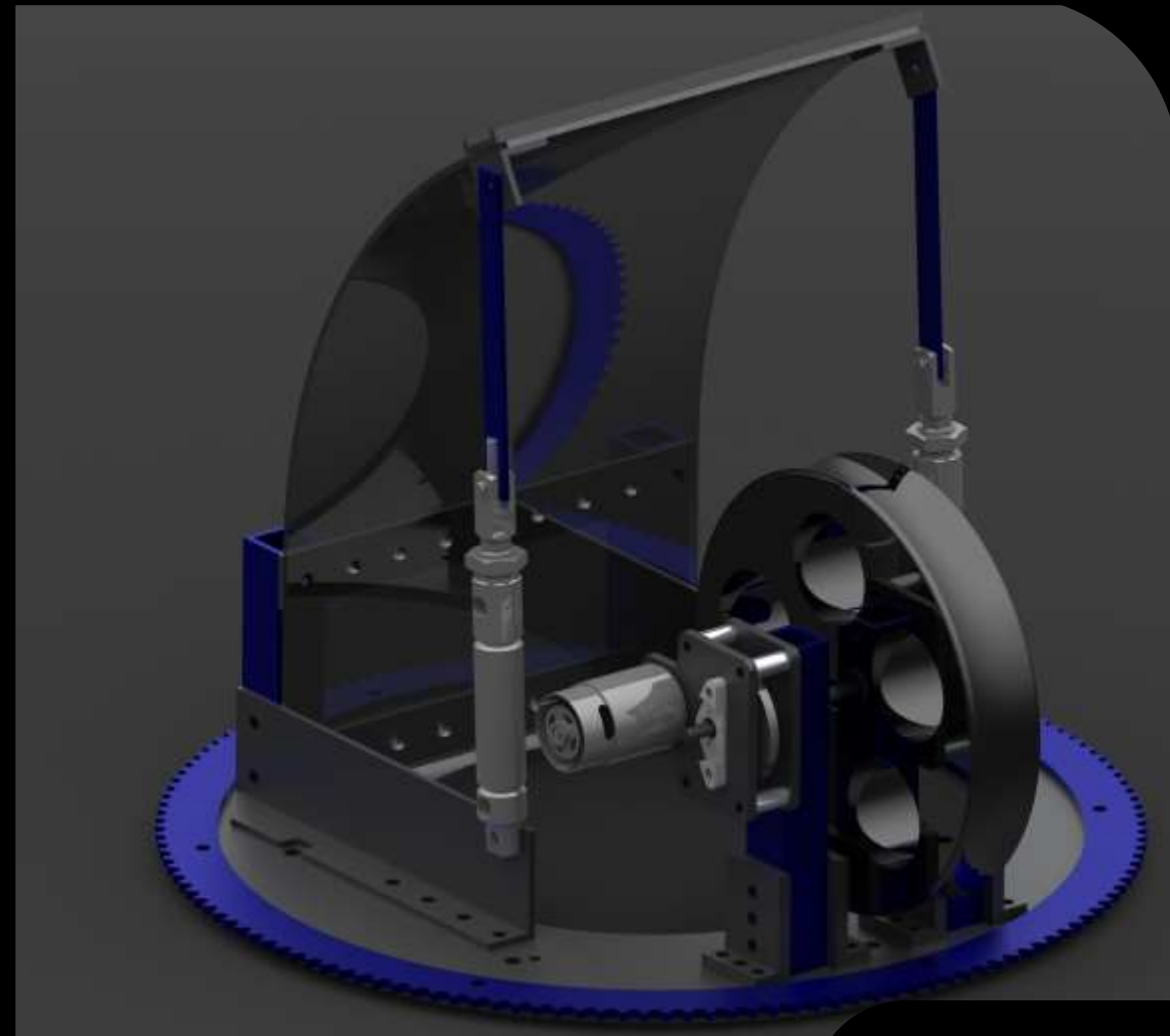

# Manipulators

## Single Wheel Shooter

- Distance can be varied by changing wheel speed or changing angle of guide rail.
- Spin is constant.
- Wheel needs to be mounted vertically.

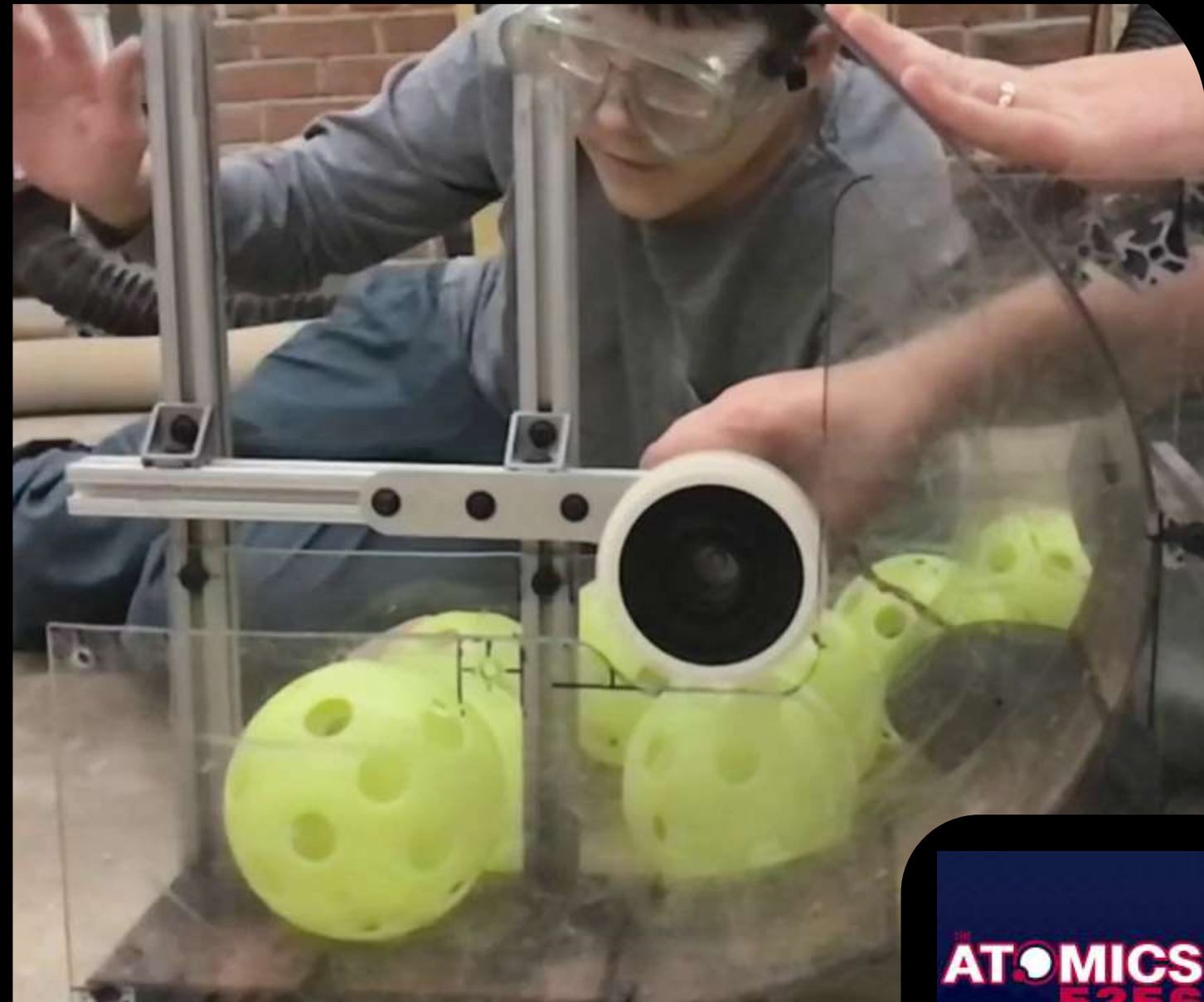

# Manipulators

## Two Wheel Shooter

- Distance is determined by speed of wheels.
- Spin can be varied by relative speed between two wheels.
- Wheels can be mounted vertically or horizontally.

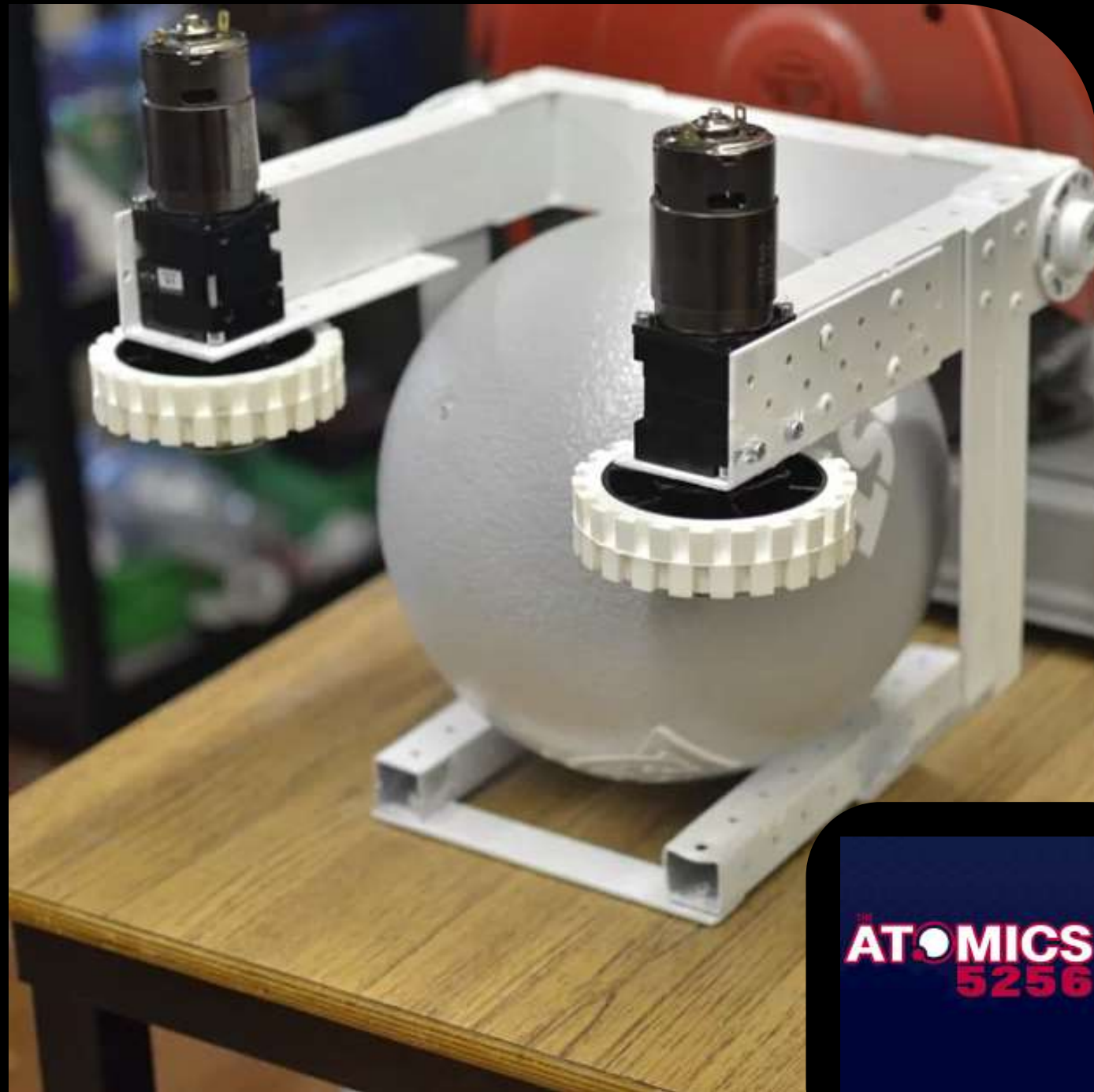

# Manipulators

## Catapult

By using tension paired with a long lever arm, launching game pieces is a slow but effective way to consistently score, depending on the game.

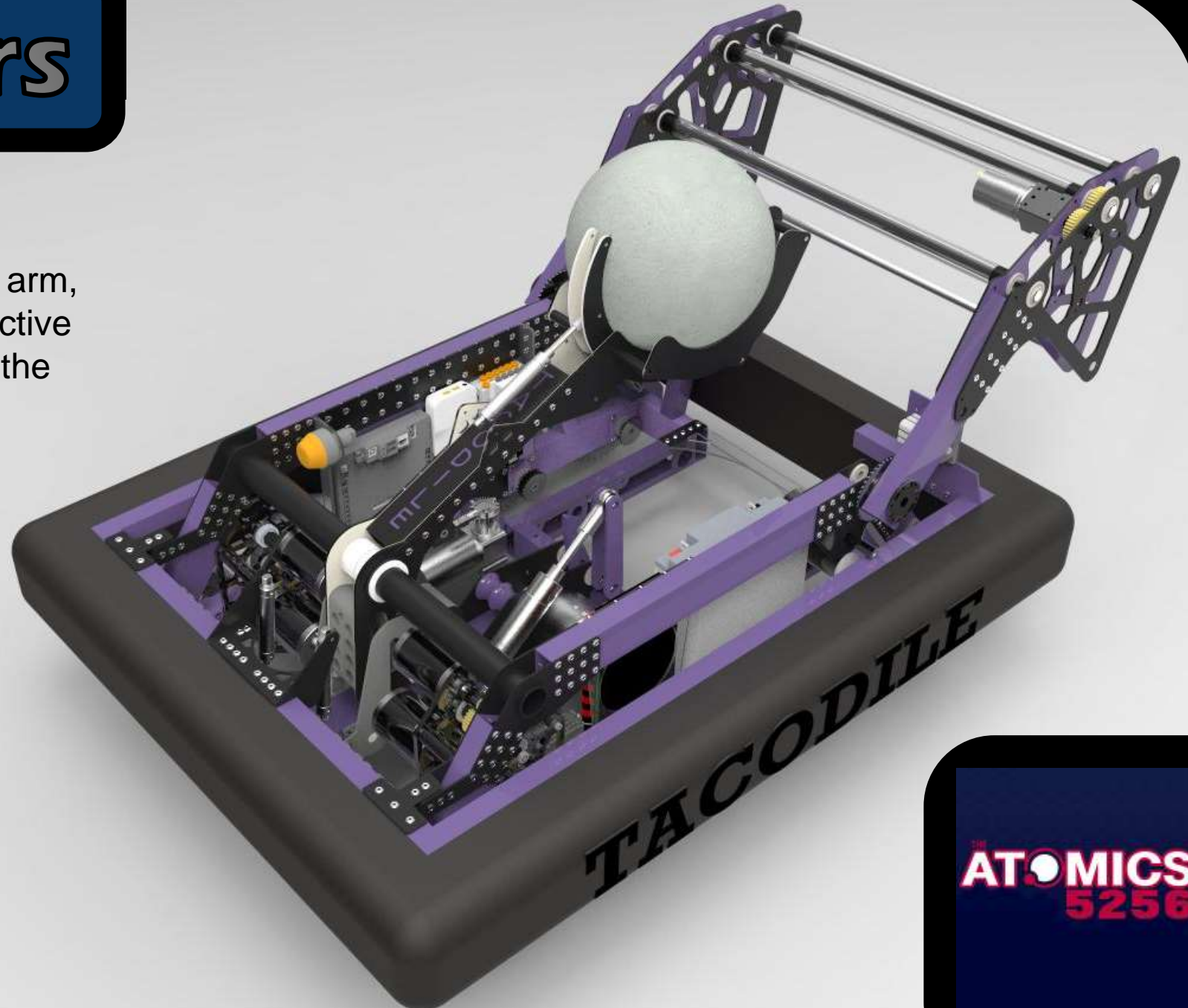



# Things that **Store**

# Manipulators

## Hoppers

A massive bin of game pieces are a staple of traditional FRC design, especially in the “golden era” where shooter games were common. However, serializing the game objects was a major issue and as such, hopper design circulated around it. Some teams achieve this by copying a “dye hopper” design from paintball guns, but this isn’t always necessary.





# Manipulators

## Helical Hoppers

Use a high speed brusher core to move balls up and around a central helix, but stores lots of balls in a single file line, at regular intervals at known locations.



# Manipulators

## Vertical Hoppers

Very similar to a traditional hopper, except the game pieces are stacked one on top of the other, not effective in games with normally shaped game pieces.

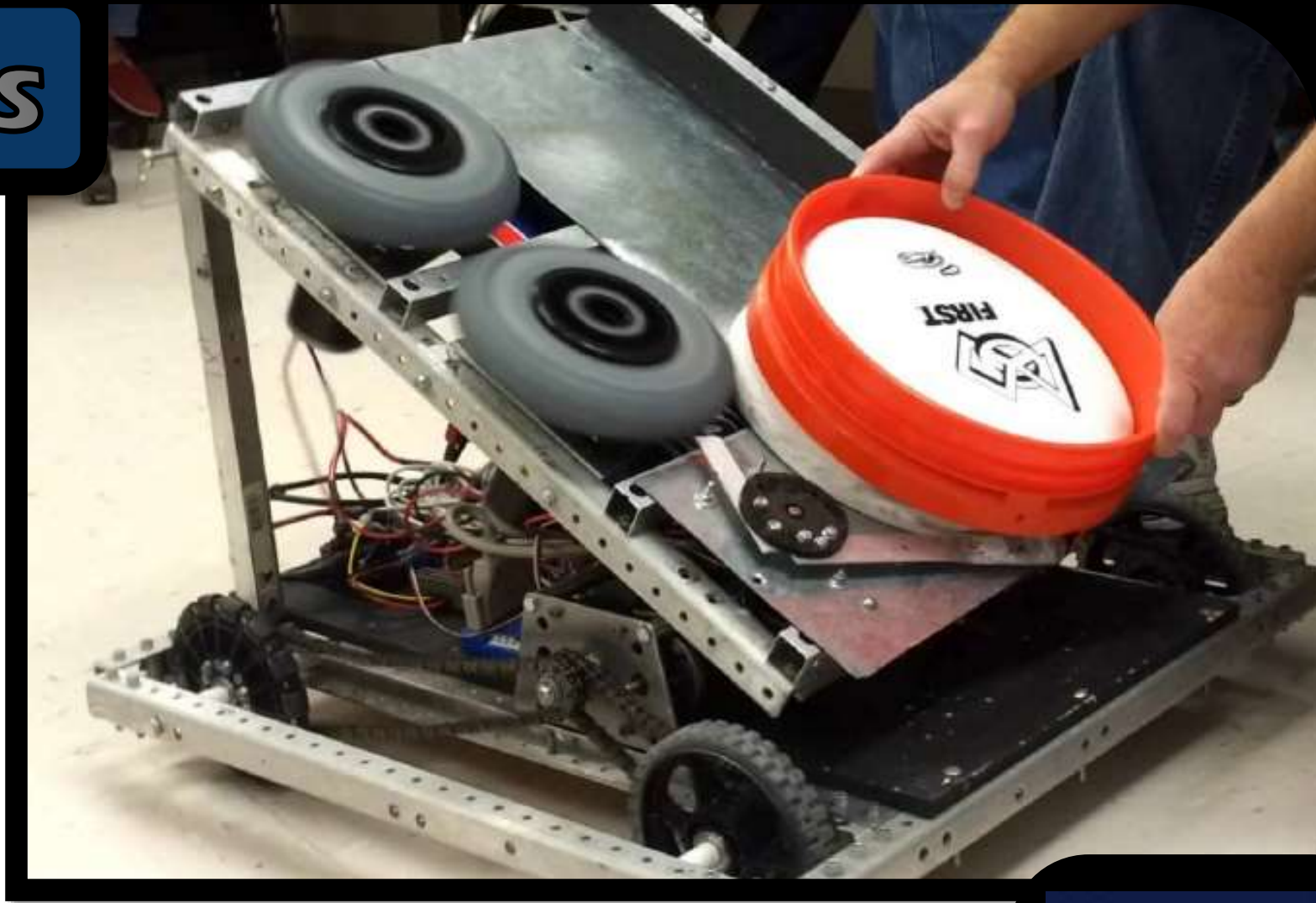

# Manipulators

## Linear Path

Some games with odd game pieces make storing them in the robot in a linear path, from intake to scoring, a sane proposition. This isn't seen frequently but is normally reserved for non-spherical game pieces.

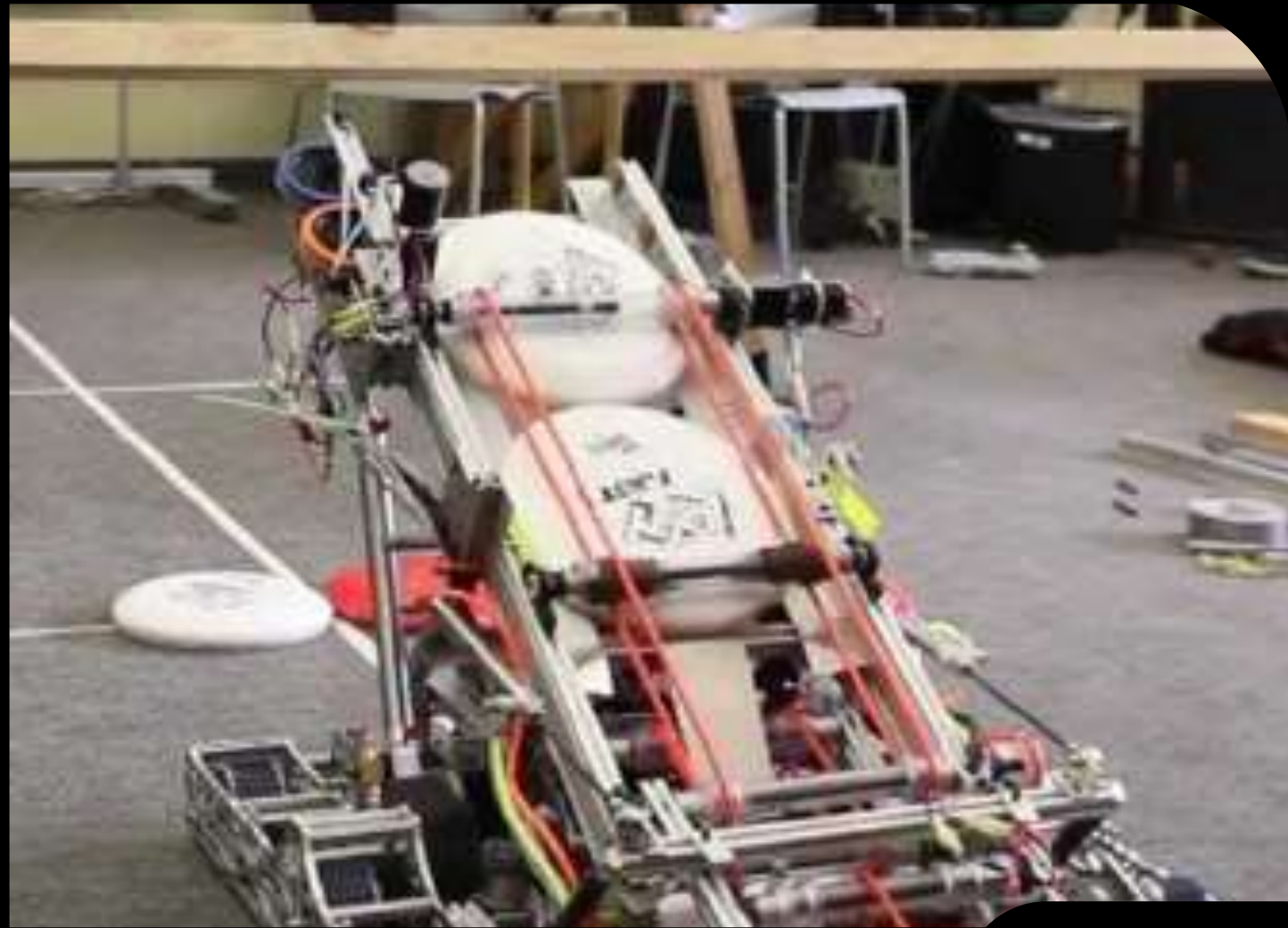

# How Not to Robot:

## Team 5256's 2017 Shooter Hopper

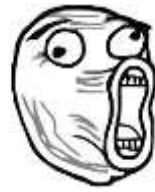

Balls can weigh down roof and reduce size of opening, stopping flow to shooter.

This area is still prone to jamming at or near where balls are funneled into the shooter lane

Agitator motor torque is good but too slow to keep up with shooter. Does not prevent or clear some jams.

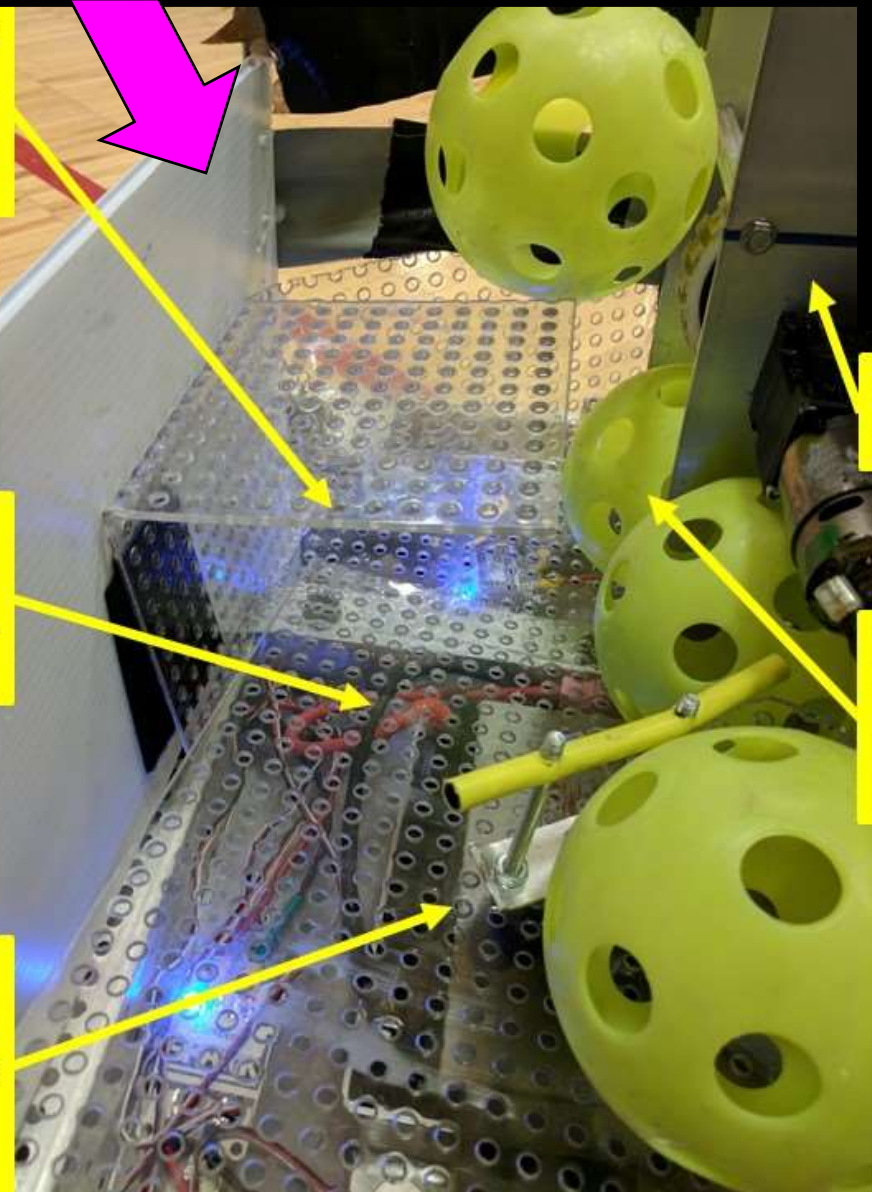

No matter how you're moving game pieces, if you have more than one, you typically need them to remain owned and in control the whole path of traversal. For that reason, serialization, single-file lines makes sense for game pieces, especially ones fed into shooters. Otherwise, jamming is a frequent problem faced by teams.

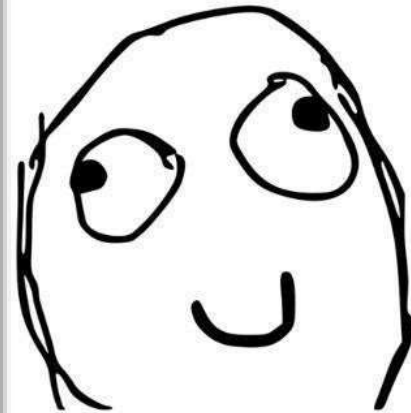

Shooter accuracy could benefit from adding weight to flywheel hexshaft.

Contact with flywheel is poor where feed lane meets the shooter. surface sitting as much as an 1/8<sup>th</sup> inch below that of the shooter where the two meet.



# Section 6: Manipulators

## Skills

-  Be able to explain the mechanical principles behind roller claw operation.
-  Understand the differences between single and double wheel shooters.
-  Know the various styles of hoppers and the role of serialization in some designs.

## Review Questions

1. What is the the difference between a Roller Claw and an Articulated Roller Claw?
2. How fast should an Intake Roller spin in relation to the speed of it's robot?
3. What is one of the biggest issues with hoppers that routinely requires extensive problem solving?

## Section 6

# Pneumatics

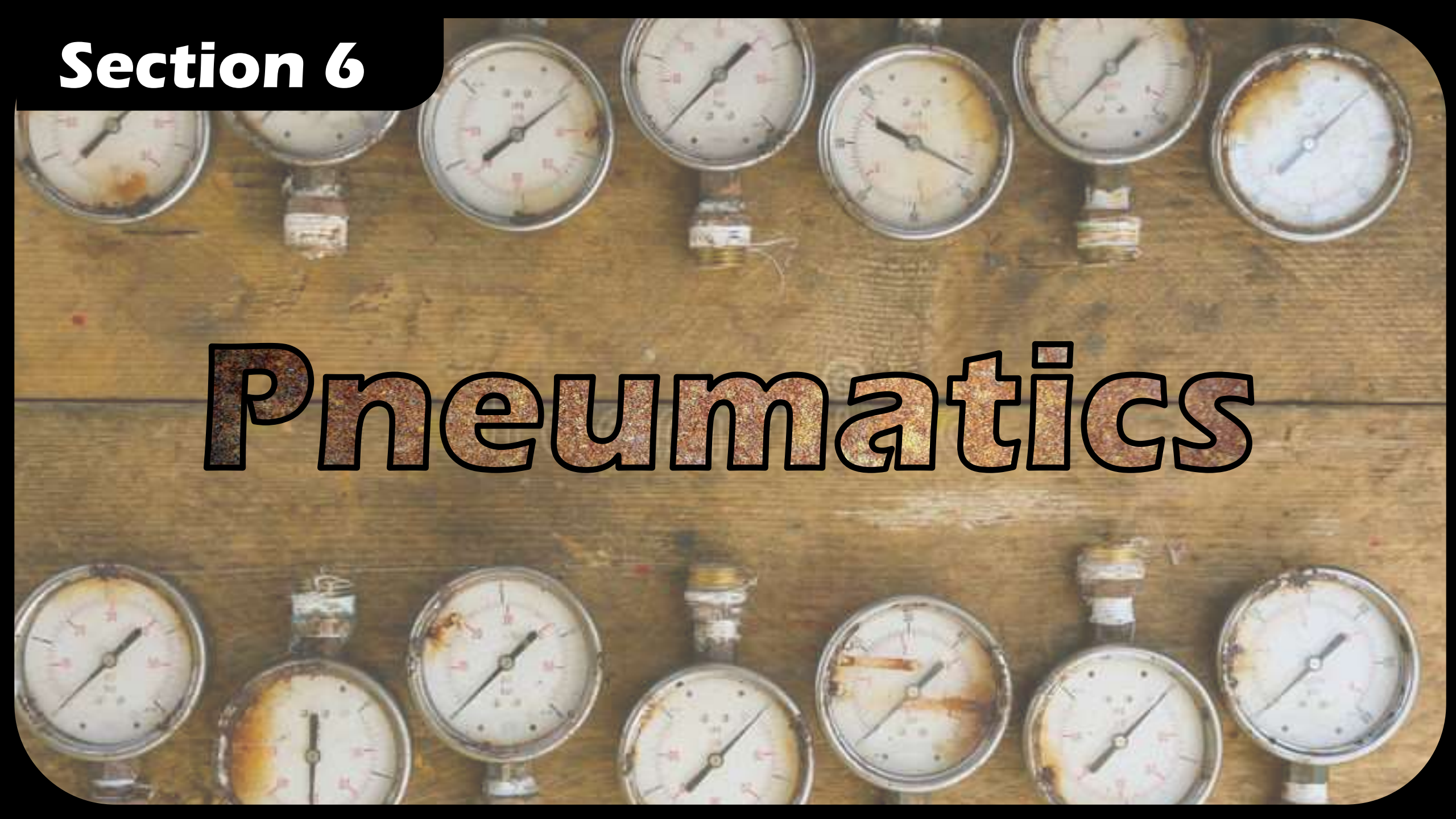

# Pneumatics

## Component Overview

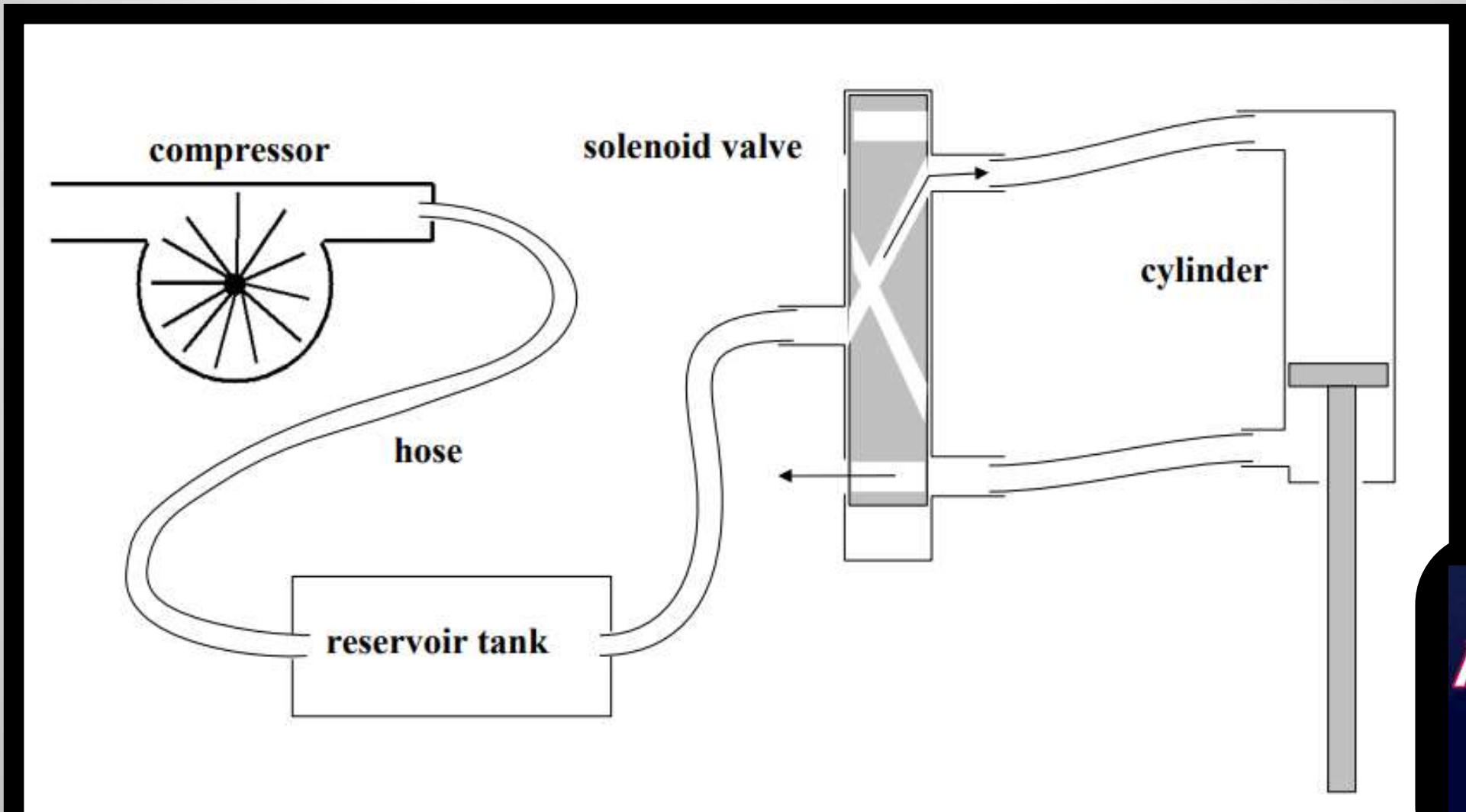

# Pneumatics

## Air Compressor (1.1 cfm MAX)

Light-duty compressors meant to fill no larger than a 1.0 gallon air tank\*.

- Connects to air tank and pressure gauge
- Compresses air to be used by pistons
- Susceptible to overheating from excessive use.

[\\*Per VIAIR website](#)

AndyMark 1.1 Pump



VIAIR 90c Compressor

**ATOMICS**  
5256



# Pneumatics

## Air Tank

Air accumulator with push to connect fittings.

- Holds compressed air (125psig)
- Can be chained together to hold more air



Clippard Air Tank, 574 ml

# Pneumatics

## Cylinder

Produce linear motion using compressed air.

- Fixed length
- Can only extend or retract (2 positions)



Cylinder, Air, SMC, 2" Stroke



PHD 4x4, 3/4" Bore, 4" Stroke

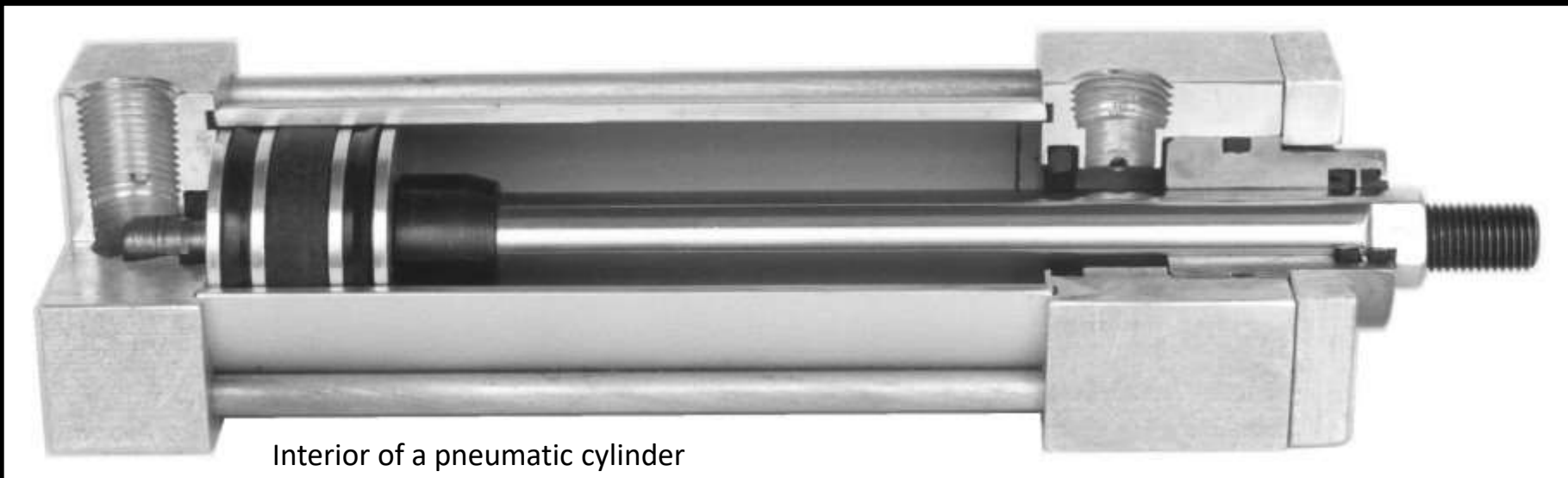

Interior of a pneumatic cylinder

# Pneumatics

## Solenoid Valve

Electromechanically operated valve supplying air to cylinders.

- Receives signal from Pneumatic Control Module (PCM) to extend or retract piston.
- Can manually extend and retract piston.
- Most are “air piloted” which means that air does the main switching, requiring a minimum level of air pressure to operate (usually 30 psi)



Double Solenoid Valve, Mead, 1/8 NPT

# Pneumatics

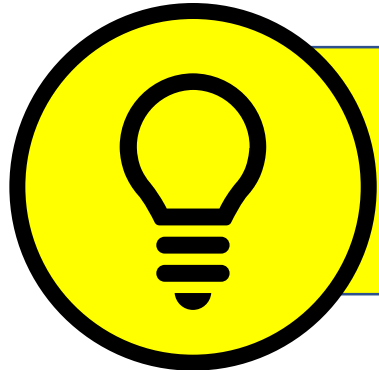

## On-Board Setup

All pneumatics components, including air compressor, are installed on robot.

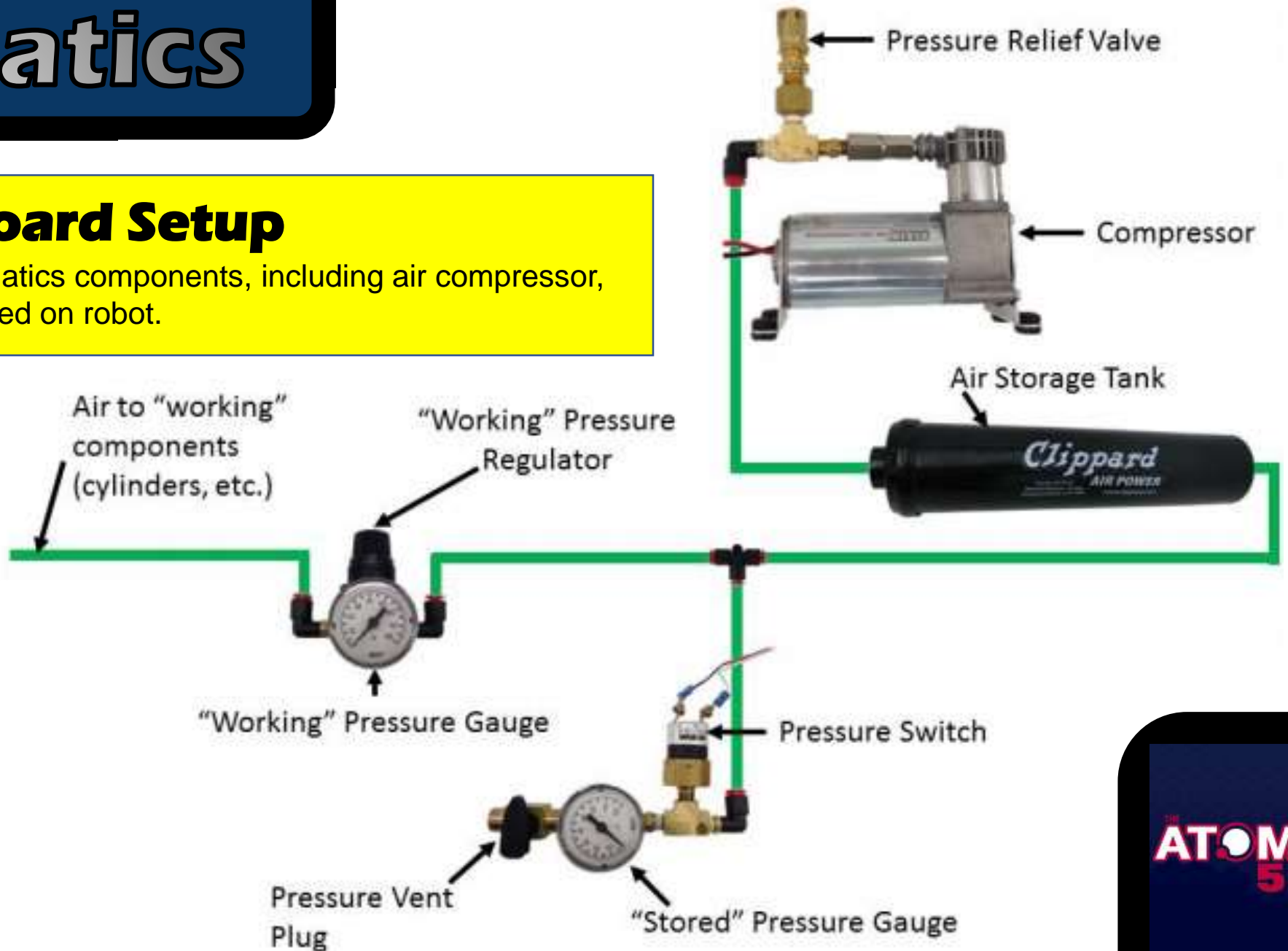

# Pneumatics



## Off-Board Setup

Air compressor is not installed on robot.  
Air accumulator tanks must be filled in the pit using an FRC legal air compressor.

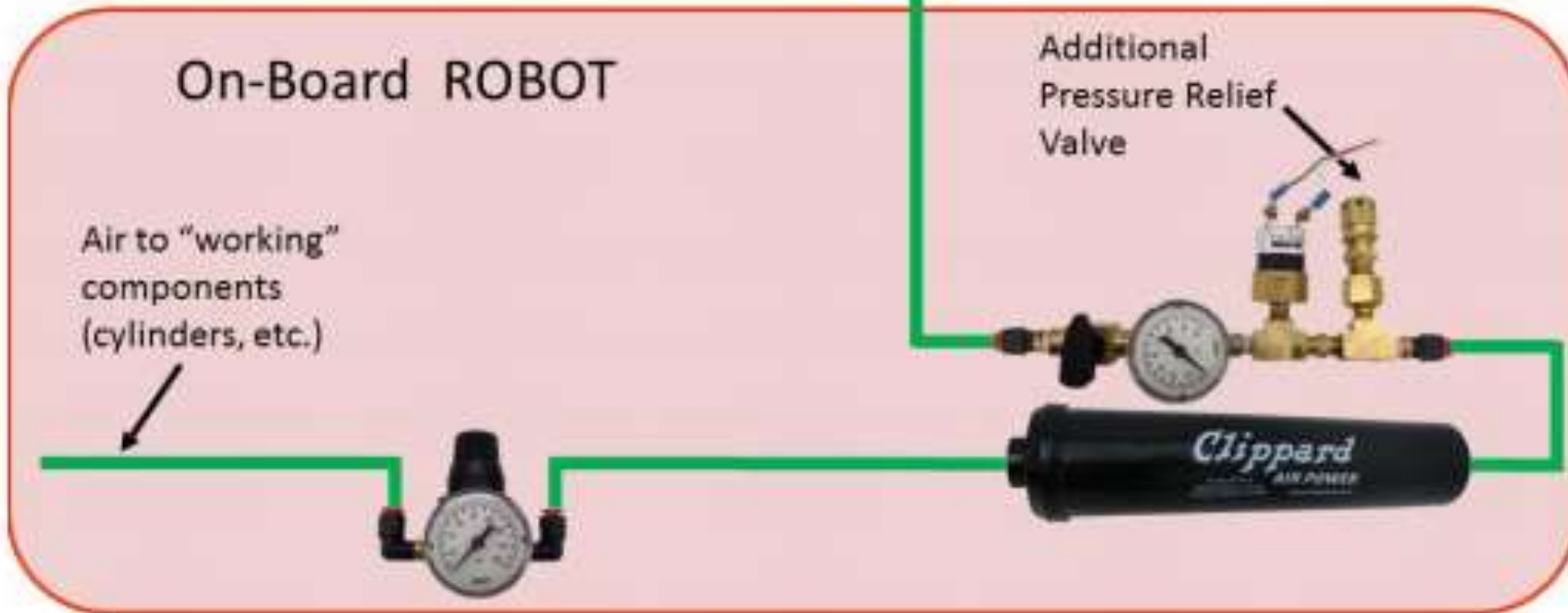

# Pneumatics

## Pros

- Much lighter than motors when several are used.
- Can maintain position at stall without failure.
- Can be used in more compact environments.
- Actuation can be very fast.
- Typically rugged and resistant to impacts.
- Easy to setup and install.
- Superior means of producing linear motion.

## Cons

- Heavy “upfront cost” in terms of weight/space.
- Excessive air requirement may lead to a higher compressor drain on battery.
- Compressor Duty Cycle.
- Vibration in system.
- Possible to run out of air depending on system design and usage.
- Overheating with prolonged use.

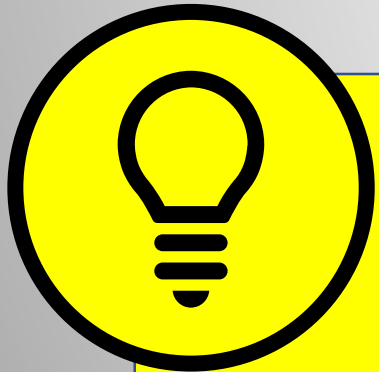



## **Making the Most of Pneumatics**

Pneumatics can provide a very efficient and robust means of actuation in your robot if used effectively in a way that offsets the weight and bulk of the system, not to mention the additional demands on the battery.

Basically, make the most of your pneumatic system—If you got ‘em, use ‘em.

# Section 7: Pneumatics

## Skills

-  Draw a simple diagram of a pneumatic system.
-  Be able to correctly connect fittings and hoses.
-  Design a simple assembly with pneumatic actuation.

## Review Questions

1. What purpose of an accumulator tank?
2. What is the basic function of a solenoid and how does it work?
3. What is the difference between an onboard and offboard setup?

## Section 8

# Motors



# Motors

All DC Motors fall into one of the following two categories:



Brushed  
DC Motor



Brushless  
DC Motor

# Brushed DC Motors

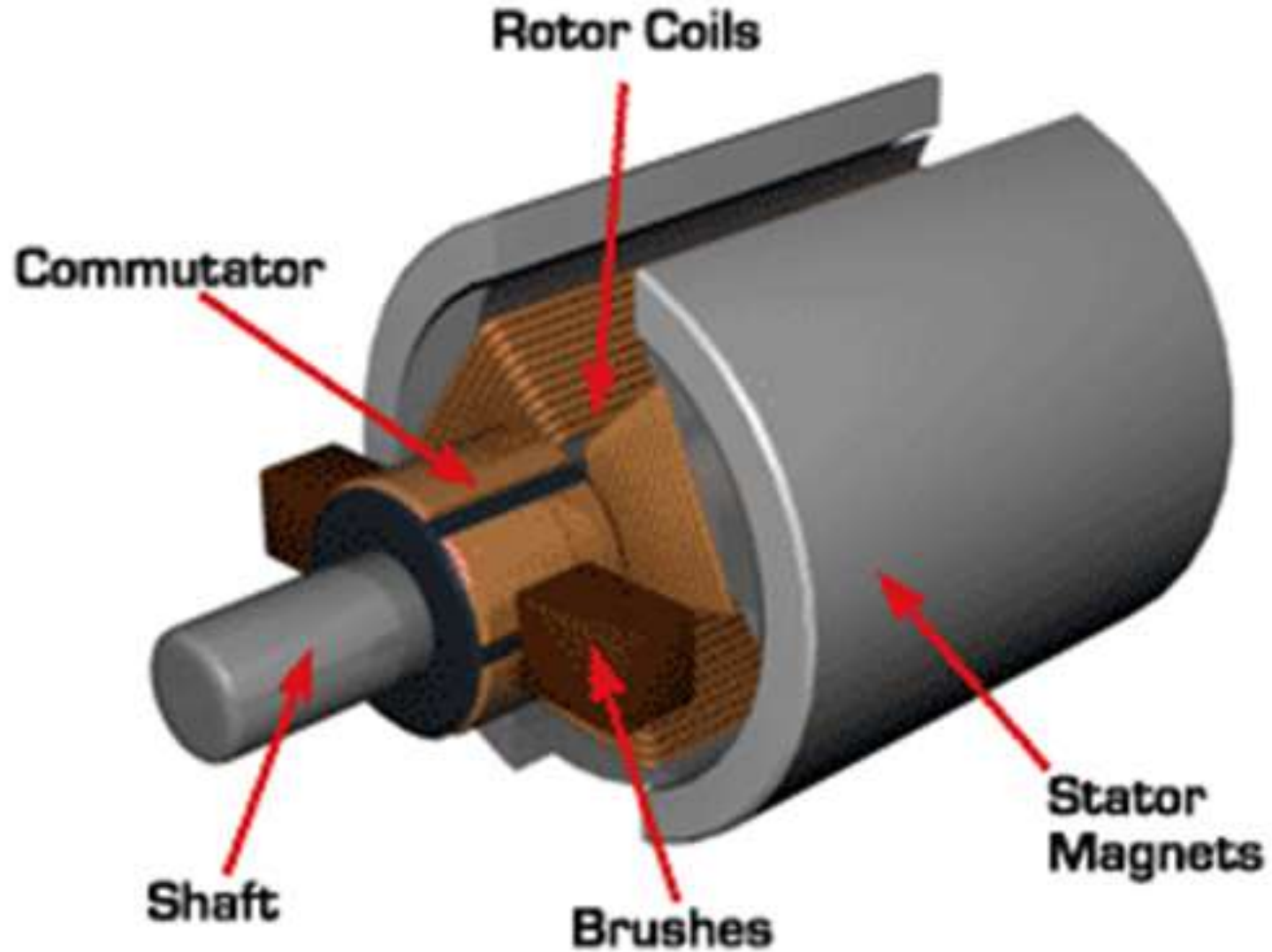



## Brushed DC Motors

### How do they work?

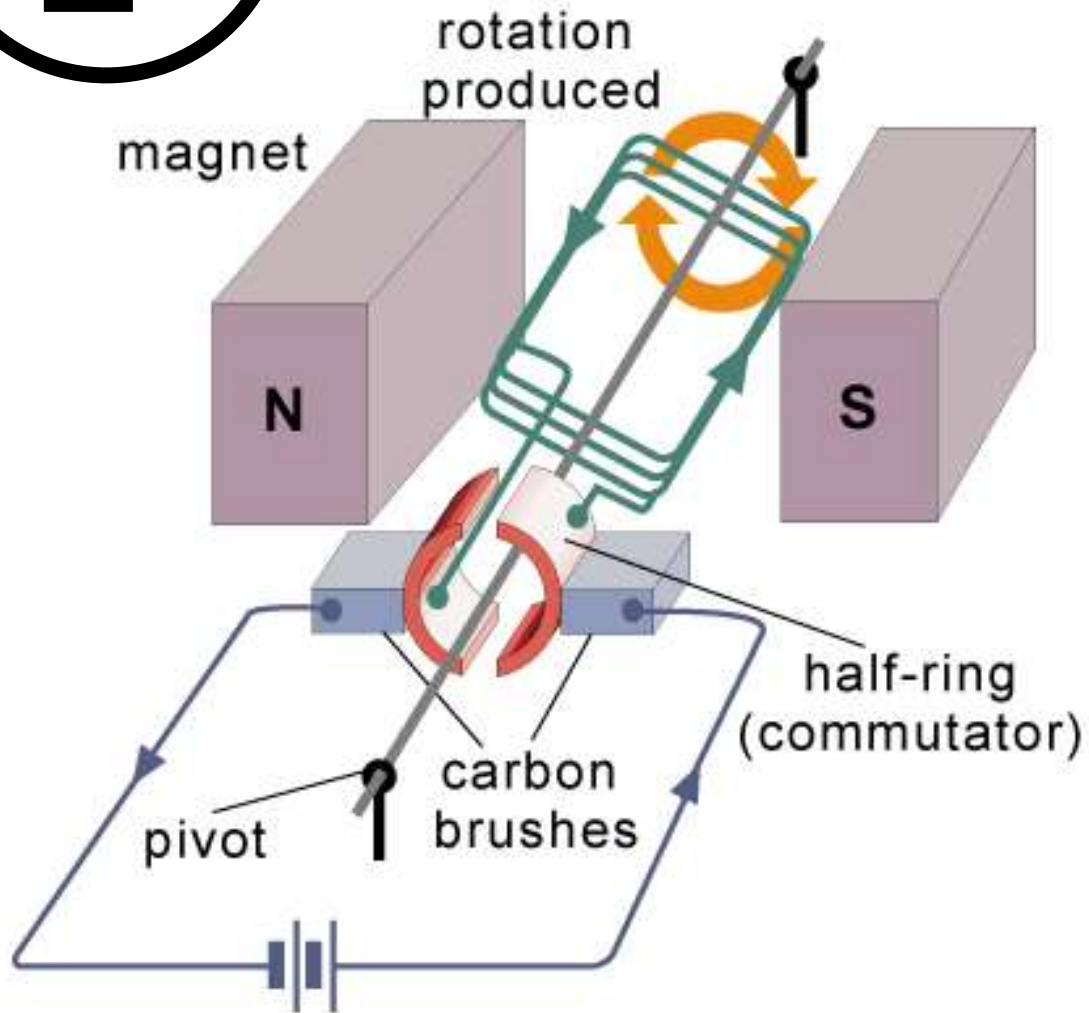

A brushed DC motor has two stationary permanent magnets on the outside and a spinning shaft on the inside. Mounted on the shaft is an electromagnet connected to the separated halves of two split ring electrodes.

Power is applied to two carbon brushes, which contact the electrodes. This energizes the electromagnet, causing it to repel the permanent magnet, making the shaft rotate. As the electrodes rotate, contact is made and broken with the brushes, reversing the polarity of the electromagnet at each turn and maintaining motion.

Brushed DC Motors are cheap and easy to manufacture but have some definite disadvantages:

- ⚡ Because the brushes constantly make and break connections, there is sparking and electrical noise.
- ⚡ The brushes will eventually wear out.
- ⚡ Brushes limit max motor speed.
- ⚡ Having the electromagnet in the center of the motor makes it harder to cool.

# Motors

## Standard Brushed DC (CIM, Mini-Cim, Bag, 775 Redline, 775pro)

Most commonly found in drivetrains  
and mechanisms.

### Pros:

Varies by model, but generally robust,  
simple 2-wire operation, low-cost.

### Cons:

Varies by model; Low torque, Weight,  
Heat issues, Brush wear, Rules require  
one ESC capable of 100W+ per motor .



775 Redline



CIM Motor







MiniCIM Motor



Bag Motor

	Motor	Size	Weight	No Load RPM	Max. Power	Stall Torque	Stall Current
	<b>CIM</b>	2.5in dia. X 4.34in	2.82 lbs	5,310 (+/- 10%)	337W	2.42 N-m	133A
	<b>Mini-CIM</b>	2.5in dia. X 3.36in	2.16 lbs	5,840 rpm (+/- 10%)	215W	1.4 N-m	89A
	<b>775Pro/ 775 Redline</b>	1.744in dia. X 4.34in	0.8 lbs	18,730 (+/- 10%)	347W	0.71 N-m	134A
	<b>Bag</b>	1.59in dia. X 2.602in	0.71 lbs	13,180 (+/- 10%)	149W	0.4 N-m	53A
	<b>RS-775- 15</b>	1.41in dia. X 3.19in	0.78 lbs	5700 (+/- 10%)	---	0.428 N-m	---

# Stuff you should know about these common FRC motors

	<b>CIM</b>	Big and heavy workhorse used in most drivetrains and many mechanisms. Reliable and able to handle heat and stalling well. Did I mention they are heavy?
	<b>Mini-CIM</b>	A little smaller and lighter than a regular CIM and slightly faster too, but with a fairly significant drop in power and torque. Still, some teams swear they are way faster.
	<b>775Pro/ 775 Redline</b>	Crazy fast feather-light fan-cooled motor with a wattage rating equal to or greater than a CIM. Low torque by comparison. Will let out magic smoke if stalled for more than a few seconds. Slowly becoming mainstreamed for powering drivetrains before the release of the Rev Neo BLDC.
	<b>Bag</b>	About a third slower than a 775Pro with a lower wattage rating, but with higher torque and greater tolerance for stalling. The middle child of the CIM family who gets little respect despite actually being pretty okay.
	<b>RS-775-15</b>	Preinstalled on the AndyMark PG series gearmotors, which is probably the only reason they ever get used.

# Motors

## Brushed DC Gearmotors (Automotive, throttle, AM PG series)

Motors with preinstalled gearboxes for large gear reductions; Many repurposed and included with the KOP.

### Pros:

Higher torques; Can wire two motors to one ESC; Some resistant to backdriving.

### Cons:

PG series models very heavy, Non-standard output shafts on auto/throttle motors, tend to be very slow.



NeveRest 60



Snowblower Motor



Window Motor



AndyMark PG-71 Gearmotor



## Inside a Worm Drive

Some KOP gearmotors, such as the window and snowblower motors, feature a worm drive like the example at right.

In this gear arrangement, a motor-driven, screw-like worm meshes with a worm gear, often resulting in a large gear reduction with the following properties:

- ⚙ Significant reduction in speed
- ⚙ Increased torque
- ⚙ 90 degree transfer of motion
- ⚙ Compact gearbox size
- ⚙ Resistance to backdriving

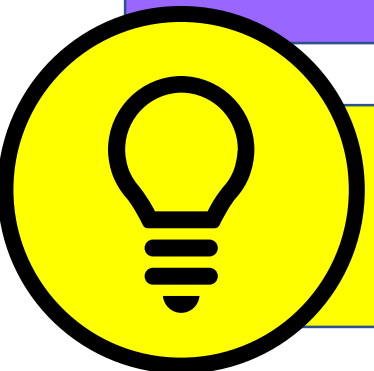

**ProTip:** Forces applied to the output of a worm drive generally cannot backdrive the motor due to the high degree of friction involved between the worm and worm gear.

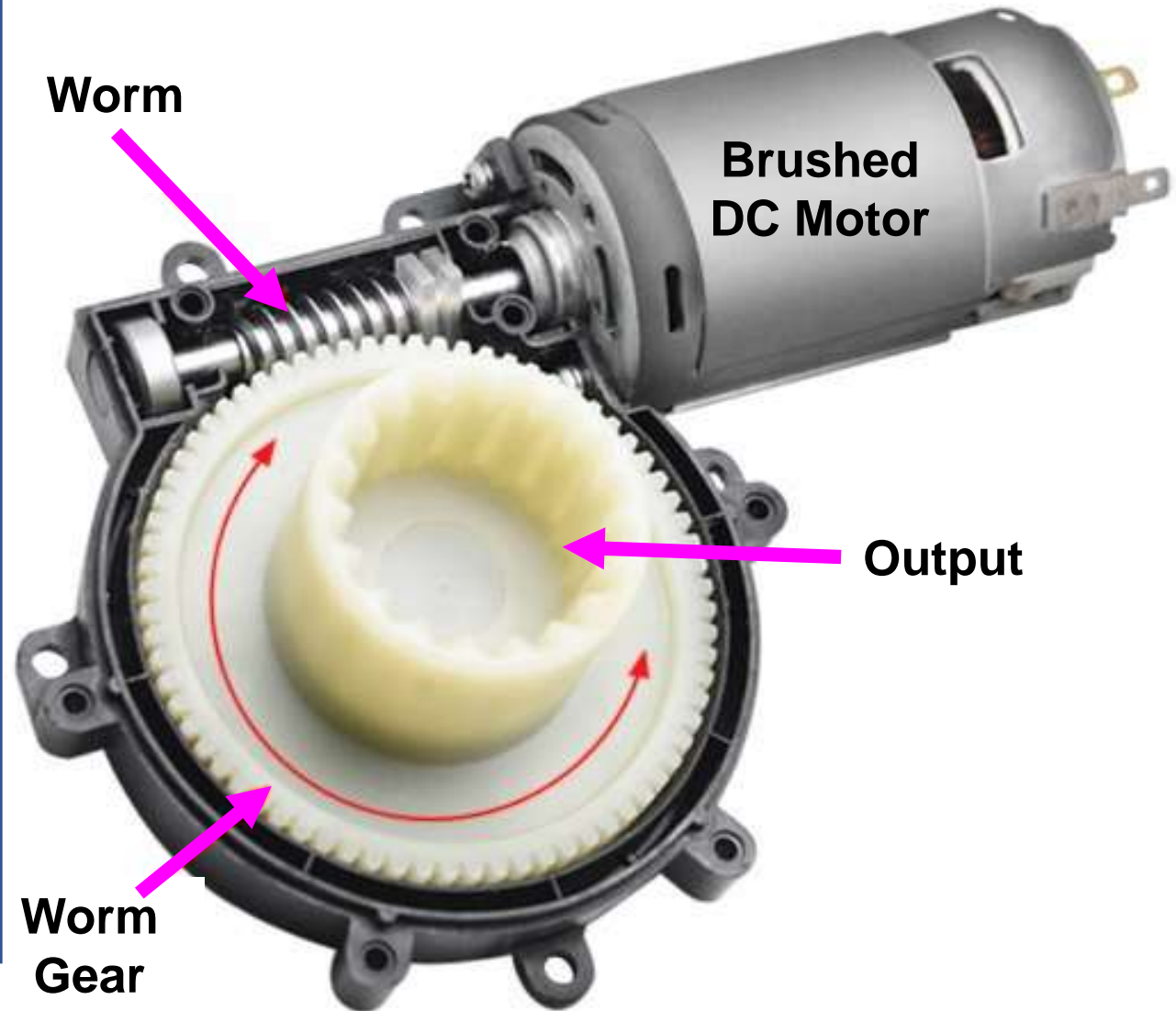



# Motors

## Servos

(DC Hobby Servo)

PWM controlled motor with integrated gearbox for light duty actuation (opening a shutter, flipping a switch, shifting gears).

### Pros:

Good rotation control, Good torque for size/weight, connects directly to RoboRio.

### Cons:

Most limited to 180° rotation, plastic gears can break/wear out if overloaded.

Hi-Tec HS-311 Servo





## Hobby Servos

A typical servo consists of a small electric motor driving a train of reduction gears. A small potentiometer, a type of variable resistor commonly used for volume knobs in audio equipment, is connected to the output shaft.

In the example at right, a small brushed DC motor drives a gear train designed to reduce speed and increase torque. On the opposite end of the motor a small belt connects to a potentiometer, causing them to move together in sync.

This allows the position of the motor to be monitored and controlled with a good degree of ease and accuracy using a series of electric pulse signals called pulse width modulation (PWM).

We'll cover PWM later, but for now think of it like Morse code using signal level voltage.

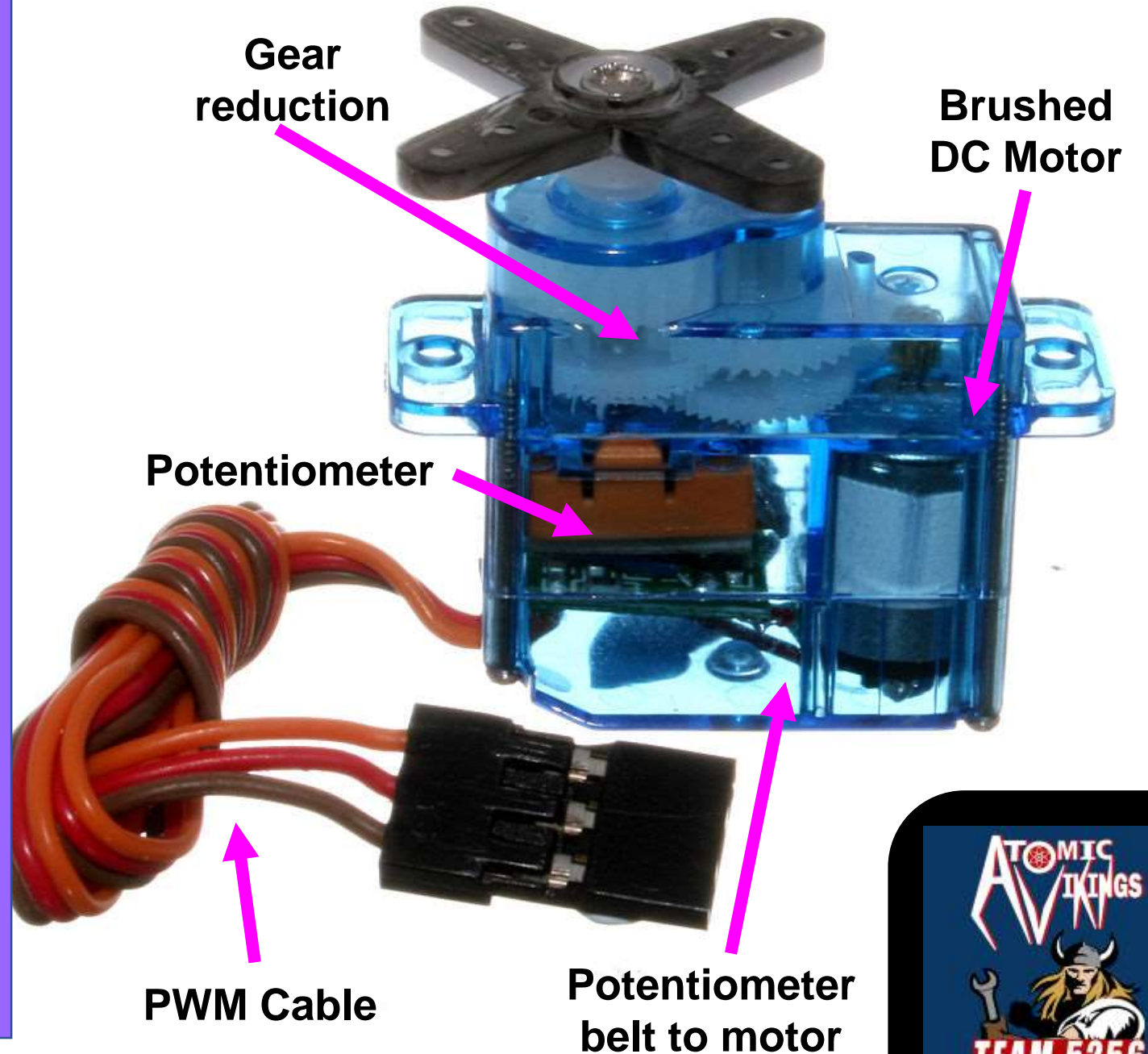

# Brushless DC Motors

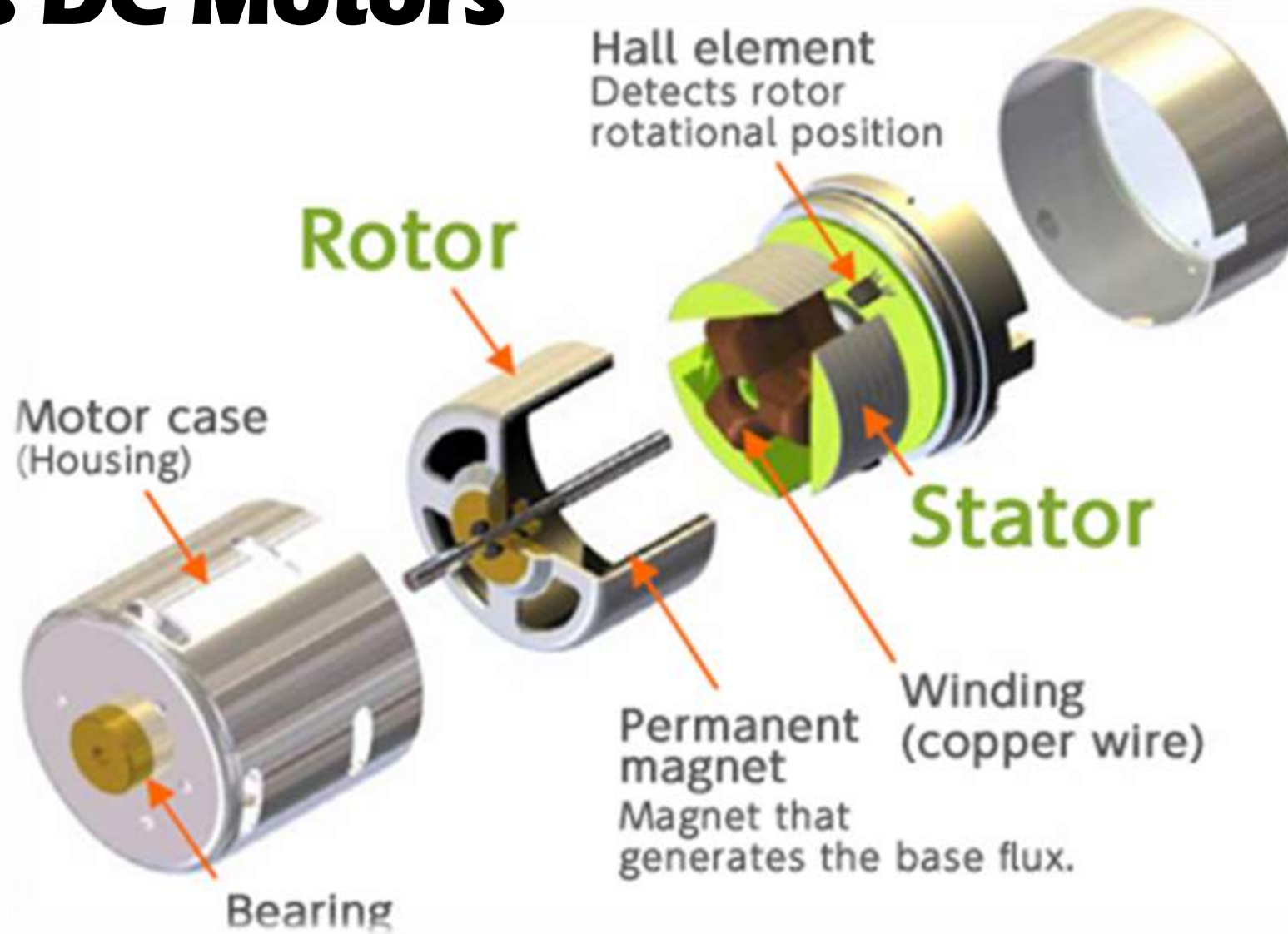

Less than 100 teams used the single FRC-legal BLDC Motor released for the 2018 season. However, early reactions to the 2019 REV Neo



## Brushless DC Motors

### How do they work?

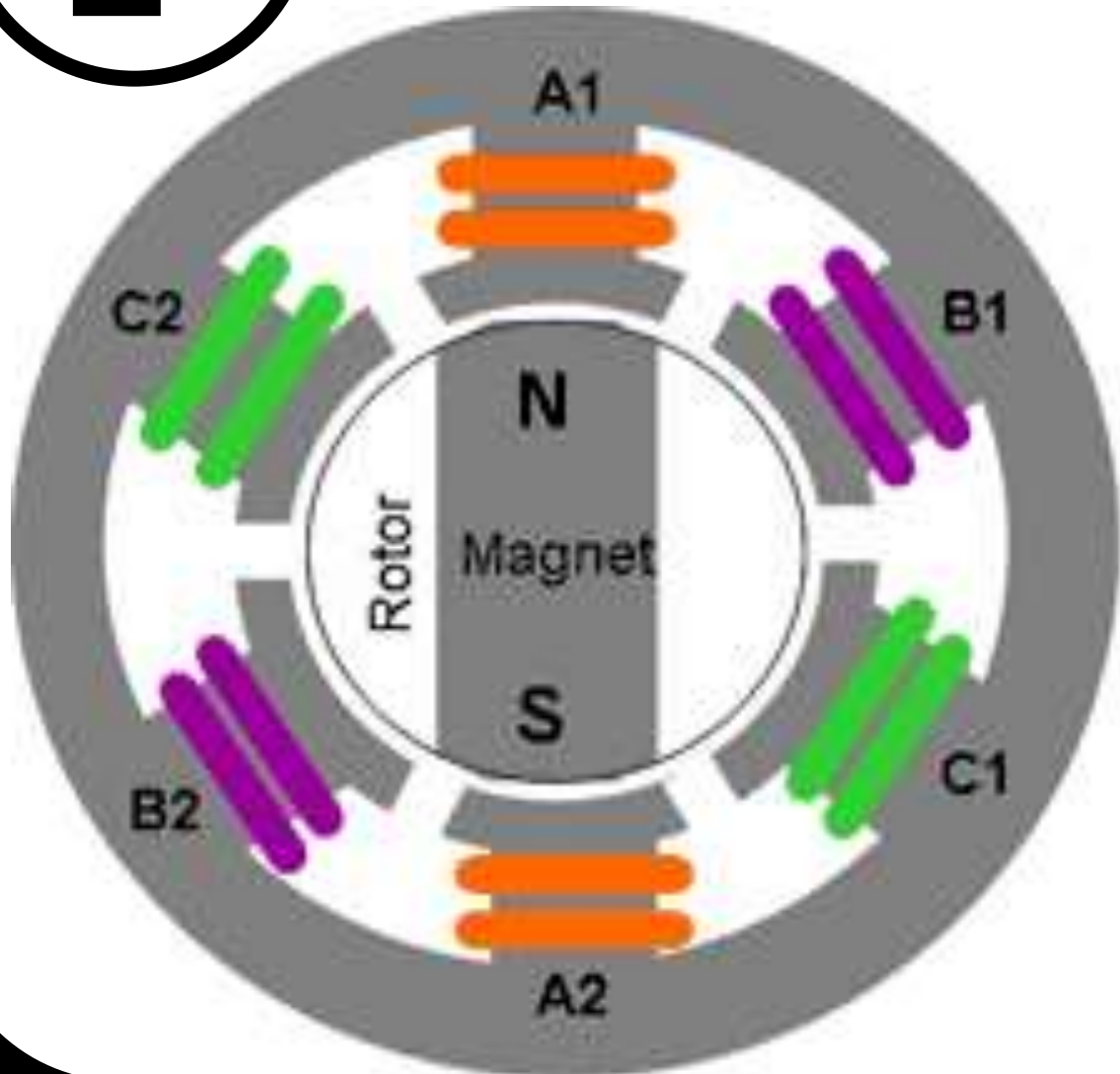

In a brushless DC motor (BLDC) the permanent magnets have been relocated to the spinning shaft where they are surrounded stationary electromagnets. Using onboard computer control, power is supplied to the electromagnets in sequence, causing the shaft to spin while magnetic sensors track it's position, allowing for more precise control.

Advantages of BLDCs include:

- ⚡ No sparking and much less electrical noise.
- ⚡ Easier to cool with electromagnets on the stator.
- ⚡ Greater precision and speed control making BLDCs more efficient than brushed DC motors.
- ⚡ No brushes to wear out.
- ⚡ On-board motor controller

The disadvantage is increased cost compared to brushed DC motors. However, this is recoverable due to the greater efficiency, longer lifespan, and integrated motor control of BLDCs.

# Motors

## Brushless DC Motor (Nidec Dynamo BLDC )

First ever FRC-legal BLDC offers mediocre performance at a high price tag, but, hey, it's got a an integrated ESC.

### Pros:

Integrated ESC, No brush wear/arcng. Your Robot Inspector will probably be surprised to see one of these in the wild.

### Cons:

Expensive, Low-powered.



Nidec Dynamo BLDC

# Motors

## Brushless DC Motor (REV Neo Brushless Motor)

A drop-in CIM replacement that's compact and lightweight with an integrated encoder.

### Pros:

Efficient, lightweight, small and powerful.  
Integrated hall effect and temperature sensors.

### Cons:

Only works with Spark Max motor controllers.



# Section 8: Motors

## Skills



Develop a knowledge of the capabilities and uses of each of the following FRC-legal motors: CIM, Mini-CIM, Bag motor, 775pro.



Know why fan-cooling vs. thermal mass are important when concerning brushed DC motors.



Understand why BLDC motors are so different from brushed DC motors.

## Review Questions

1. Which motor has a higher tolerance for prolonged stalling: CIM or 775pro?
2. How many CIM motors can be wired to a single ESC?
3. How many different types of BLDC motors are legal for FRC use?

## **Section 9**

# **Gears and Gearboxes**



# Gearboxes

## Major Gear Types



Spur Gears



Gear Rack



Bevel Gears



Internal Gear



Worm Drive



**Spur gears** are the most common type of gears. They have straight teeth, and are mounted on parallel shafts. Drivetrain gearboxes typically use many spur gears at once to create large gear reductions.



**Rack and pinion gears** are used to convert rotation into linear motion. A perfect example of this is the steering system on many cars. The steering wheel rotates a gear which engages the rack, sliding it right or left, depending on which way you turn the wheel.



**Bevel gears** are useful when the direction of a shaft's rotation needs to be changed. They are usually mounted on shafts that are 90 degrees apart, but can be designed to work at other angles as well.

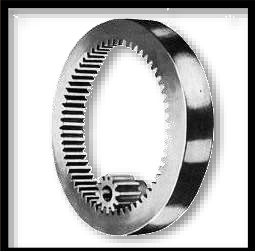

**Internal gears** have teeth cut on the inside of cylinders or cones and are paired with external gears. The main use of internal gears are for planetary gear drives.



**Worm drives** are used when large gear reductions are needed. They have an interesting property that no other gear set has: the worm can easily turn the gear, but the gear cannot turn the worm. This is because the angle on the worm is so shallow that when the gear tries to spin it, the friction between the gear and the worm holds the worm in place.

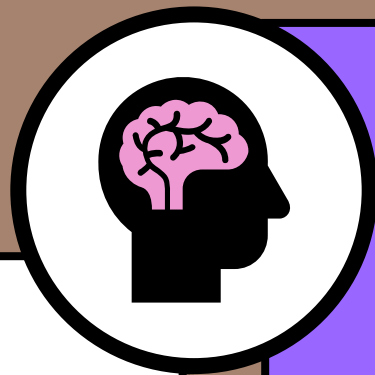

# Gears: What You Need to Know

This stuff can get really complicated—and there's a lot more to learn—but the following should be the most important takeaways from this section:

## ⚙️ **Tooth Count**

- The number of teeth on a given gear.
- Gear ratio is determined by the Tooth Count of one gear compared to another.

## ⚙️ **Diametral Pitch (DP)**

- The number of teeth of a gear per inch of its pitch diameter.
- Commonly used for sizing gears. The DP of all gears in a set should match.

## ⚙️ **Bore**

- The size shaft for which the gear is designed to mount.

If you know the tooth count, DP and bore of a gear, you have the basic information needed for most basic applications in FRC.



# Gearboxes

## Single Speed

(AM Toughbox Mini, Vex WCP-SS)

Single speed drivetrains; Least costly and simplest option.

### Pros:

Lowest cost option for drivetrains;  
Customization of overall gear ratio;  
Replaceable parts.

### Cons:

Only one overall gear ratio.

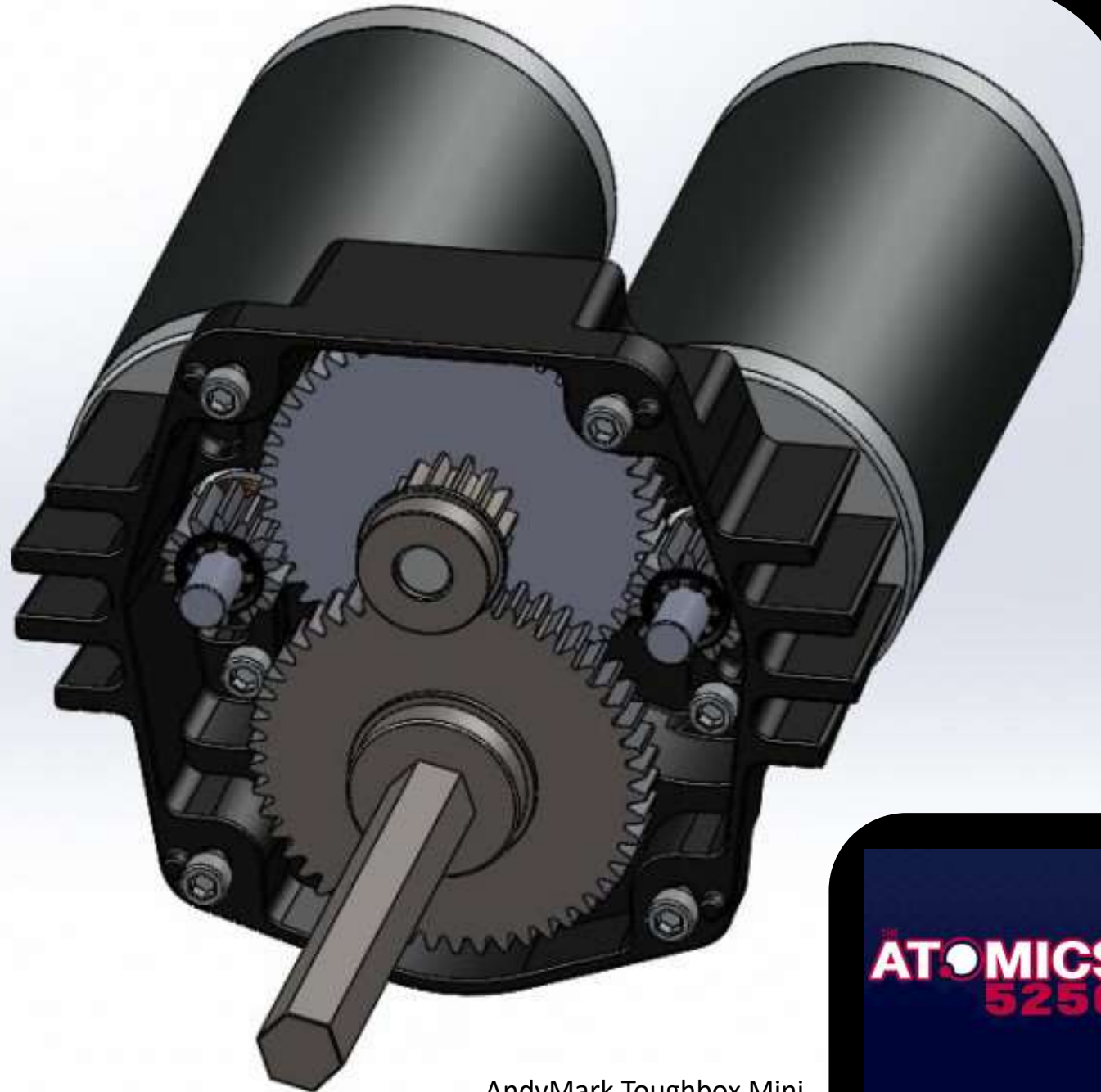

AndyMark Toughbox Mini

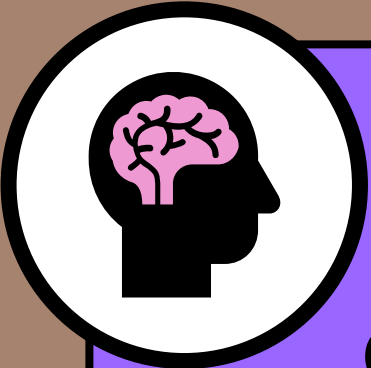

# Gear Ratio Calculation

## Stage 1

A = 14T CIM pinion gear  
B = 50T Large Cluster Gear

## Stage 2

C = 16T Small Cluster Gear  
D = 48T Large Output Gear

$$(B/A) \times (D/C)$$

$$(50/14) \times (48/16)$$
$$3.57 \times 3 = 10.71$$

Overall Gear Ratio = 10.71:1

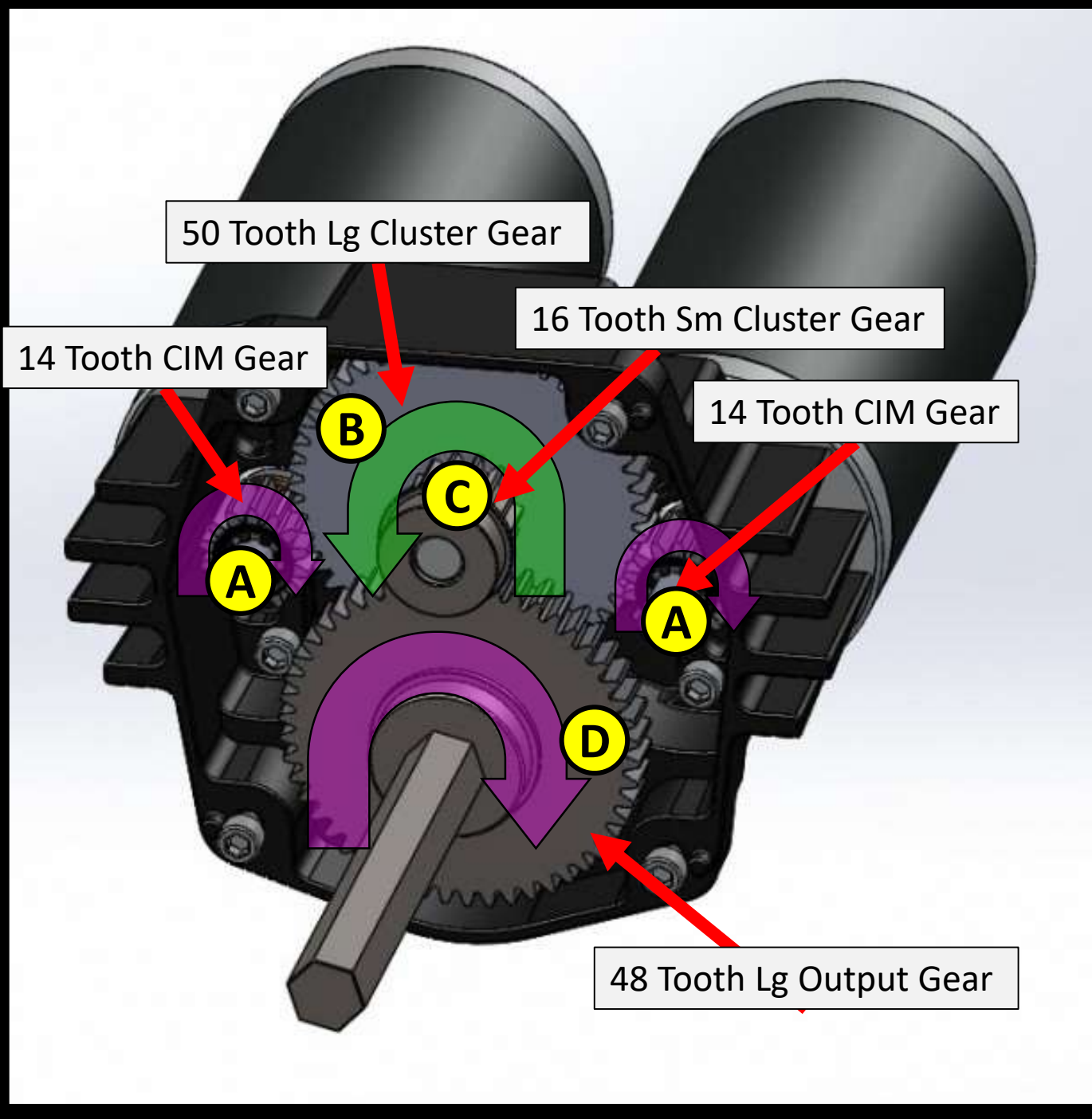



# JVN's Mechanical Design Calculator

A spreadsheet designed to simplify the process of designing effective gear trains.

1. Enter motor info
2. Enter wheel dia, CoF & weight
3. Select from gearing options

WCP SS Gearbox Drivetrain					
4	Choose Gearbox Motors:	Free Speed (RPM)	Stall Torque (N*m)	Stall Current (Amp)	Free Current (Amp)
5	2 CIM	5330	4.82	262	5.4
7	Wheel Dia. (in)	Wheel Coeff of Friction	Total Robot Weight (lbs)	Weight on Driven Wheels	
8	6	1.1	140	100%	
Select VEXpro Gearbox Options:					
13	Choose Motor Pinions:	11-tooth Pinion [50:11]			
14	Choose 2nd Stage Gearing:	2nd Stage Option 5 [60:14]			
	Additional External Reduction:	Driving Gear	Driven Gear		
		1	1		
Drivetrain Outputs:					
19	Drivetrain Free-Speed	Drivetrain "Real Life" Speed	"Pushing" Current Draw per Gearbox	Overall Ratio	
20	7.16 ft/s	5.80 ft/s	84.65 Amps	19.48 : 1	
Chosen Gearing Config:					
23		Driving Gear	Driven Gear		
24	Initial Gearing Stage:	11	50		
25	2nd Gearbox Stage:	14	60		
26	External Stage:	1	1		

<http://www.vexrobotics.com/vexpro/motion/gearboxes/wcp-ss.html>

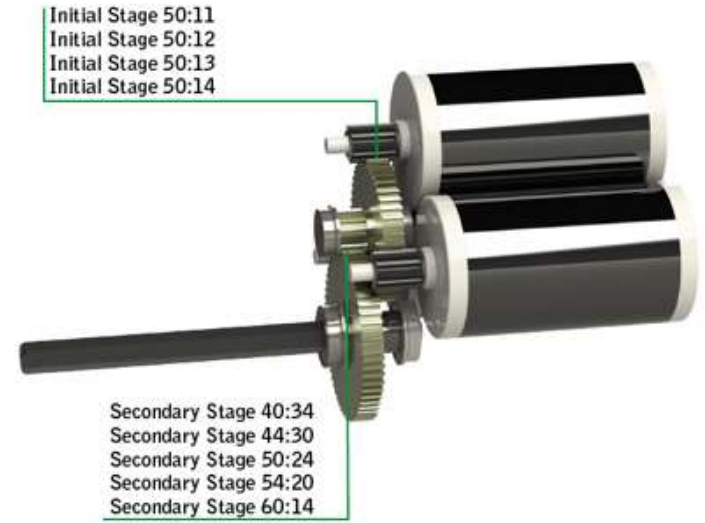

Calculator will determine Free Speed, "Real Life" speed, "Pushing" current draw & overall gear ratio

Drivetrain

<http://www.vexrobotics.com/vexpro/motion/gearboxes/wcp-ss.html>

Free Speed (RPM)	5330
2 CIM	

Wheel Dia. (in)
6

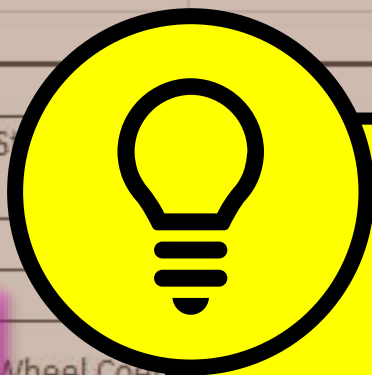

## Pro Tip: Don't forget that other factors come into play!

These are just a few things affecting overall gear ratios:

- 🧠 Wheel Diameter
- 🧠 Sprocket sizes
- 🧠 Winch Diameter
- 🧠 Spooling of cable/rope (size increasing while winding)

Keep this in mind when determining your gearing.

Gearbox Options:

Motor Pinions:	11-tooth
Stage Gearing:	2nd Stage

Driving Gear	Driven Gear
1	1

Outputs:

Drivetrain Free-Speed	Drivetrain "Real Life" Speed	"Pushing" Current Draw per Gearbox	Overall Ratio
7.16 ft/s	5.80 ft/s	84.65 Amps	19.48 : 1

Config:

# Gearboxes

## Two Speed

(AM Evo Shifter, Vex WCP-DS)

Shifting from fast speeds to lower gear ratios with more torque; PTO models can run mechanisms.

### Pros:

Capability to shift to a different overall gear ratio; Customization; Replaceable parts; Some have PTOs.

### Cons:

Significant cost; Complexity; Shifters can fail due to wear or pneumatic/mechanical issues.

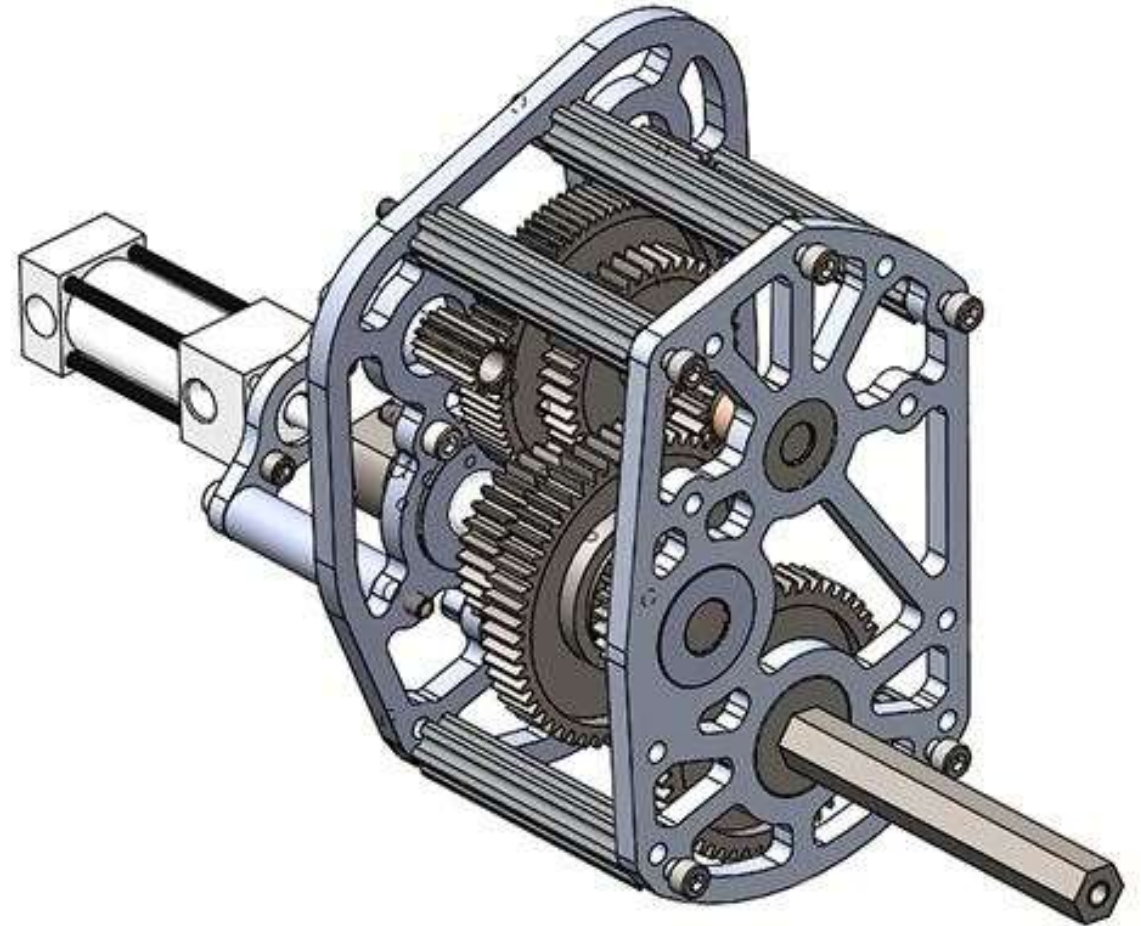

AndyMark Evo Shifter



# Gearboxes

## Planetary

(CIM Sport, BaneBots BB220)

Mechanisms requiring a lot of torque for high loads.

### Pros:

Powerful, compact, durable; Parts replaceable.

### Cons:

Can be bulky/heavy, expensive, not modular.



BaneBots BB200 Planetary Gearbox





# Planetary Gearing

A planetary gear train consists of two gears mounted so that the center of one (planet) gear revolves around the center of the other (sun) gear.

The planet and sun gears mesh so that their pitch circles roll without slip. The sun gear is fixed and the planetary gear roll around the sun gear.

The main reasons to use this gear type is for it's high torque, compound design, and ability to align it's input and output along a shared central axis. The latter is why planetary gearing is commonly found in most cordless drills.

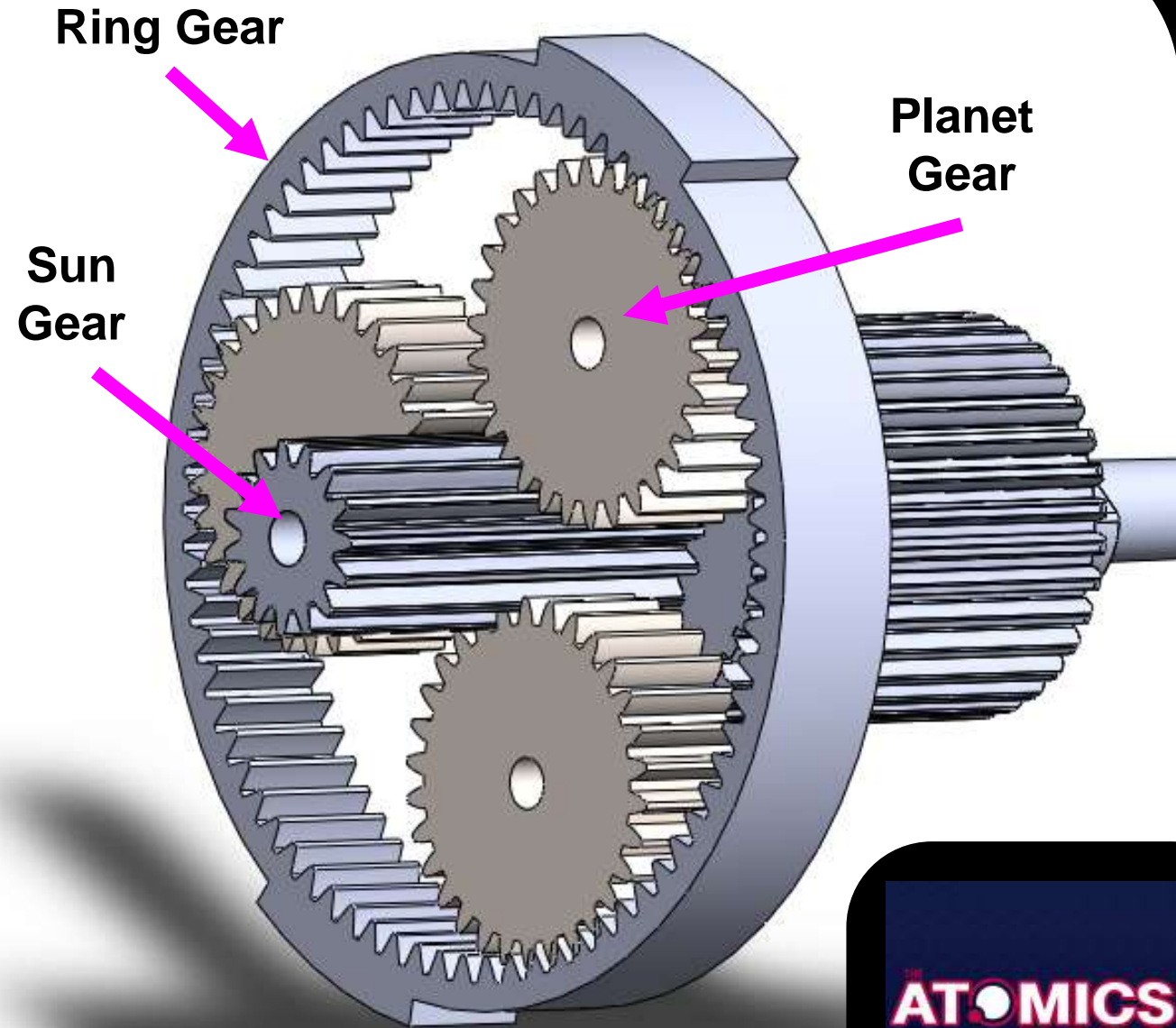



# Planetary Gearboxes at work

Real world examples found in the wild

Pencil Sharpener

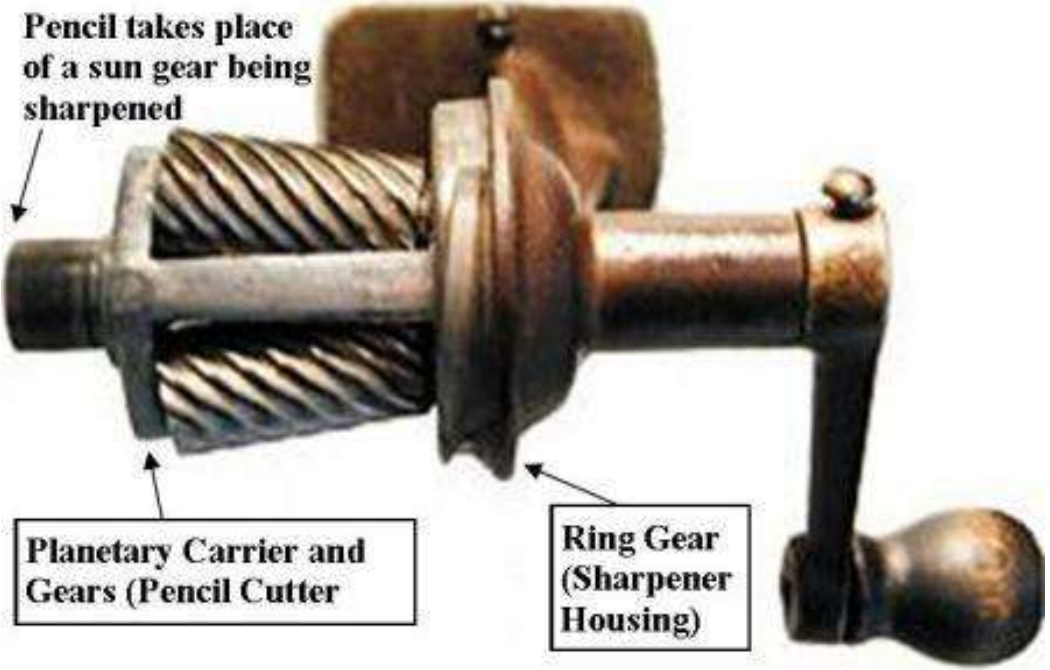

Cordless Drill Gearbox

# Gearboxes

## Modular Planetary (VersaPlanetary Gearbox)

Fully-customizable, multi-stage gearboxes.

### Pros:

Lightest/most compact, Wide range of possible configurations and accessories.

### Cons:

Can fail under excessive loads, multistage builds may be too long to fit.

VersaPlanetary Gearboxes in various configurations



# Gearboxes

## Linear Actuators

(DART actuator, Armabot Power Lift)

Very uncommon due to cost/weight.  
Basically an electric alternative to  
pneumatic cylinders.

### Pros:

Allows for linear motion using motors,  
high torque

### Cons:

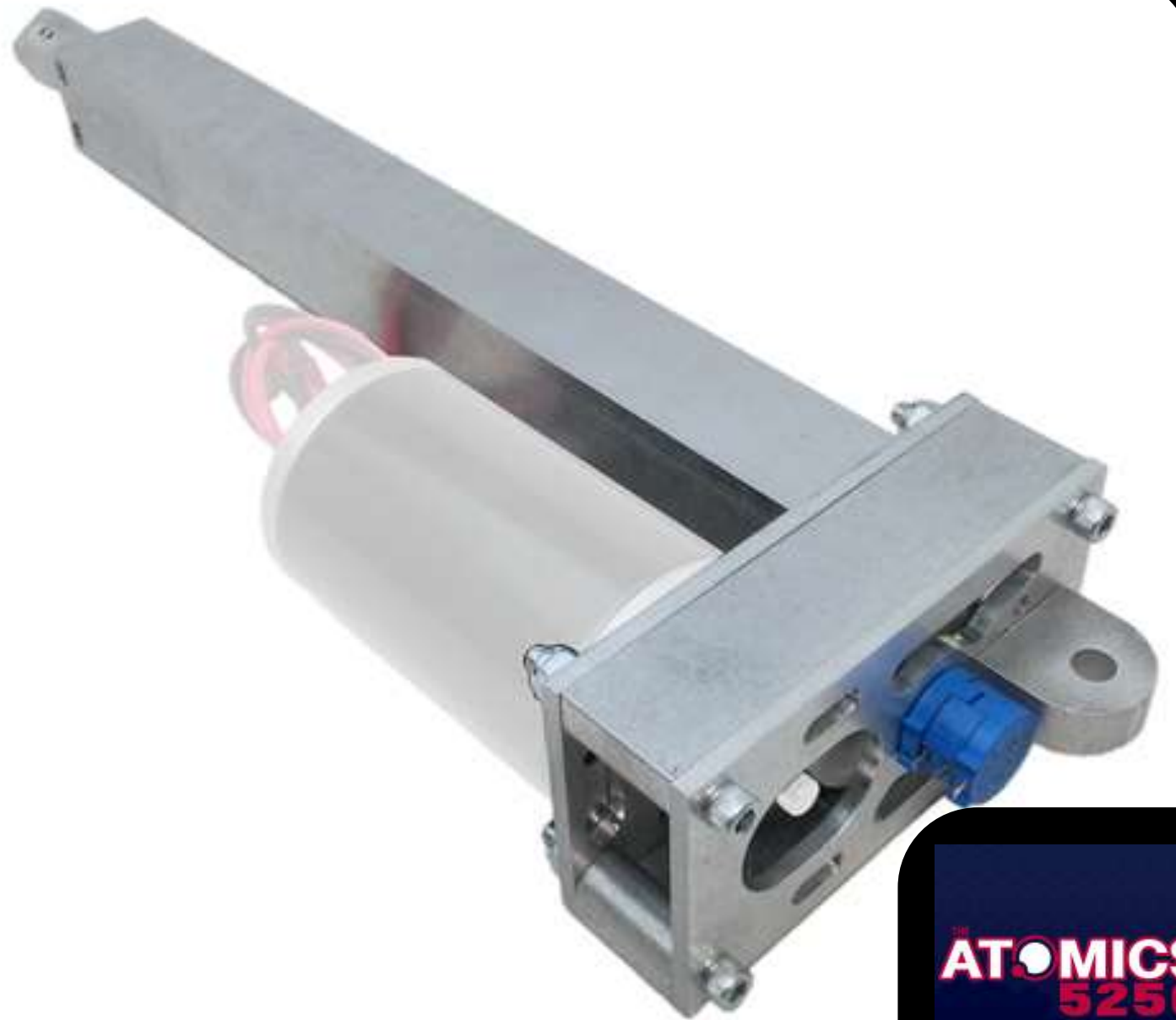

Very expensive; Heavy, Bulky, Slow.



12" Stroke Dart Linear Actuator

# Section 9: Gearboxes

## Skills

-  Identify the 5 major gear types covered in this section.
-  Determine correct replacement gears in a geartrain using tooth count, DP, and bore.
-  Learn to use JVN's Mechanical Design Calculator to determine overall gear ratios.

## Review Questions

1. What gear, mounted on parallel shafts, is the most common type?
2. True or False: A cable winding around a spool will change the overall gear ratio of a mechanism?
3. A hand-cranked pencil sharpener is a real-world example of what kind of gearbox?

## Section 10

# Mechanical Power Transmission

# Transmission

## SHAFT

(Round and Hex Shaft Stock)

Primary means of enabling power transmission for most entries in this section.

- Rotating machine element, usually circular or hexagonal in cross section
- Transmits power from one part to another
- Used for mounting pulleys and gears



Can you find all 2 shafts in this AM Toughbox Mini?



# Transmission

## Direct Gearing

(AM Nanotubes, Vex Clamping Gearbox, FTC builds)

Gear-to-gear transfer of power; Primarily used in high torque applications, such as arms; Uncommon in drivetrains outside of FTC/Vex.

### Pros:

Efficient transfer of power, robust.

### Cons:

More added weight and complexity, Costly, not practical for distances.

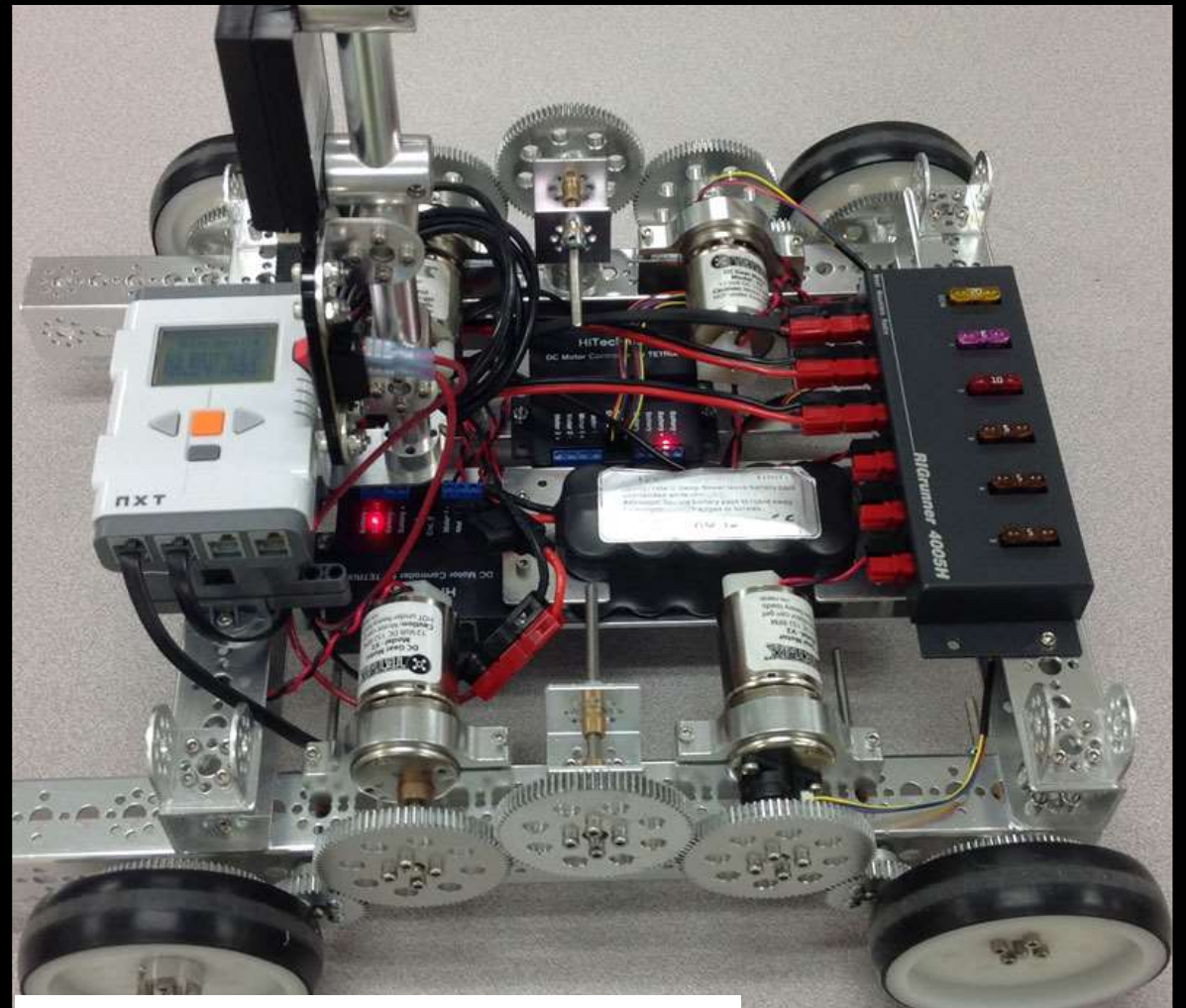

Example of direct gearing in an FTC drivetrain

# Transmission

## #25 Roller Chain

(Used in electric scooters and pocket bikes)

Transfer of power in drivetrains and mechanisms

### Pros:

Fairly quick and easy, good strength, lighter than #35 chain.

### Cons:

Lower tensile strength than #35 chain, may stretch after install, harder to find #25 parts.



#25 Roller Chain

# Transmission

## #35 Roller Chain (Used in older MiniBikes)

Transfer of power in drivetrains and mechanisms

### Pros:

Fairly quick and easy, parts common, stronger than #25 chain.

### Cons:

Heavier than #25 chain, may stretch after install.



# Transmission

## Sprocket

(#25 and #35 Roller Chain)

A toothed-wheel designed to mesh with roller chain.

### Pros:

Parts readily available; Allows for changes in gear ratio.

### Cons:

Heavier than belt pulleys; Chain can skip teeth when under extreme loads.

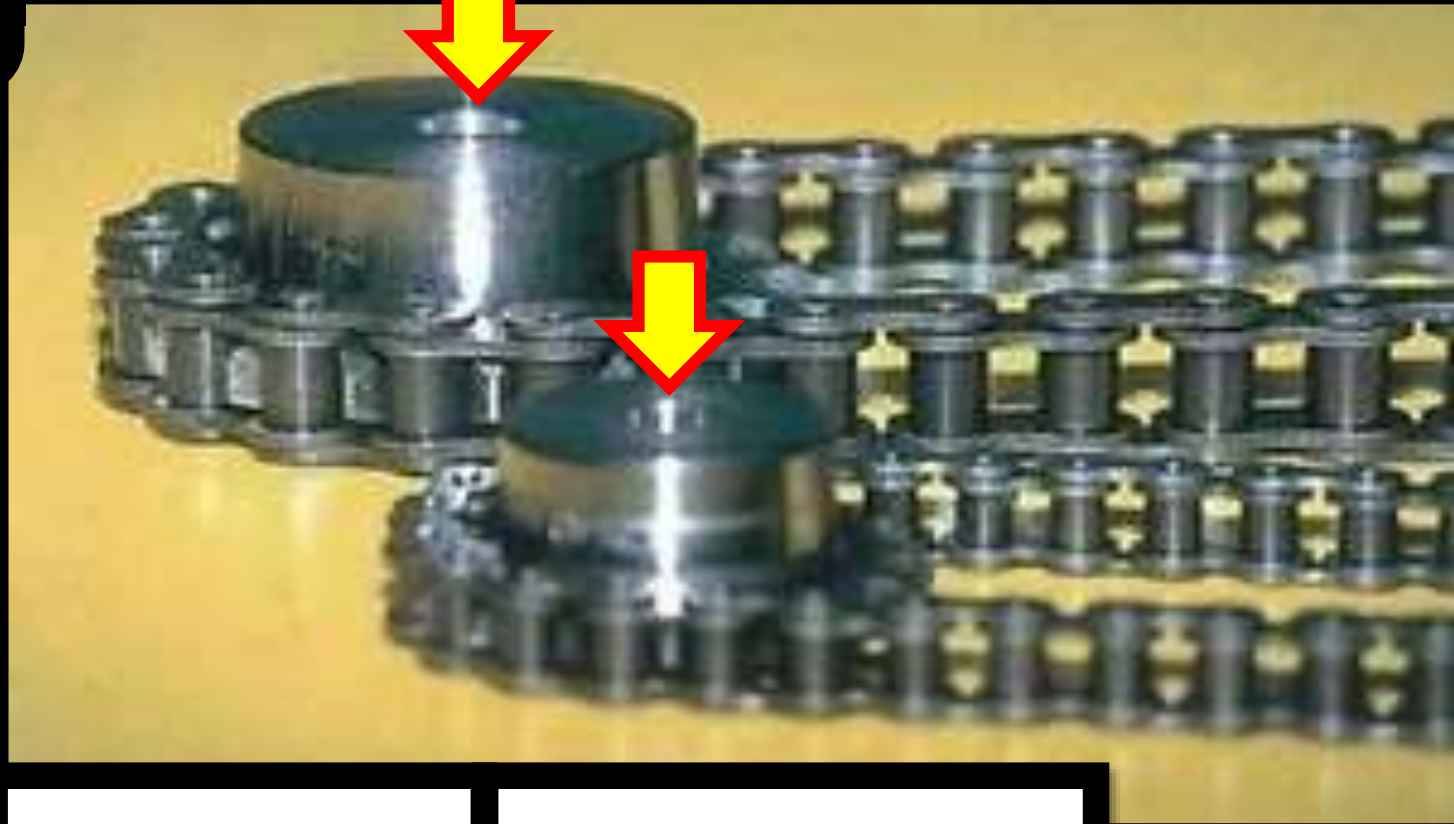

# Transmission

## Synchronous Belt (HTD Belts)

Flexible belt with teeth molded onto its inner surface, designed to run over matching toothed pulleys.

### Pros:

Lightweight and reliable with consistent performance (does not “stretch” like chain).

### Cons:

Can be difficult to get pulley spacing and tension correct in custom builds;  
Replacement usually involves disassembly of pulley axles.

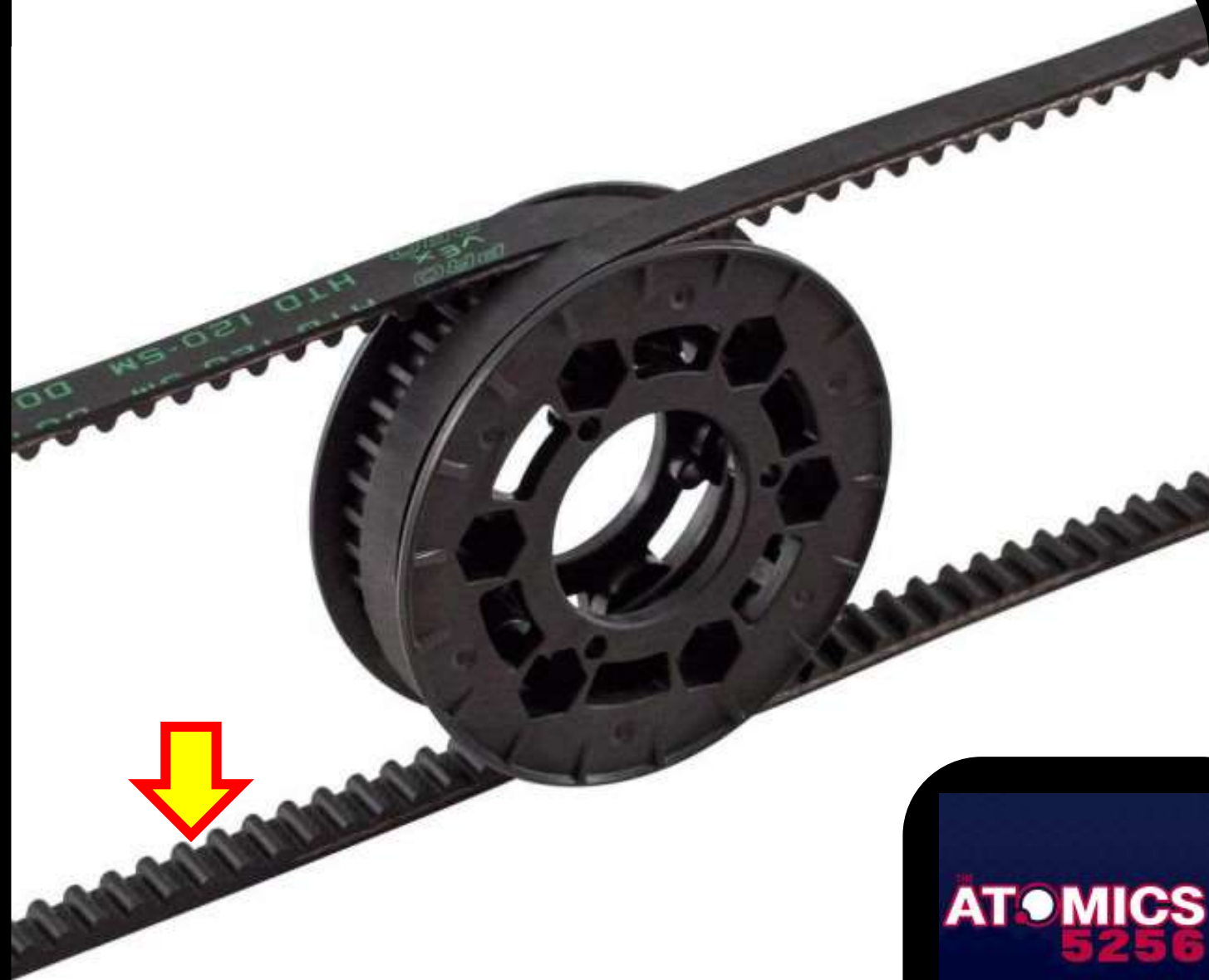

2 Vex 120 Tooth x 9mm HTD 5mm belts on a Versa pulley

# Transmission

## Belt Pulley (For HTD Belts)

Toothed pulleys designed to mesh with flexible synchronous belts.

### Pros:

Lighter than sprockets; Large amount of toothed surface area to mesh with belts;  
Some hubs are designed for 2 belts.

### Cons:

Belt slippage can occur; Less sizes available than sprockets—not suitable for gear reductions.



ATOMICS  
5256

# Transmission

## Urethane Round Belt

**Flexible round belt available in solid and hollow core;  
Commonly used for conveyors and intakes.**

Ends of material can be welded together by using a milled jig  
(*shown below*), and following these steps:

1. Melt ends with heat gun
2. Place the molten ends together with some force into the clamping jig (screw a hinge to 2 pieces of aluminum block and drill a properly sized hole across)
3. Clamp the block down on the belt, a second person is advised for this step
4. Trim the tabs of squished material off the belt .

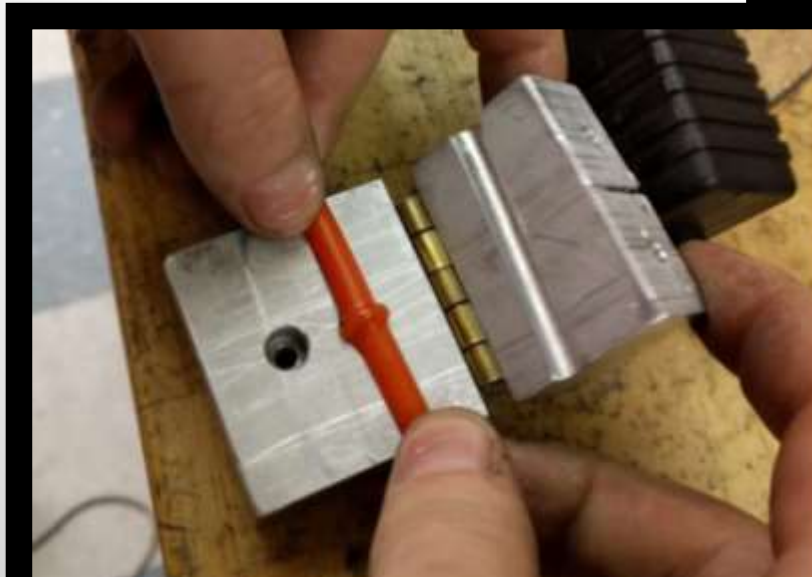

# Transmission



## Bead Chain

(Raymor Sprockets)

Transfer of power in non-standard orientations for low speed/torque applications.

### Pros:

Sprocket can drive rotated pulleys, or if routed through Bowden tubing, around corners, through holes, etc.

### Cons:

Low-tensile strength, relatively difficult assembly, recommended for <100RPM.

*Note: As far as I know, no one is actually using this in FRC. I just thought it was cool and wanted to share. But, hey, you're welcome!*



Bead chain routed from motor (right), through PTFE Bowden tubing, to an output shaft (left).

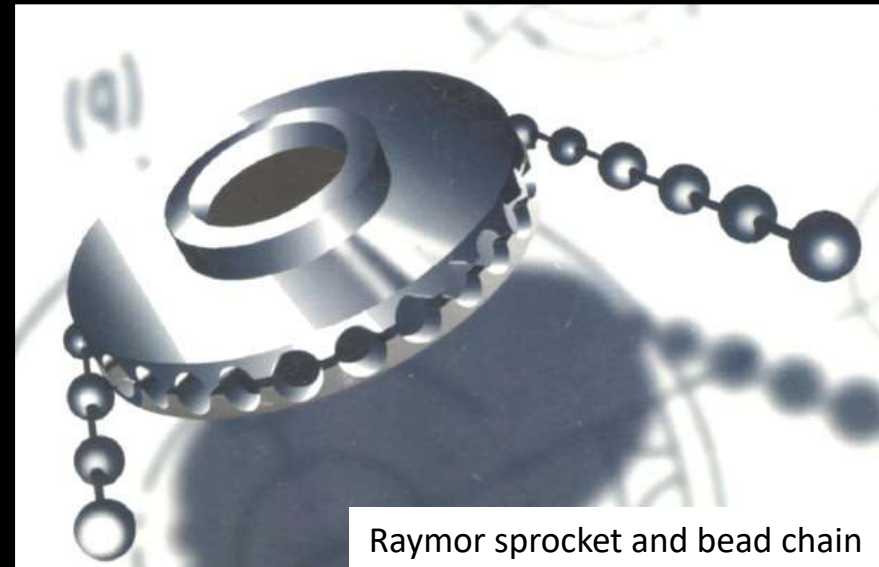



Raymor sprocket and bead chain



# Section 10: Transmission

## Skills

-  Resize a length of roller chain using a chain breaker.
-  Determine the effect of different sprocket or pulley diameters in a gear train.
-  Assemble a KOP drivetrain HTD pulley assembly.

## Review Questions

1. Which type of roller chain is commonly used on scooters?
2. True or False: Roller chain does not stretch, unlike belts.
3. Why are synchronous belts often harder to work with than roller chain?

## Section 11

# Passive & Stored Energy



# Passive/Stored

## Extension Springs

Attached at both ends to other components that, when moved apart, the spring tries to bring them together again. Extension springs absorb and store energy as well as create a resistance to a pulling force. This tension can be manipulated to achieve the load requirements of a particular application and come in a range of sizes.

Extension springs are also useful for maintaining tension on cabling systems that are prone to stretching or partially loosening, such as those found on cascading extension lifts.

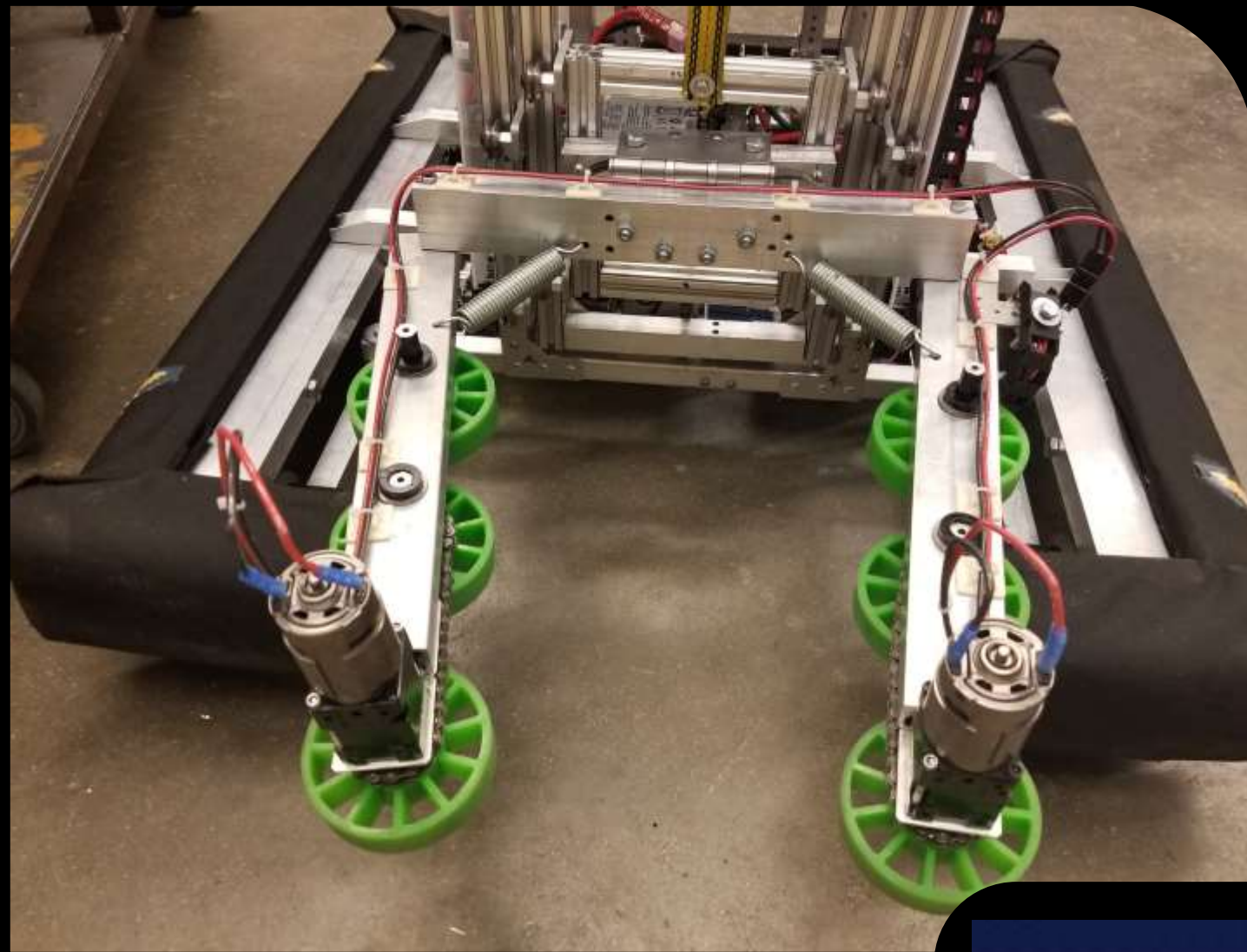

# Passive/Stored

## Compression Springs

Compression springs offer resistance to linear compressing forces. Generally placed over a rod or fitted inside a hole, compression springs push back against a load and in order to get back to its original length.

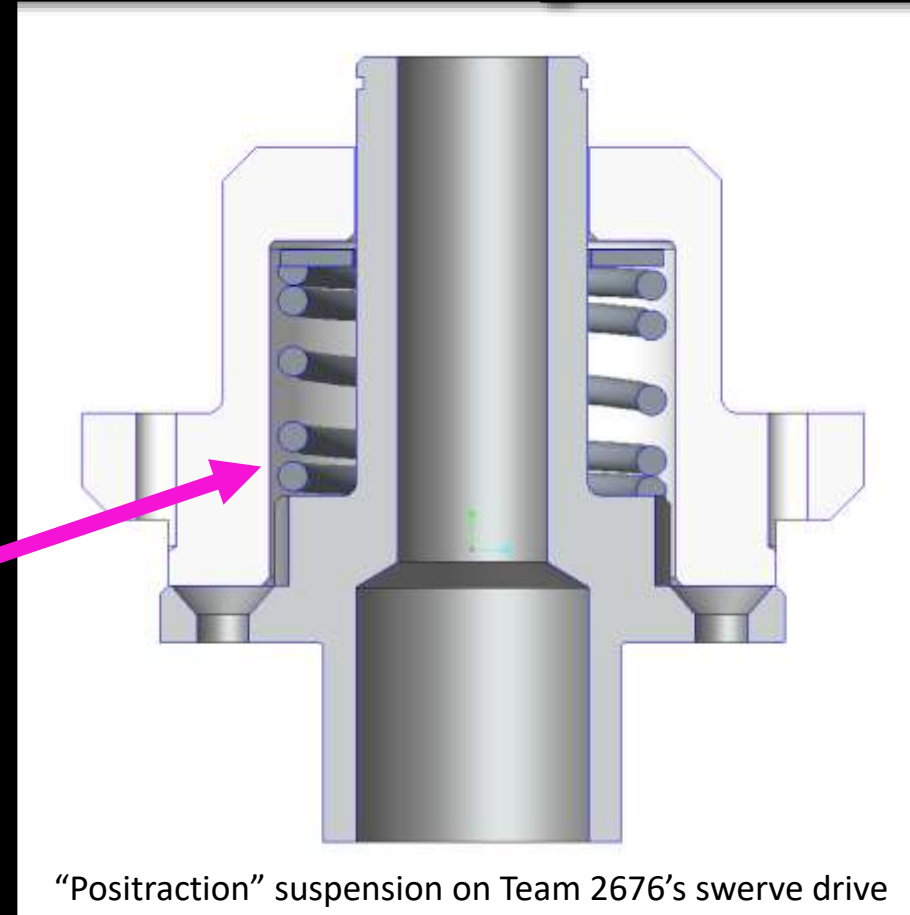
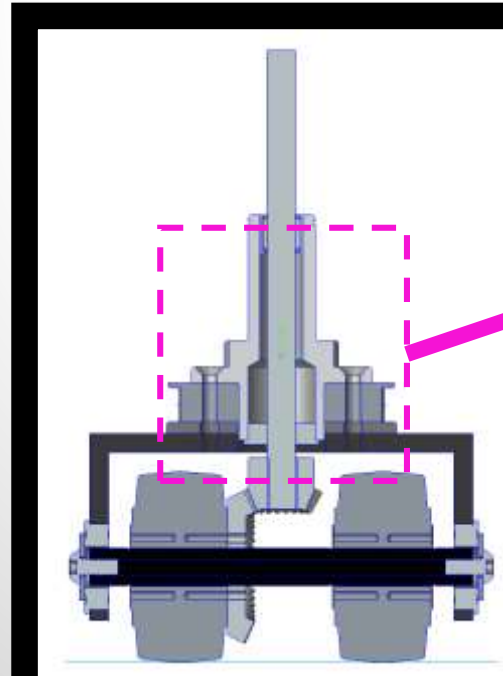
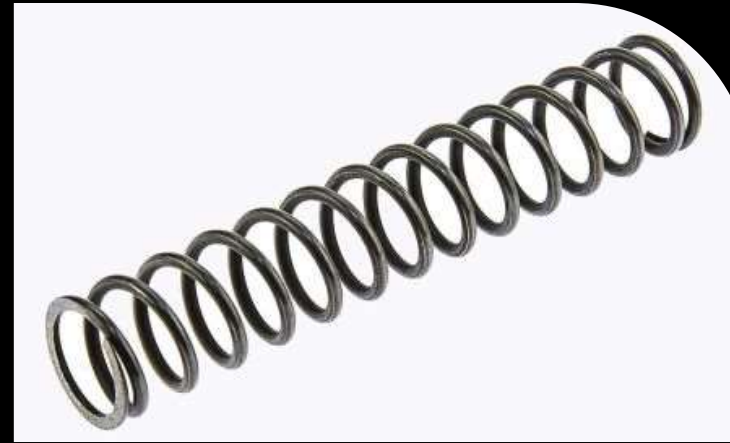

"Positraction" suspension on Team 2676's swerve drive

# Passive/Stored

## Constant Force Springs (Vulcan Springs)

Flat steel springs in a variety of sizes and strengths designed exert a pulling force on linear mechanisms. Frequently used on elevators to reduce the load on the motor. Handle with care.



**WHO WOULD WIN?**

**40LB CONSTANT  
FORCE SPRING**



**ONE FLESHY BOI**



**ATOMICS  
5256**

# Passive/Stored

## Surgical Tubing

Hollow stretchy latex tubing commonly used for prototyping, quick fixes, and even finished products. Simple and fairly reliable, but it can lose its elasticity relatively quickly and older stock can dry out and become somewhat brittle.

Surgical tubing is also a great quick pit fix for pneumatic cylinders or constant force springs.

It can be tied or strapped on and multiple spans can be used to increase tension when needed.



## Section 12

# Control System Overview

# Controls

## Battery

### Sealed Lead Acid (SLA) Battery

- Power source of robot
- 12V, 18Ah
- Connects to main breaker and Power Distribution Panel (PDP)



12V SLA Battery



# Controls

## Main Breaker

### Sealed Lead Acid (SLA) Battery

- **Turns robot on and off**
  - Push black switch in to turn on.
  - Press big red button to turn off
- **Connects to PDP and Battery**
  - Wires to positive side of both
- **Stops the flow of current if there is too much drawn.**



Main Breaker

# Controls

## Power Distribution Panel (PDP)

- Distributes power from battery to rest of robot.
- Uses breakers to restrict how much power is sent.
  - 40 and 30 amp channels.
  - Accepts 10, 20, 30 & 40 amp Snap Action Breakers.
- Generally terminates CAN\* bus connections.

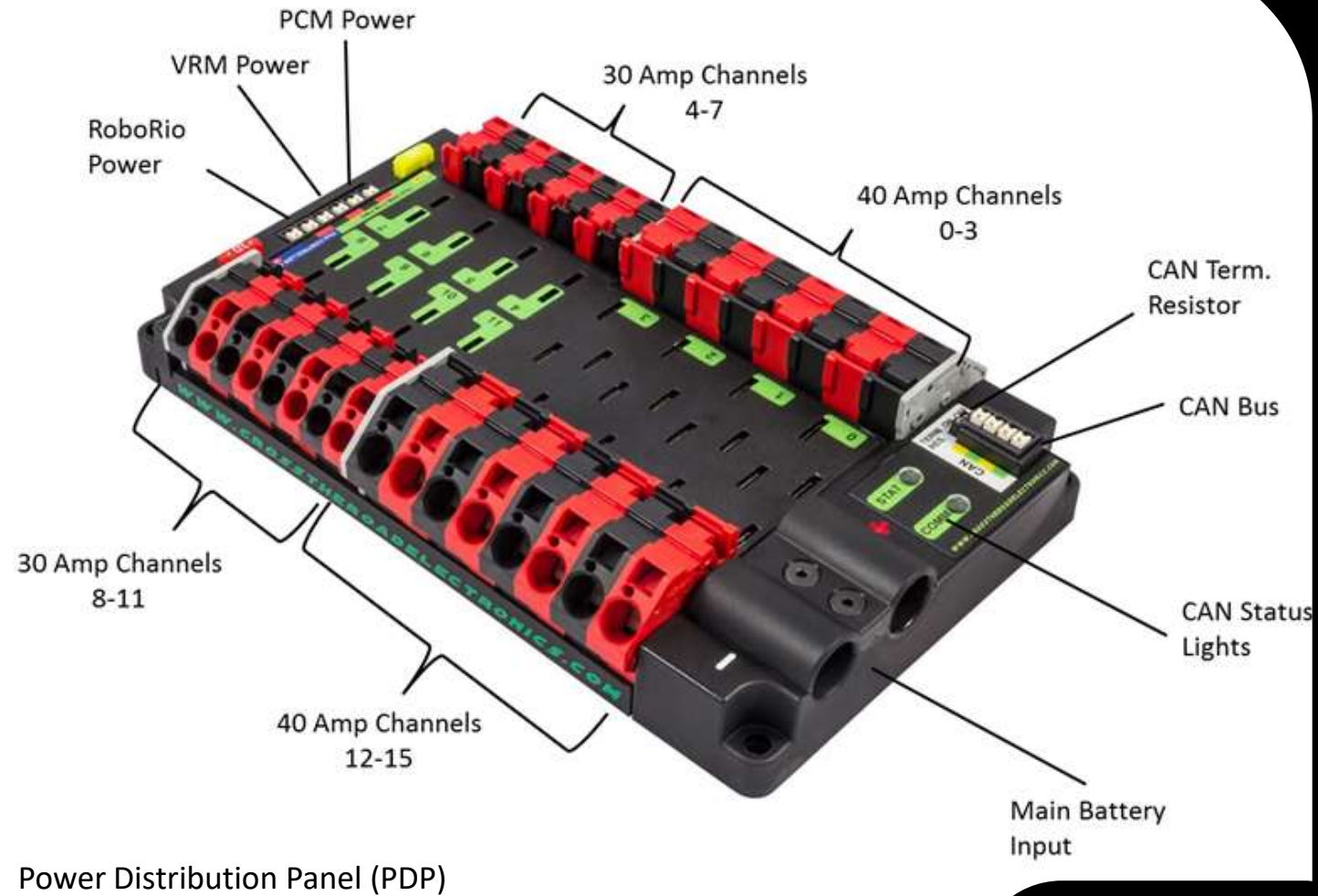

# Controls

## Snap Action Circuit Breakers

- Plugs into the PDP
- Used to limit current to branch circuits.
- Uses breakers to restrict how much power is sent.
- Available in 10, 20, 30, and 40 AMP ratings.



40 amp Snap Action Circuit Breaker

# Controls

## PWM Motor Controllers

- Receives power from the PDP
- Supplies power to motors.
- Receives control signal via PWM from the RoboRio.
- Controls the speed and direction of the motor it supplies with power.



Clockwise from top-left: CTRE Talon, Rev Spark, Vex Victor 888, and CTRE Victor SP



# Pulse Width Modulation (PWM)

**Pulse width modulation**, or **PWM**, is a method of a control signal using electrical pulses. This may sound complicated, but it's really not.

PWM uses 5 volts, which can either be on or off. By varying the ratio of time on to time off, different signals are created. These signals can be used to control anything from the brightness of LEDs, to servos and motor controllers. It's sort of like Morse code.

The term **Duty Cycle** is used to describe the ratio of time on to time off. The graphic at the right shows 3 examples of different duty cycles. Devices such as motor controllers and servos interpret different duty cycles as messages telling them what to do.

The graphic at bottom right illustrates how varying (modulating) the duration (width) of on time for the 5v electrical signal (the pulse), is used to control the rotation of a servo motor.

PWM can also be used to supply voltage to motors or other components, by achieving an average of on to off time. For example, a 24v power source with a 50% duty cycle is essentially supplying 12v, while at 75% it would supply 18v and so forth.

However, in FRC, PWM is primarily used as a control signal.

50% duty cycle



75% duty cycle



25% duty cycle

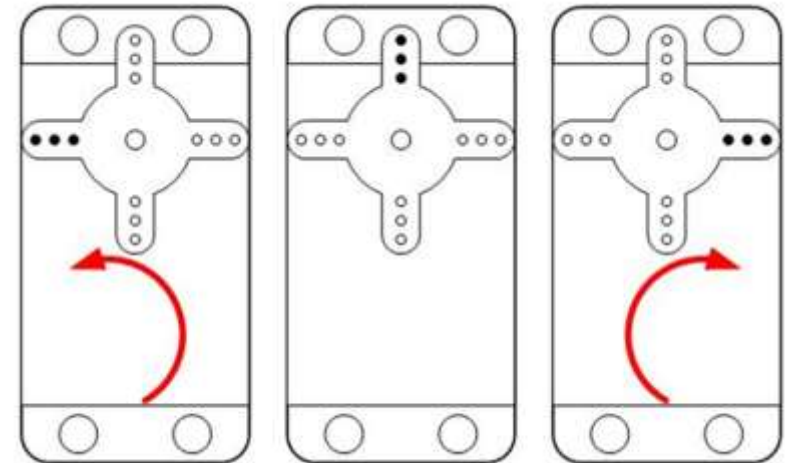

Left Position

Center Position

Right Position

1 ms

1.5 ms

2 ms



# Controls

## CAN Motor Controllers

- Receives power from the PDP
- Supplies power to motors.
- Designed to be part of a CAN Bus network, but can receive PWM from the RoboRio as an alternative.
- Can be configured to control or be controlled by other CAN Bus devices.
- Controls the speed and direction of the motor it supplies with power.

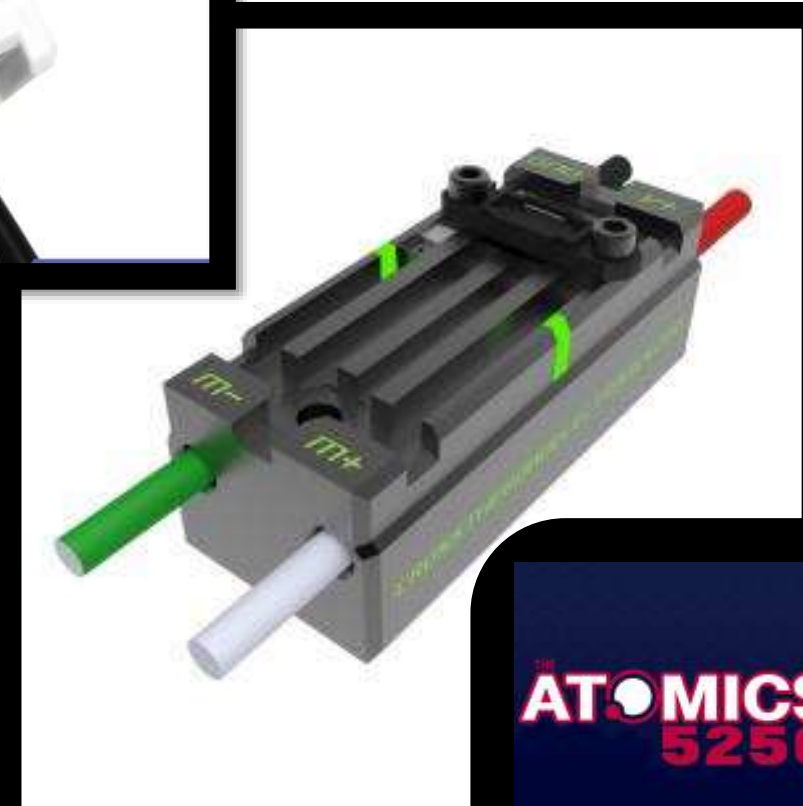

Clockwise from top-left: Rev Spark Mac, CTRE Talon SPX, and CTRE Talon SRX



# Control Area Network (CAN Bus)

**CAN Bus** was created by the automotive industry in the mid-80's as a cost cutting measure. At the time, vehicles were using more and more electronics, which resulted in bulky wire harnesses that were heavy and expensive. CAN replaced dedicated wiring with in-vehicle networks, which reduced wiring cost, complexity, and weight. Since then, CAN has been adopted by fields ranging from aerospace to automation. One higher-level protocol based on CAN, DeviceNet, is commonly used in industrial control systems, including the Field Management System (FMS) used by FIRST.

Where PWM only sends very simple number values from 0%-100% one way, CAN's message based protocol allows multiple daisy-chained devices to send and receive raw data. It also prioritizes these messages and is able to correct errors through redundancy across the network. This is why CAN devices are able to handle tasks such as maintaining the same motor speed on a shooter or intake.

From a wiring standpoint, CAN Bus makes for a cleaner setup. While PWM requires individual cables running parallel from the RoboRio to each device—a scenario that can quickly turn into a tangled mess—CAN only needs 2 wires in serial as shown at right.

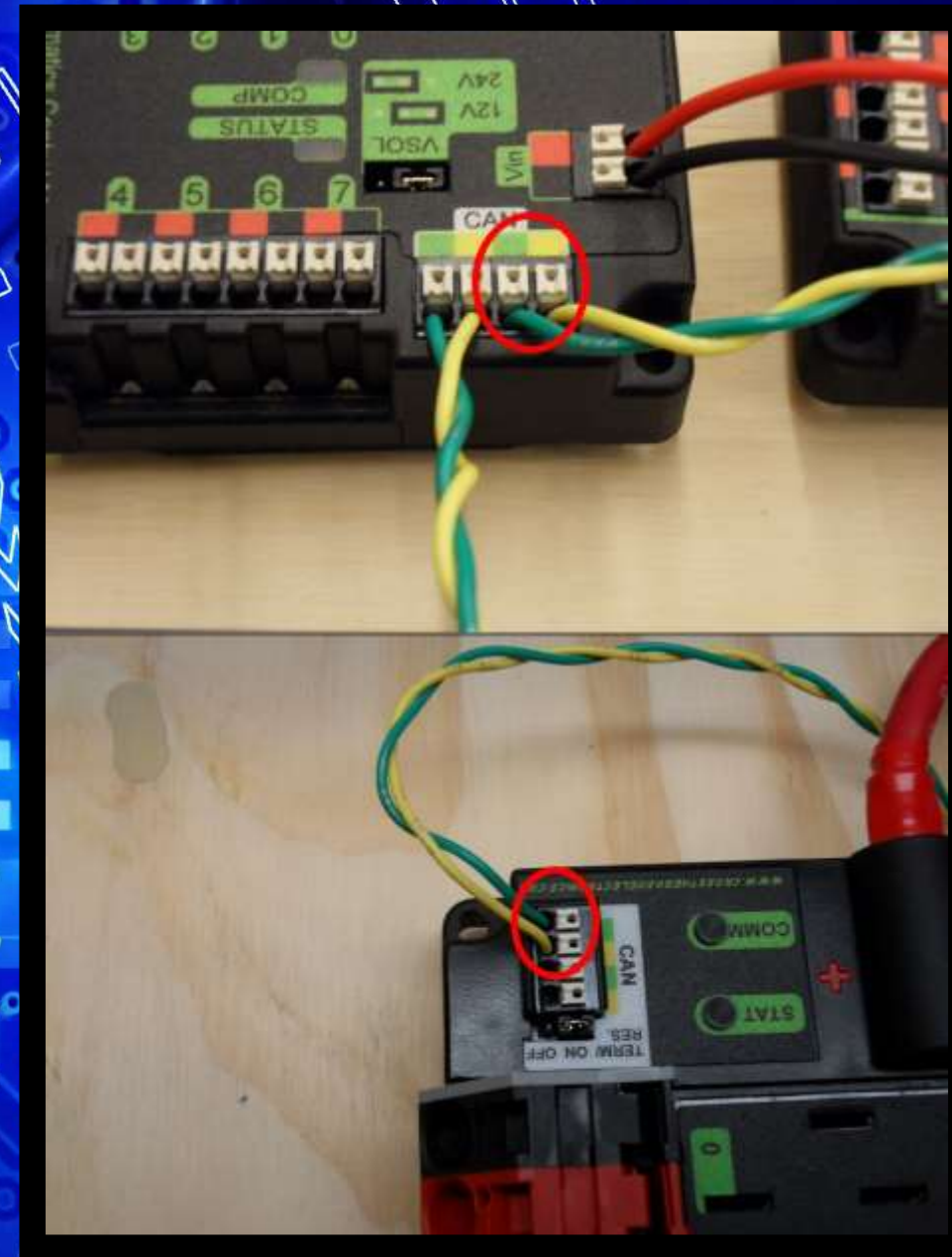





# CAN Bus—Making Sense of Stuff You Never Wanted to Know!

- 1 Like Yelling "Attention!"
- 2 Puts *engine on fire* in front of *low washer fluid* in terms of importance
- 3 A classroom full of kids raising their hands
- 4 Tells how much info will be sent so it can be error checked if its wrong
- 5 The actual data being sent
- 6 Checks 4 and 5 and sees if they match up to help determine if the info is correct.
- 7 Announces outcome of 6
- 8 End of Frame: Denotes end of message

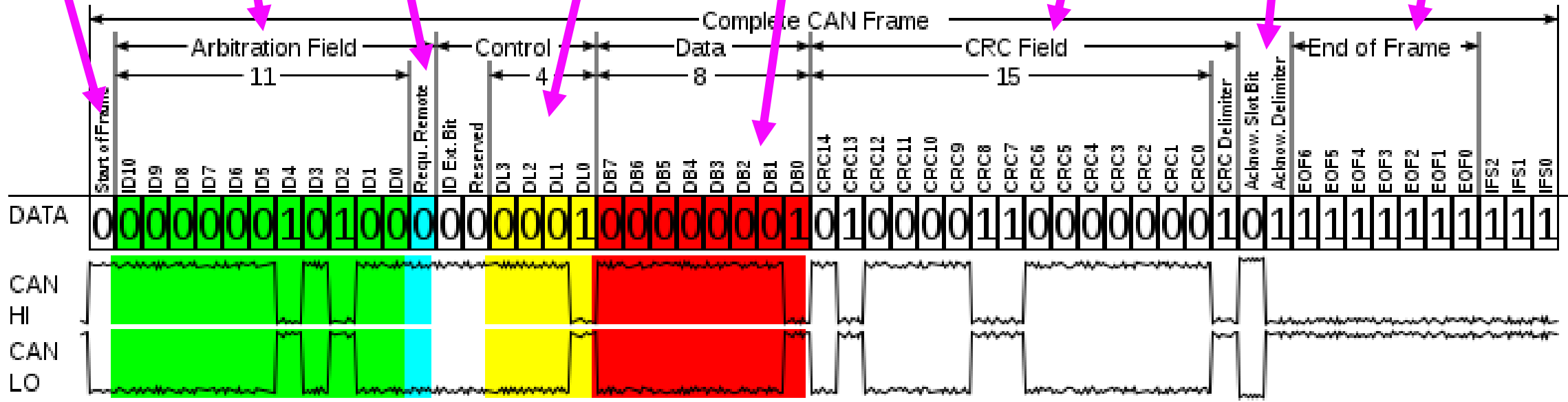

# Controls

## Voltage Regulator Module (VRM)

- **DC to DC converter with both boost and buck voltage regulation.**
  - **Boost Converter:** Steps up voltage while stepping down current.
  - **Buck Converter:** Steps down voltage while stepping up current.
- **Used when components require special protected power.**
  - Router
  - Light Ring
  - Flashlight

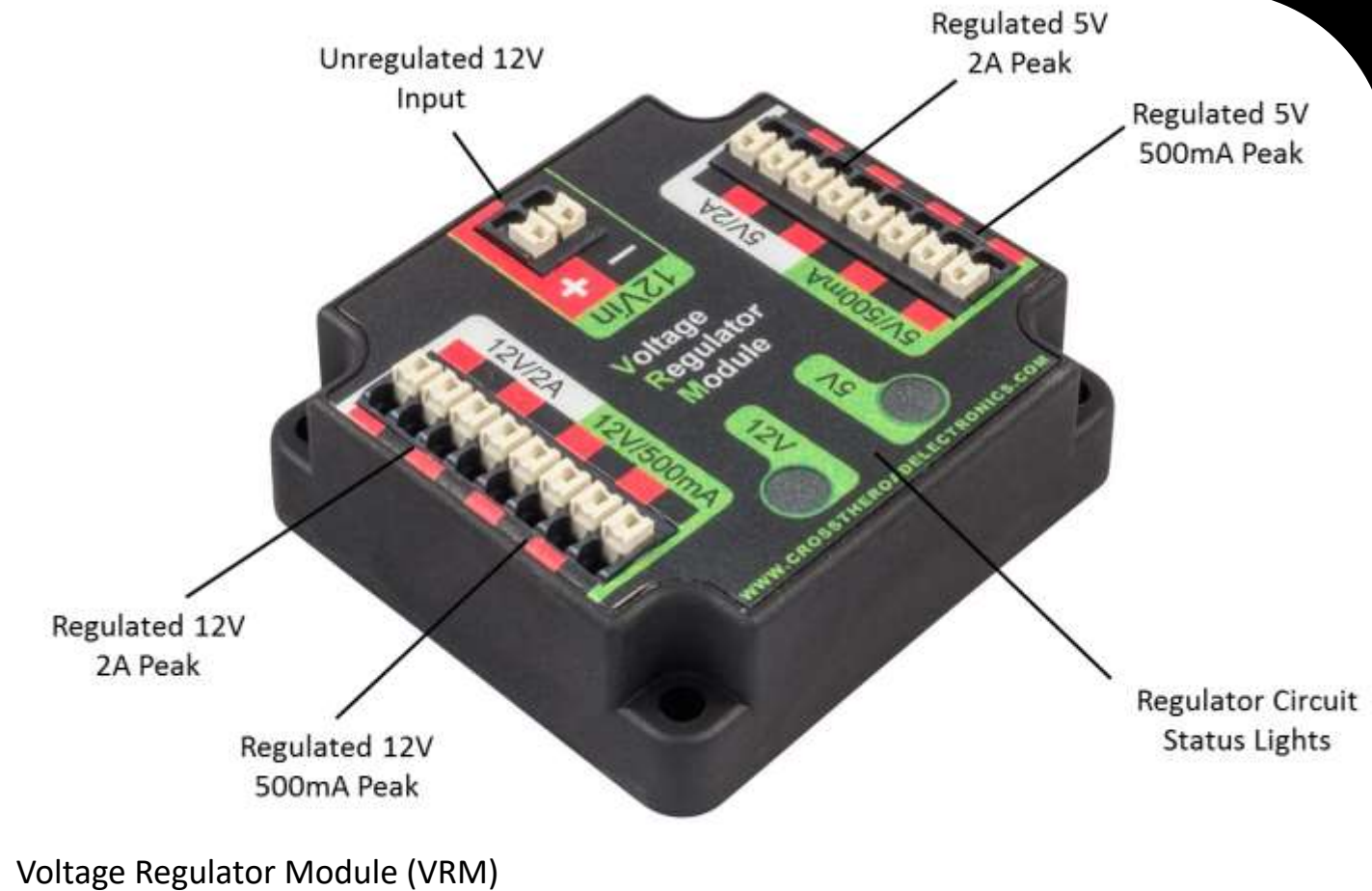

# Controls

## Pneumatic Control Module (PCM)

- Sends signals to solenoids to actuate cylinders
- Controls compressor
- Contains 7 channels for solenoids
- Communicates with RoboRio via CAN Bus.
- Sometimes used in non-pneumatic systems to terminate CAN wires.

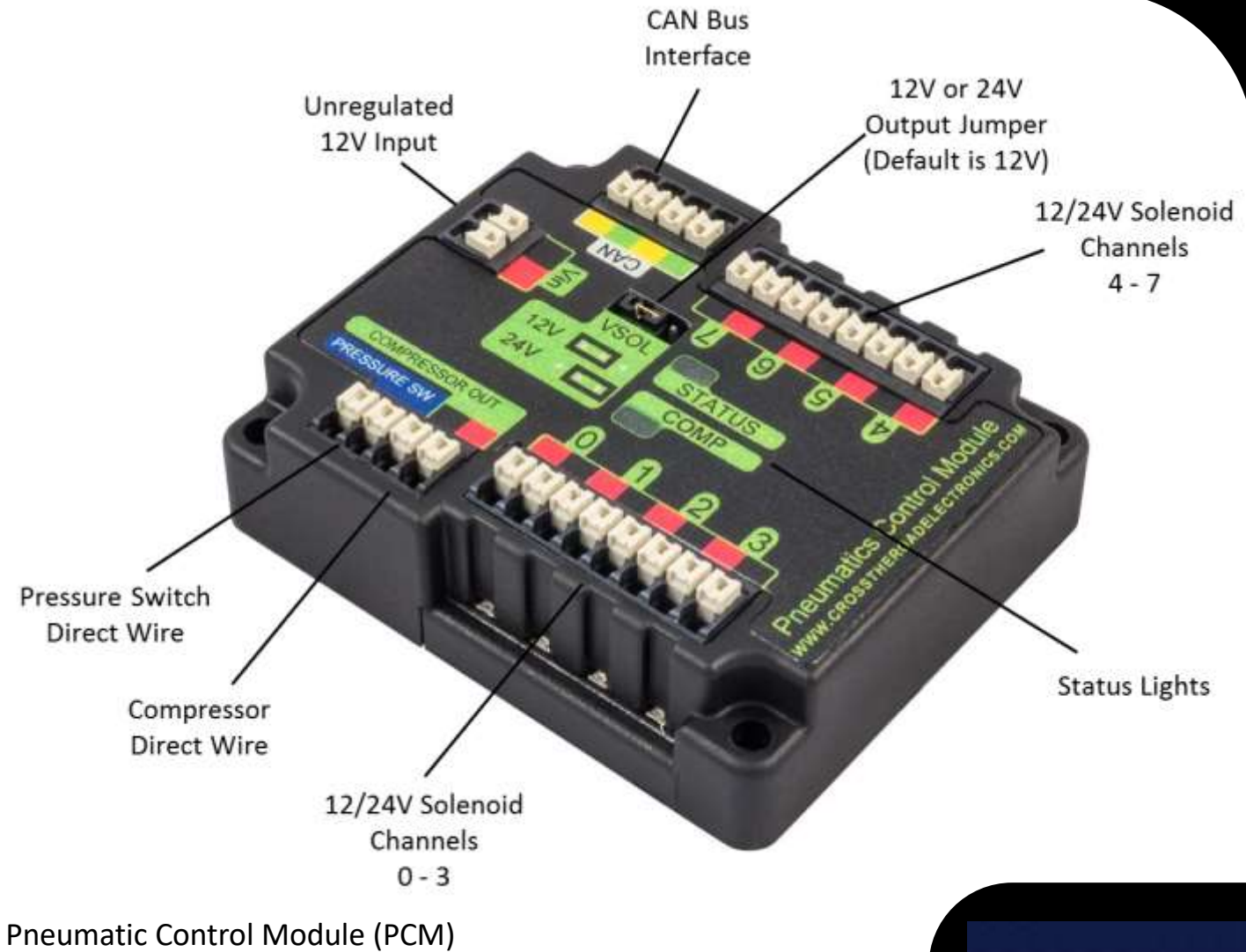

# Controls

## Open-Mesh OM5P-AC (Dual Band 1.17 Gbps Access Point)

- Onboard WiFi lets us connect to the robot and control it from a nearby computer
- Communicates with the RoboRIO over ethernet.
- Connects to VRM for power. Can be used with a Power over Ethernet (PoE) injector.
- **Must be configured at competitions**
  - Needs to be reflashed with updates to work with the Field Management System (FMS)



Open-Mesh OM5P-AC Access Point/Router

# Controls

## NI roboRIO

### (Advanced Robotics Controller)

- **Brain of the robot**
  - Where code is uploaded and ran.
  - Sends signals to CAN chain and PWM.
  - Has Digital and Analog In ports for sensors.
- **Has port for signal light**
  - Signals when robot has been enabled.
- **Ethernet port to connect to router to allow tethered control of the robot.**
- **USB ports for devices (camera, etc.)**

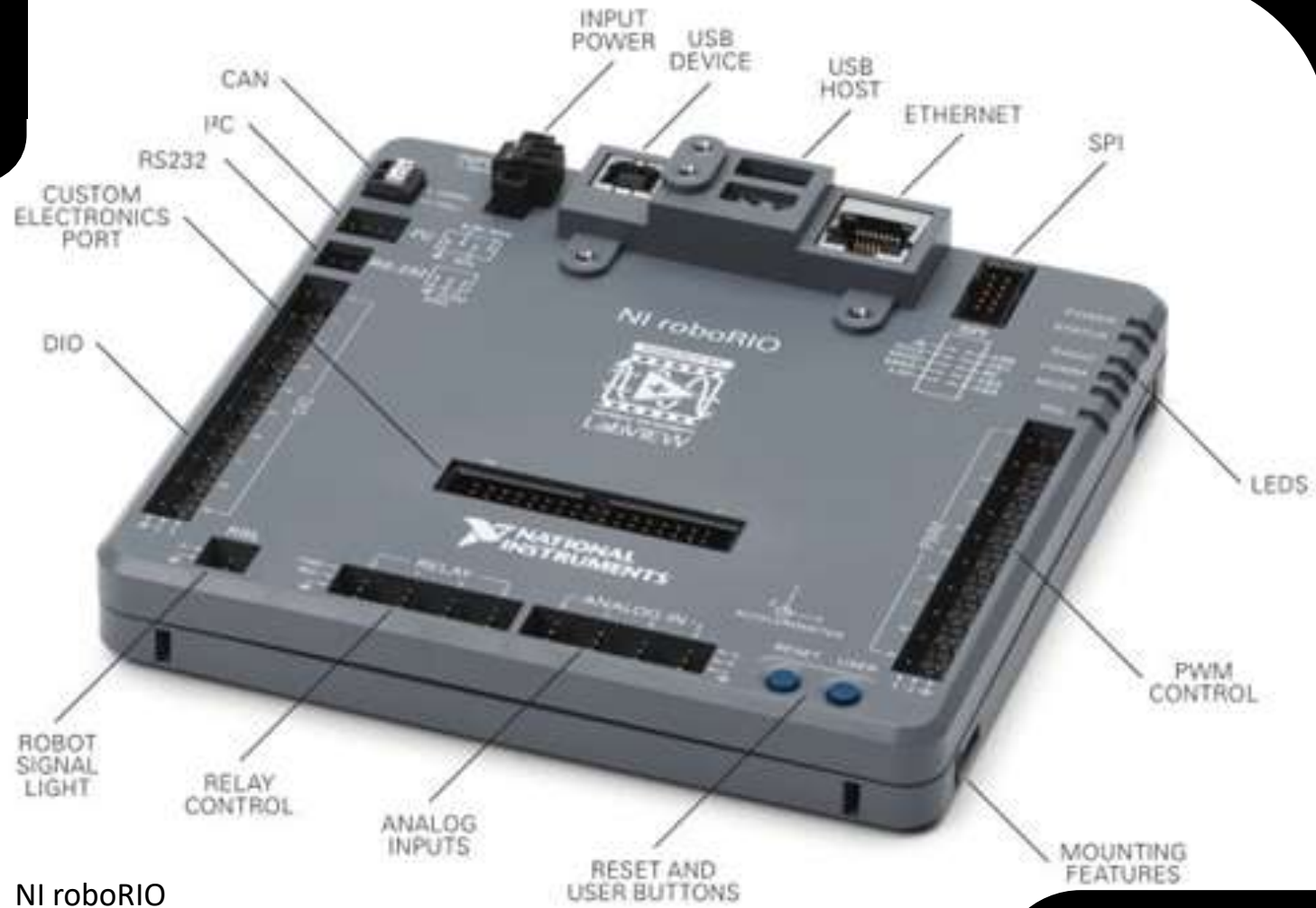

## Section 13

# Wiring

# Wiring

## Topics Covered



**Tools and  
Equipment**



**Wire and  
Cable**



**Terminals and  
Connectors**



# Tools and **Equipment**



# Wiring

## Wire Strippers

- Strip insulation off wires
- Available in a wide variety of styles ranging from no-frills adjustable strippers to automatic self-adjusting models.
- Gauged strippers are probably the best all around for bench work.
- Self-adjusting auto strippers are more consistent and ergonomic for repetitive work with the same wire gauges.

These are just a few of the types of strippers available. As with any tool, some are more suited for some jobs than others. Self-adjusting strippers, like those shown at right, might be great for 12awg wire, but may not work with 22awg hookup wire.



Self-adjusting Stripper



Gauged Stripper

Adjustable stripper



ATOMICS  
5256

# Wiring

## How to Strip a Wire

Safe, durable electrical connections begin with clean, accurate wire stripping. Removing the outer layer of plastic without nicking the wires underneath is critical. If a wire does get nicked, the connection may break or an electrical short may occur.

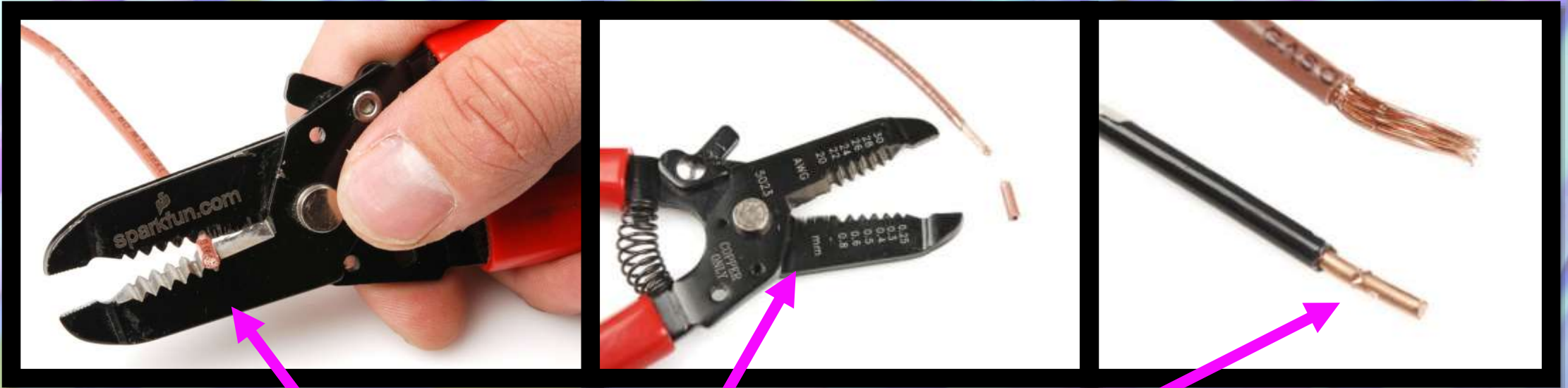

A simple manual wire stripper is a pair of opposing blades much like scissors. By simply squeezing the handles about  $\frac{1}{4}$ " from the end of the wire or the desired length, using the correct notch on the tool, and then twisting it slightly, the insulation will be cut free.

By pulling the wire strippers towards the end of the wire, the insulation should slide right off of the wire.

It is important to match the size of wire to the correct notch in the stripper. If the notch is too large, the wire will not get stripped. If the notch is too small, there is a risk of damaging the wire.

# Wiring

## Wago Tool

- Used to open Wago terminals on the PDP
- A small flat blade screwdriver will also work.

Fully insert Wago tool, or flat blade screwdriver, into the rectangular hole at a shallow angle then angle upwards as you continue to press in to actuate the lever, opening the terminal. Take care not slip when applying force because it is easy to break off plastic tabs in the rectangular hole

Insert Wago tool in rectangular hole

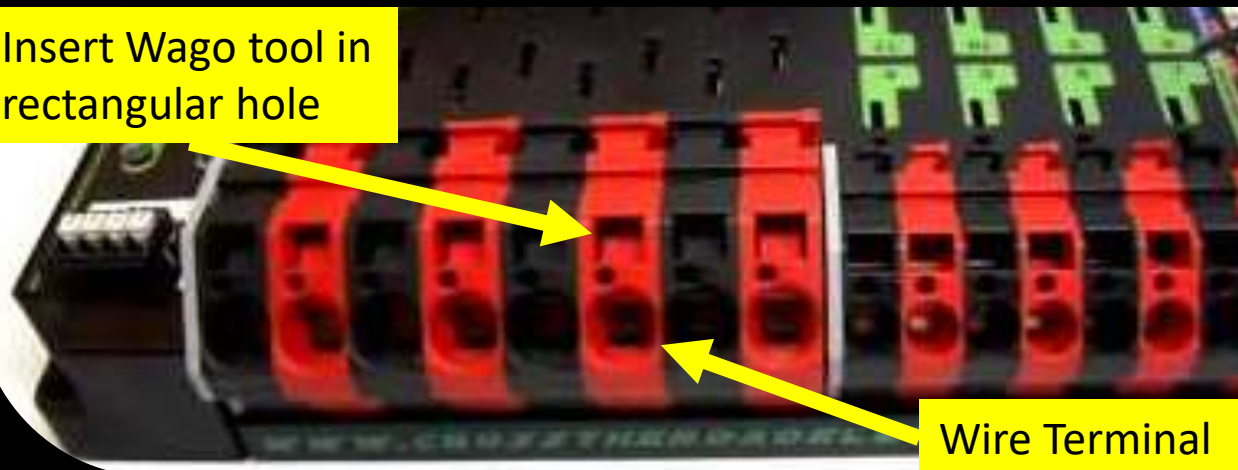

Wire Terminal



ATOMICS  
5256

# Wiring

## Terminal Crimpers

- Used for making secure mechanical connections between wires and terminals.
- There are many styles of crimpers, some are versatile, while others are designed for specific usage.
- Important to use the correct dies or tool gauge along with quality terminals for good results.

Terminal Crimpers



Ratcheting Crimpers



Battery Terminal Crimpers



# Wiring

## How to Crimp a Wire

Learning to crimp basic wire terminals is a simple skill that every aspiring maker or roboticist should check off their list. When properly done, solid mechanical wire connections are equal or greater to soldering in terms of reliability.



Insulated terminals are selected by a range of sizes noted by the color.

- Red- 22 to 16 gauge
- Blue- 16-14 gauge
- Yellow- 12-10 gauge

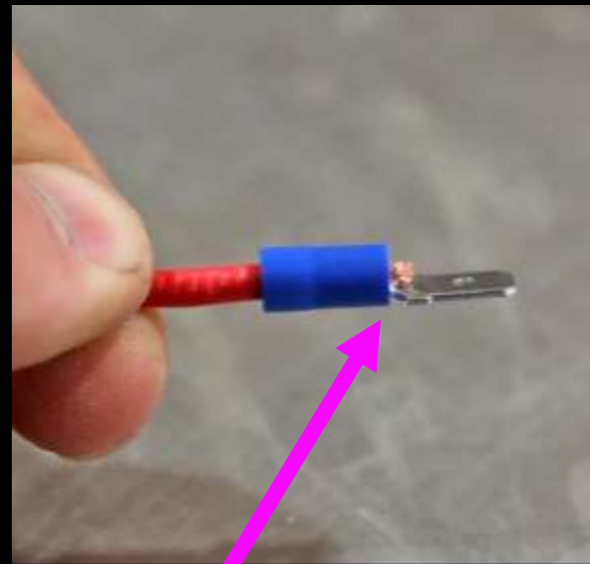

Make sure all of the wire makes it into the terminal. An easy way to do this to give the wire a couple of twists after stripping the insulation away..

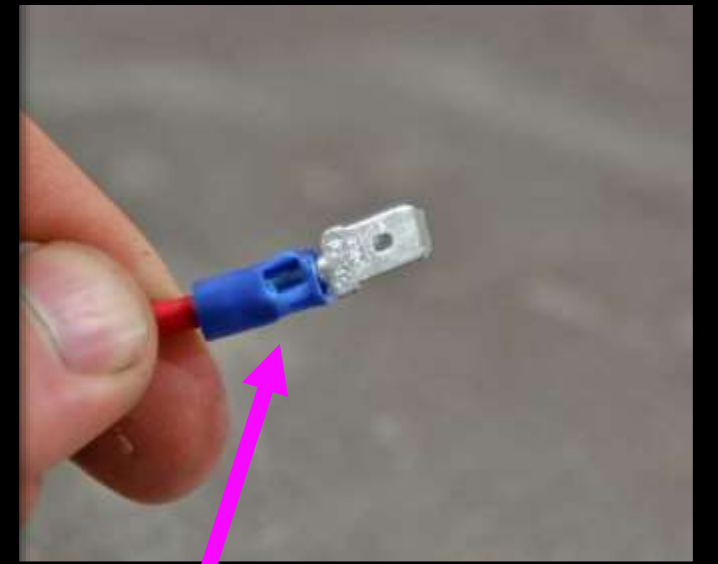

Only one side of the crimp should be compressed, and which side depends on the terminal. Use online tutorials for specific types.

# Wiring

## Multimeter

- An electronic measuring instrument that combines several measurement functions in one unit.
- Typical multimeters can measure voltage, current, resistance and continuity. Some units can also measure capacitance.
- In FRC, you will mostly be concerned with continuity and making sure the chassis is electrically isolated from the battery.
  - >3k Ohm between PDP input posts and chassis



# Wiring

## Chassis Isolation Test

Prior to competition, a robot inspector will check to see if your chassis is electrically isolated from it's battery. By following the simple steps listed outlined below you can perform your own check and lessen any chances of surprise issues during inspection.



1. Switch multimeter to "Ω" ohm symbol to measure resistance



2. *With battery removed*, turn on main breaker switch

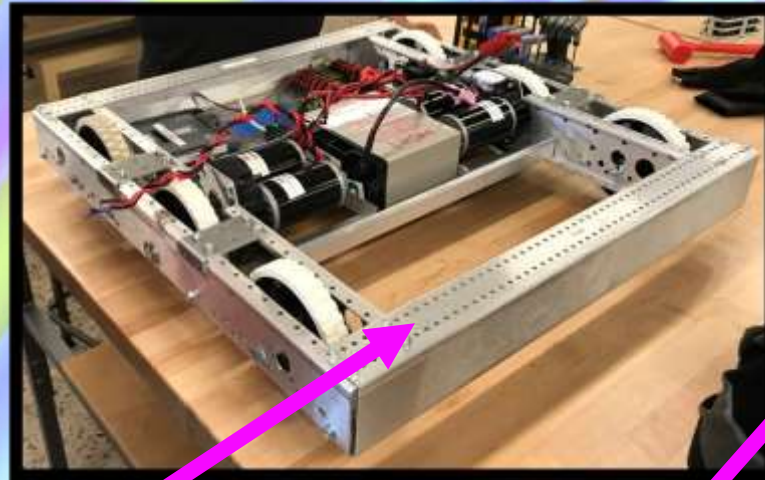

3. Touch one probe to an unpainted surface of the of the metal chassis frame



4. Touch other probe to each of the power posts on the PDP. *Readings should be below >3k ohm per the rules*

If you find a problem, try checking wire insulation, particularly at terminals or anything wrapped in tape. It only takes single stray strand of wire to cause an issue. **Always find the root cause.** **Problems that "magically go away" will come back to haunt you at the worst possible times.**

# Wiring

## Ferrule Crimpers

- **Metal tube crimped over stranded wire to secure the strands within a screw terminal or Weidmuller Connector**
- **Plastic insulation protects exposed portion of the wire not completely inside the screw terminal post.**
- **Keeps strands together making the wire easier to install.**

Although they are not necessary, insulated ferrules make stranded wire installation cleaner and easier, when done properly. This is particularly helpful on components that feature Weidmuller Connectors, such as the Pneumatic Control Module (PCM) and the Voltage Regulator Module (VRM).

*ProTip: Whether ferrules are used or not, one thing that should never be done is to tin the wires with solder. This practice actually interferes with the formation of mechanical wire connections and results in solder debris being deposited in the connectors.*

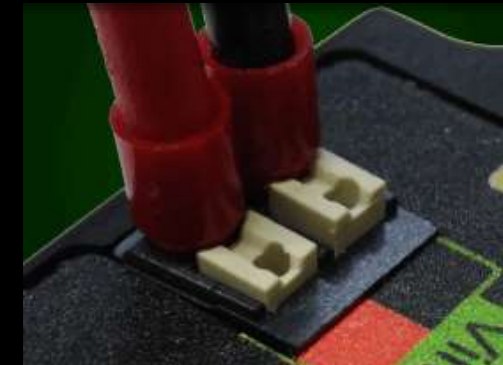



# Wiring

## Soldering Equipment

- Process of joining together metal items with a filler metal, which is melted and applied to the joint.
- Ideal for through-hole soldering custom circuits on perfboard or protoboard.
- Successful soldering relies on thorough flow of molten solder to the joint through capillary action.
- Forming good crimped mechanical connections is preferable in FRC for workability reasons. Wire to wire soldering should be more of a last resort.





# Wire and **Cable**

# Wiring

## Wire Gauge

- A measurement of wire diameter using the unit American Wire Gauge (AWG).
- Sizes range from 0 to 40, going from largest to smallest.
- FRC sizes run from 4 or 6 AWG for battery cables, all the way up to 22 AWG for CAN wires.
- If a wire is hot to the touch, it may be not be a big enough gauge for the load. Don't be afraid to go bigger if necessary.

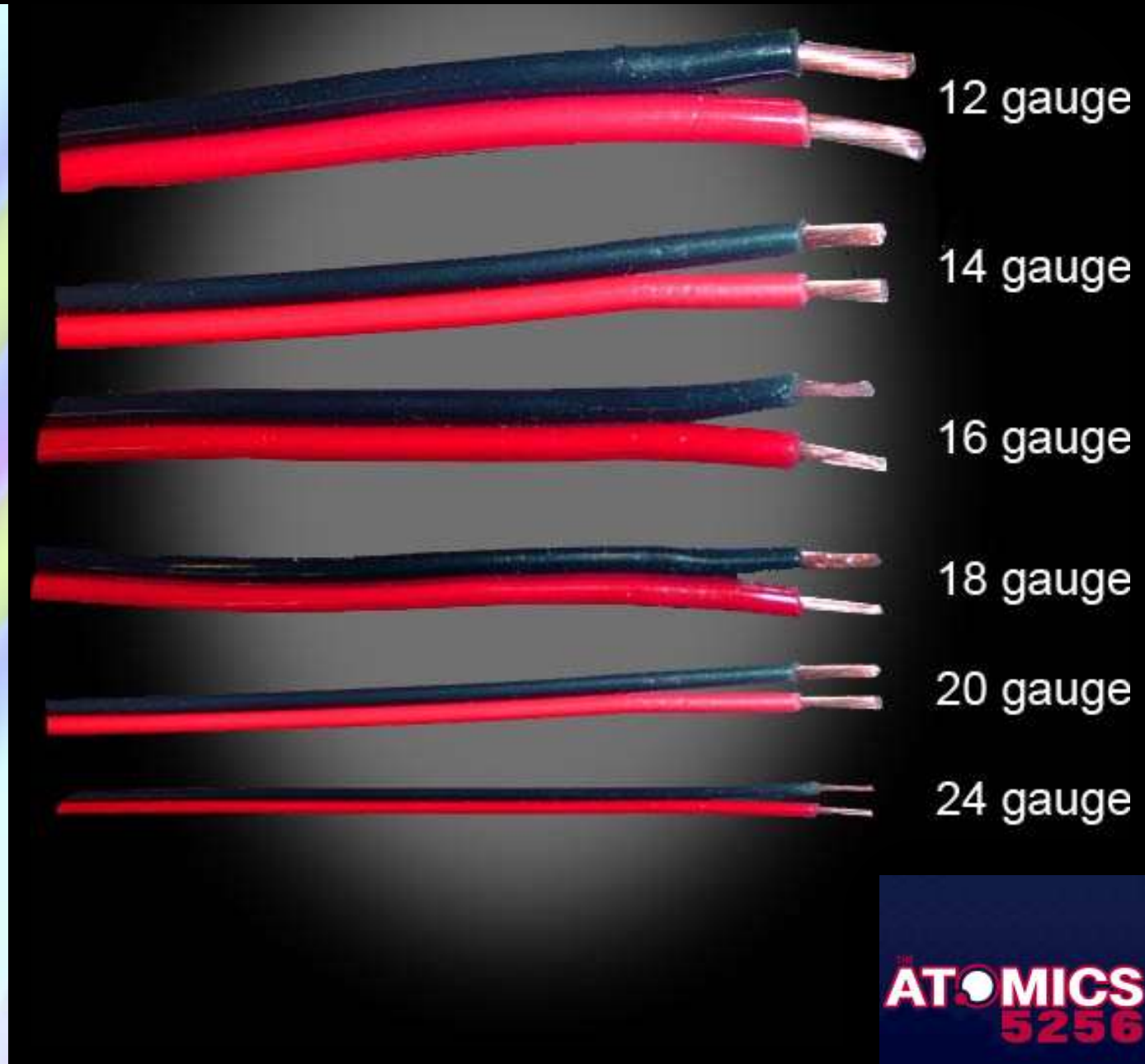

# Wiring

## Solid Wire

- **Single conductor**
- **Composed of a single piece of metal wire, also known as a strand.**
- **Used when little or no movement is needed.**
- **Ideal for through-hole soldering as well as use with breadboards and Arduino boards.**
- **Household wiring (THHN, Romex) is solid.**

The problem with solid wire is that it will eventually break if flexed repeatedly. Even something non-actuated, like a motor controller, is subject to regular maintenance and adjustments, which results in bent wires and can lead to failures over the course of the season.

Solid wire is perfect for working with something like the perfboard or Arduino and breadboard shown at right.

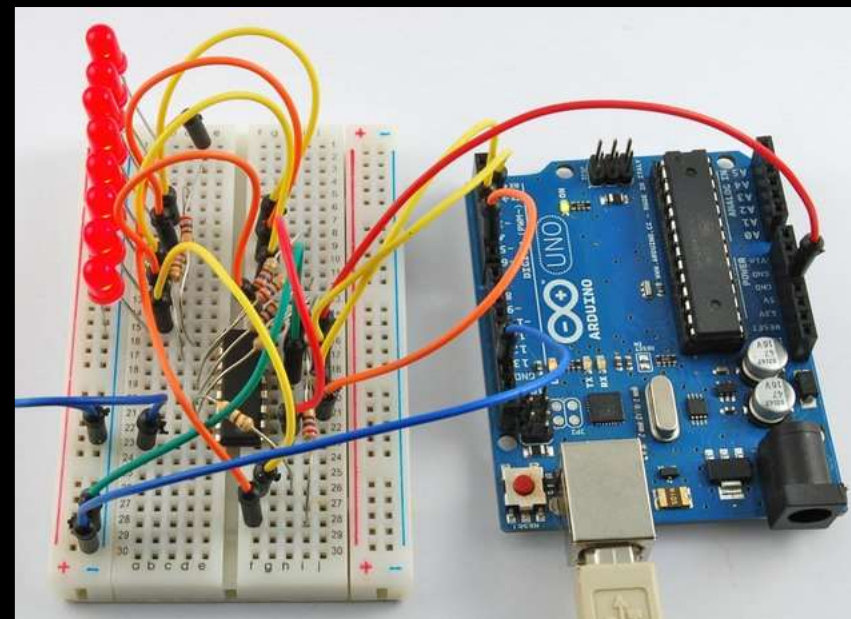
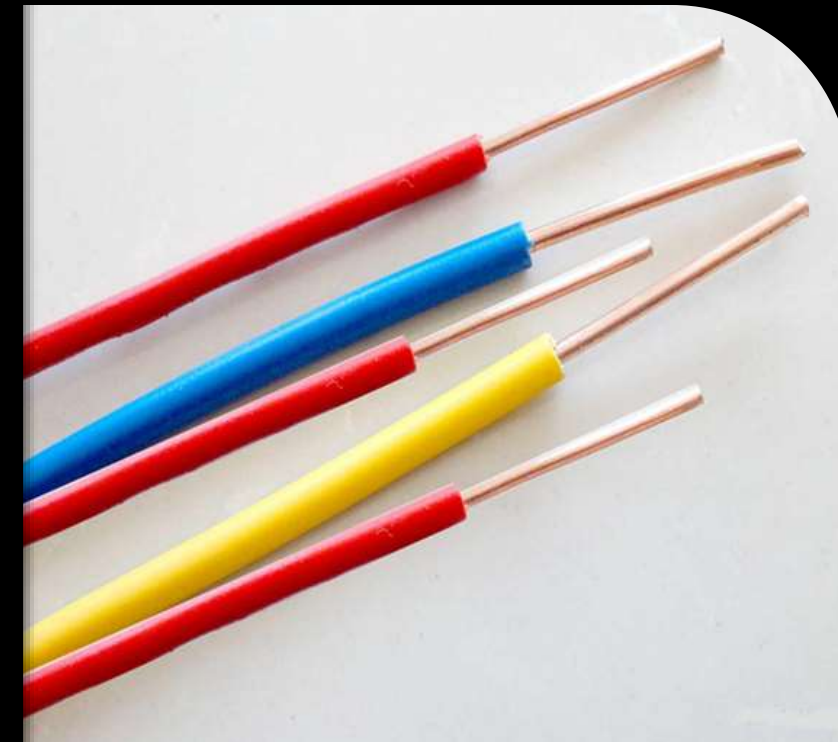
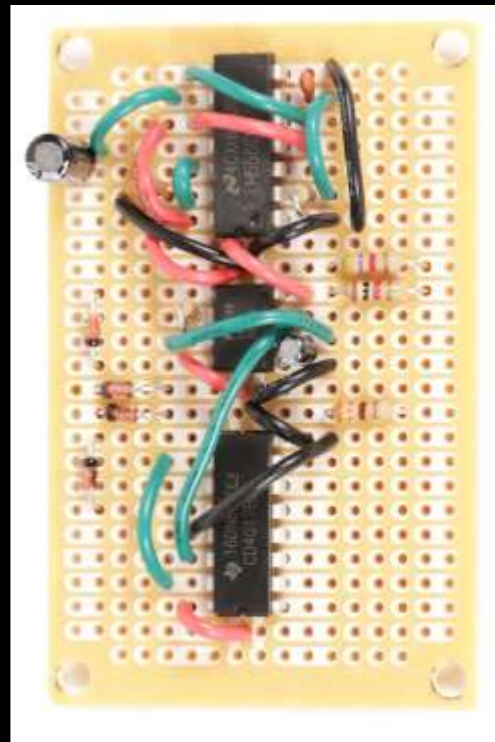

# Wiring

## Stranded Wire

- **Single Conductor**
- **Composed of many pieces of solid wire all bundled into one group.**
- **Used when the wire needs to move around frequently, such as in a robot arm.**
- **Designated by 3 numbers:**
  - Overall AWG size, Number of strands, and AWG size of each strand
  - For example, a 22 AWG 7/30 stranded wire is a 22 AWG wire made from seven strands of 30 AWG wire.

Stranded wire is the standard for machine and robot wiring due to its flexible nature. It's made up of several smaller individual strands of wire, instead of one single larger strand, making it much more supple, and thus more durable, than solid wire.

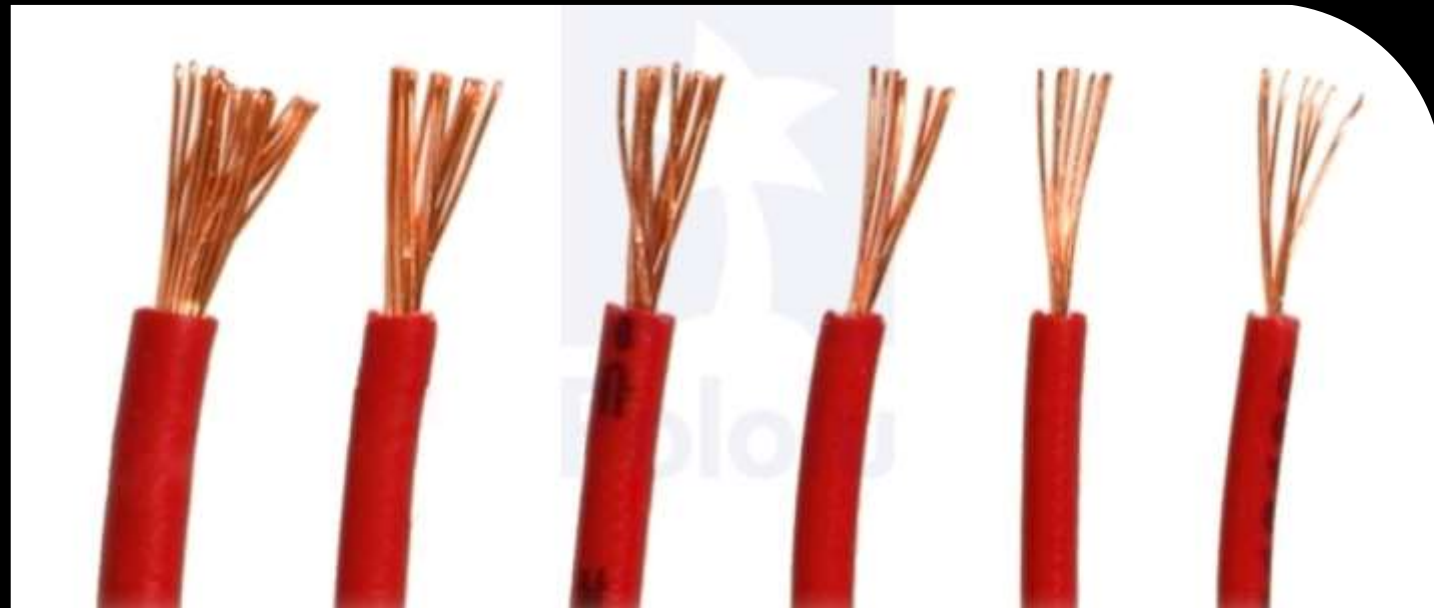

# Wiring

## Cable

- Made up of 2 or more separate conductors.
- Can be side-by-side (ribbon cable), twisted, bonded (zipcord), or bundled.
- May use solid, stranded, braided, insulated, bare, or any combination of wire types and gauges.

Cables are assembled from multiple insulated wires. This includes everything from heavy gauge 240V extension cords to delicate 3.3V signal wire.



USB 2.0 Type B

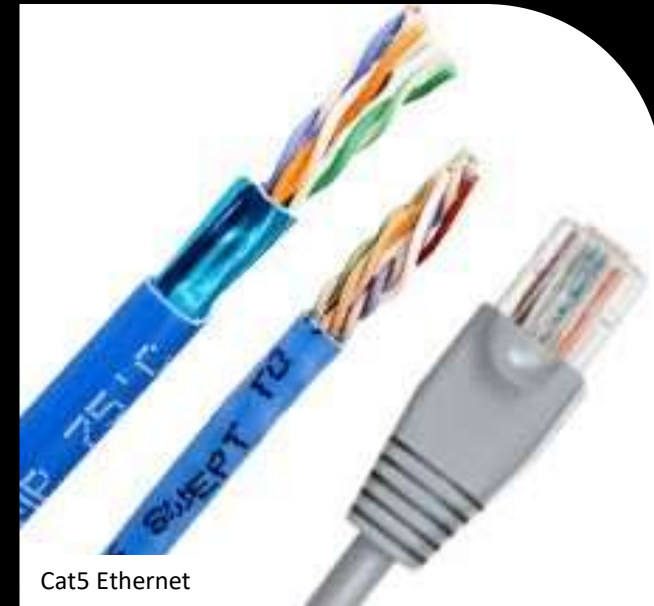

Cat5 Ethernet

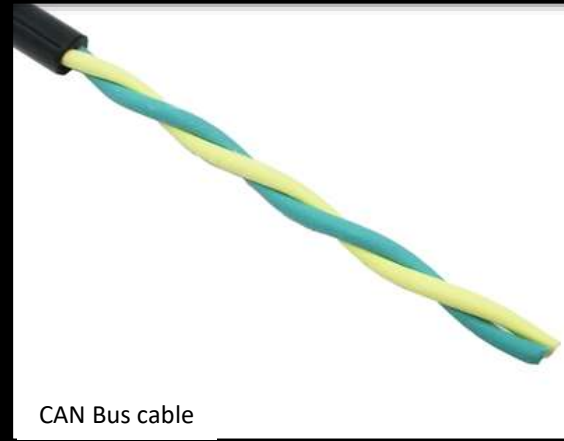

CAN Bus cable

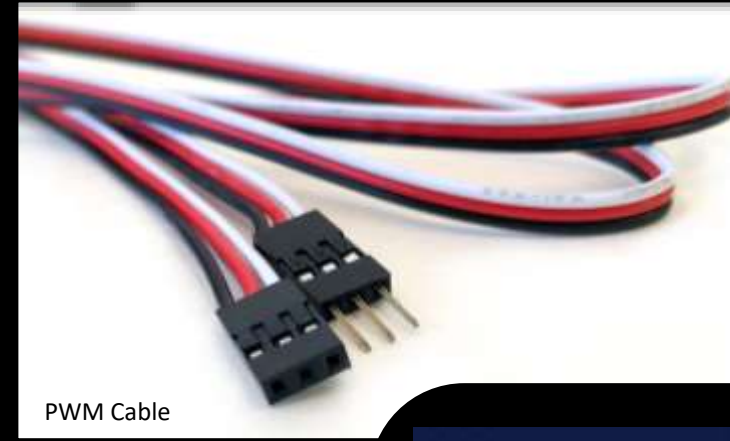

PWM Cable



Bonded wire (zipcord)



CAN Bus twisted pair



SRX data cable

# Wiring

**If you remember only one thing from this section...**

For prototypes, breadboards, and custom circuits where wires are not subject to flexing.



For all robot component wiring, from the battery cables to the entire control system.

**Do Not Wire Your  
Robot with Solid Wire**



# Terminals and **Connectors**



# Wiring

## Spade Connectors

- Used for removeable connections.
- Some are fully insulated and others are not.
- Cheap and readily available at hardware and big box stores

Spade connectors fall into the category of the quick and dirty option. They do the job, they're cheap, and you can get them nearly anywhere. They are not pretty when crimped and often break if too much pressure is used. Also, it's often a challenge to stuff 10-12 AWG wire into the proper sized terminal.

Still, with a good crimp and some heat shrink tubing to clean things up, spade terminals can work.



Insulated Female-only Spade Connector



Female Spade Connectors



Insulated M/F Spade Connectors



Male Spade Connectors



Properly crimped connectors

# Wiring

## Anderson Powerpoles

- Crimp-on metal conductors designed to snap into a plastic housing.
- Housings have slots and tabs to slide multiple connectors together into a single plug. Clips are available to keep them seated.
- Conductors available in 10-14 AWG, 12-16 AWG, and 16-22 AWG.
- Plastic housings available in black, red, green, yellow, white, and blue.

Anderson powerpoles offer a high-quality, insulated connection for wire runs, but are not without a few drawbacks. They can be expensive and time consuming to assemble. In addition, they can come unplugged and wires loosen if poorly crimped. However, when done right, they are very reliable



# Wiring

## XT60/XT90 Connectors

- Polarized soldered connectors used in RC.
- Cannot be plugged in backwards.
- Gaining popularity in FRC as an alternative to powerpoles
- XT60 rated for 60A continuous; XT90 rated for 90A continuous.

Made from high-temp nylon with gold-plated spring pins or sockets molded in. The shape prevents reverse polarity, and when plugged in the connection is super-solid.

Unlike powerpoles, this connector is already assembled. All that is needed is for wires to be attached. Solder cup connection is simple for novices and produces great results.



1. Place heat shrink on wire away from heat.
2. Fill one solder cup with solder.
3. Insert wire into molten solder.
4. Repeat
5. When cool, Slide heat shrink over joints so it goes into XT60 and heat.

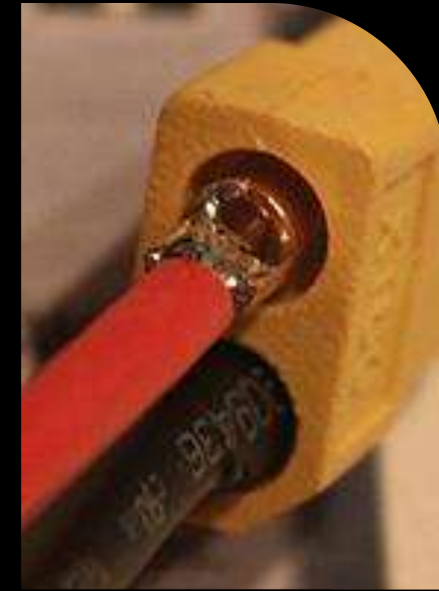

# Wiring

## Wago Lever Nuts

- Created to be an alternative to wirenuts for easy splicing.
- Insert a stripped wire and lock into place with the lever.
- Most not rated for currents over 40A, so be mindful of the ratings.





Anyone who has ever tried to connect different types and gauges of wires with traditional wirenuts knows how frustrating it can be sometimes. Lever Nuts make splices like these super easy and result in a secure connection able to handle the rigors of FRC.

Lever Nuts also make for a good fix in the pits if something comes loose at the last minute.



# Section 13: Wiring

## Skills

-  Correctly insert wires into Wago and Weidmuller connectors.
-  Crimp reliable connections with Powerpole, spade terminals and ferrules.
-  Learn to test for resistance and continuity using a multimeter.
-  Strip wires without damaging them.

## Review Questions

1. Which wire type is most flexible?
2. Why are cable and wire different?
3. Why is solid wire bad for control system connections?
4. What unit is used for wire size?
5. How do you crimp Lever Nuts?

## Section 14

# Sensors & Inputs



Potentiometers  
and  
**Switches**

# Sensors

## Limit Switches

- Probably the easiest of all of the sensors is the limit switch
- Typically implemented as a simple switch attached to actuator that indicates that you've reached some end condition
  - Switch can be Normally Open or Normally Closed depending on your logic in the software.



### TL, DR:

Most motors just move things and don't know how far is too far, which tends to break things. By having the moving thing hit a limit switch we can send a signal to tell when to stop the motor from going too far.

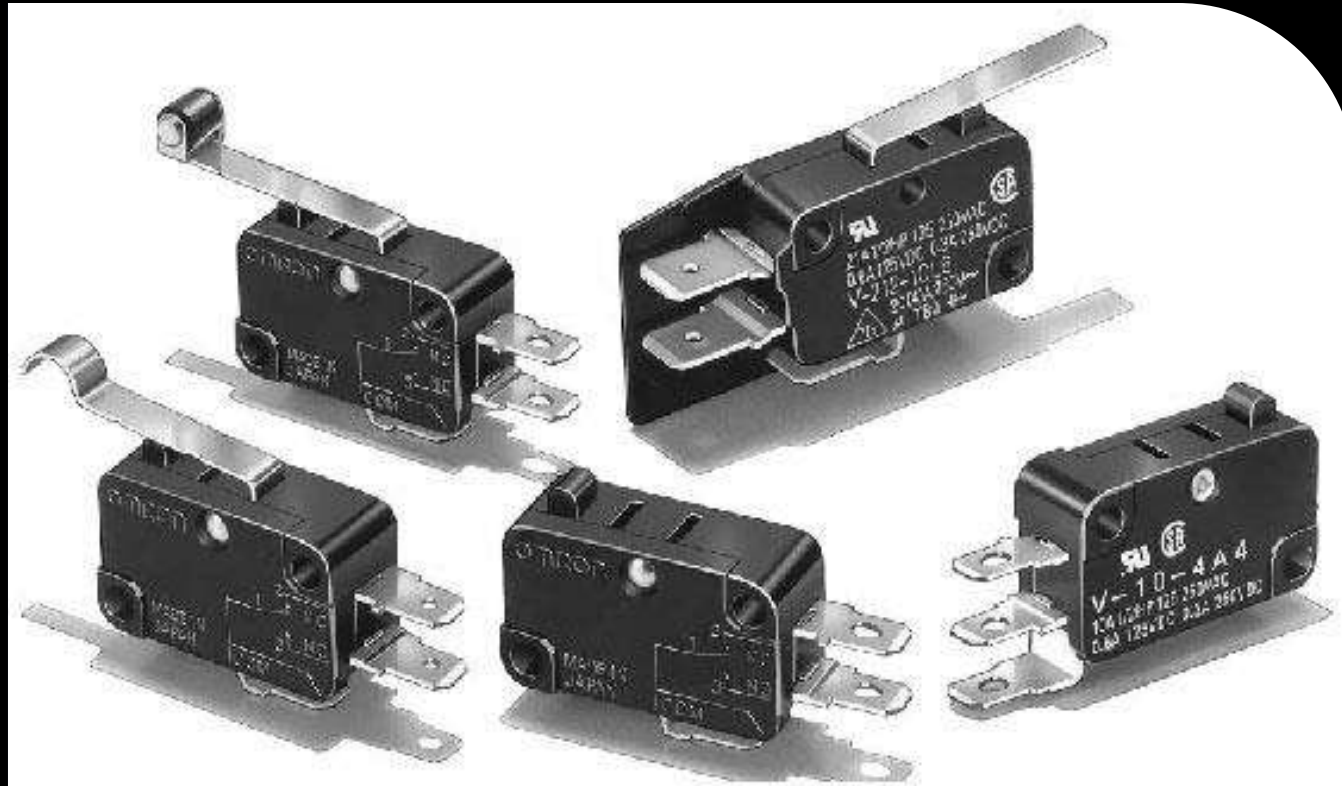

**ATOMICS**  
5256



# Sensors

## Pneumatic Pressure Switch

- The Pneumatics Control Module has a built-in interface for the pressure switch used with the pneumatics sub-system on the high-pressure side
  - Automatic cut-off of compressor when pressure gets to a certain value.



### TL, DR:

Senses air pressure and tells the compressor to shut off before stuff goes boom.

Also tells it when to turn back on when pressure gets low.



# Sensors

## Auto Selection Switches

- Often in autonomous mode we will need to select different plays based on our alliance partner's capabilities
  - Can use a series of digital inputs and toggle switches, but this eats up DIOs
- Often this is accomplished using rotary switches with resistor ladders.
  - Use the analog input to measure which switch position is selected
- Team 5256 has typically used a series of 2-3 toggle switches in the past with different combinations of on/off determining which autonomous routine to run before a match.

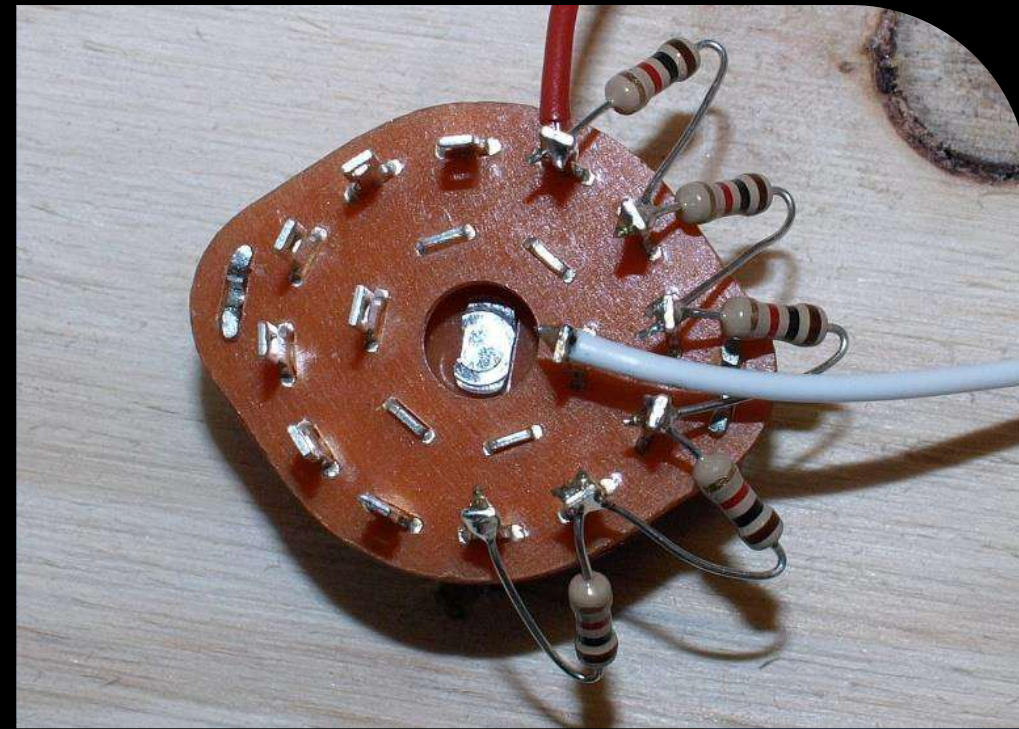

# Sensors

## Position Sensors

- Position sensors often take the form of a potentiometer attached to a linkage
- Potentiometers are generally an analog sensor
  - The means you'll connect it to the analog inputs on the RoboRio
- Usually, a potentiometer has 3 wires
  - VCC, GND and a signal return
- The analog input of the RoboRio has a 12-bit resolution.
  - 0-4096 range and you can use the value to calculate an approximate position in space based on the measured return voltage.

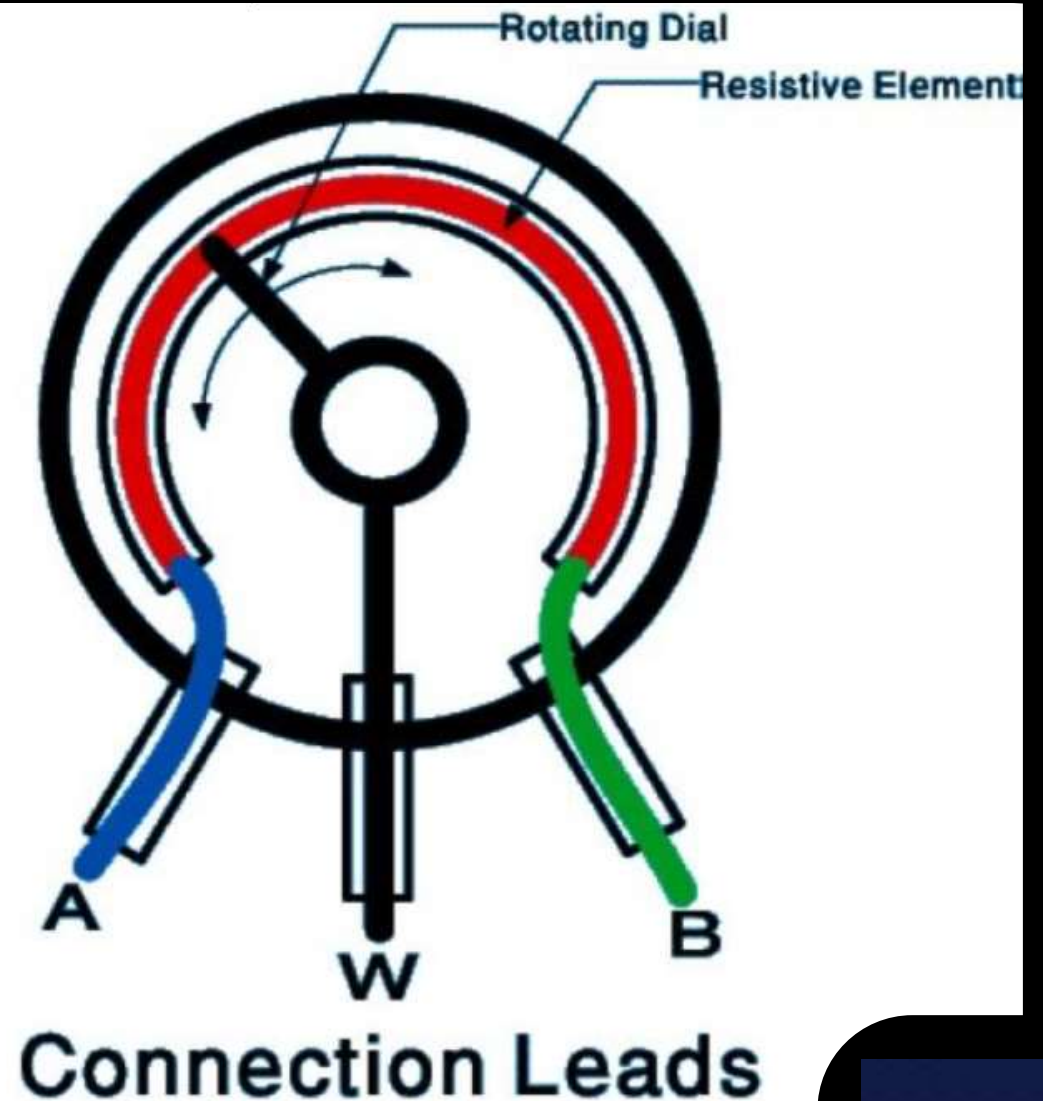

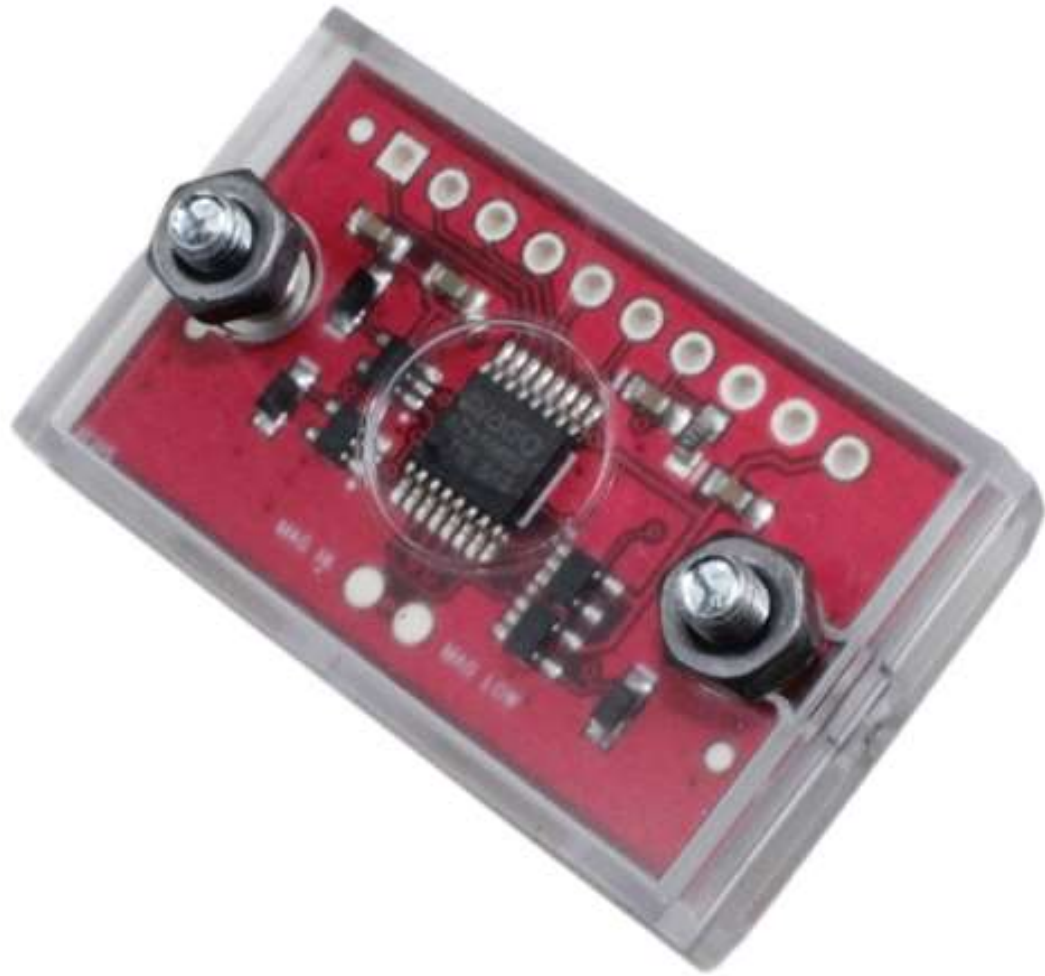

# Encoders

# Sensors

## Rotary Encoder

- These encoders will have a number of pulses per revolution
  - Given the diameter of the attach point, you can determine how far the system has moved based on the number of pulses
  - Can also be used as a tachometer
- Make sure you purchase the encoder rated for the speed you're trying to measure
- Like the Hall-effect sensor, high PPR can burden the RoboRio
  - Hook up to a DIO and declare the DIO a counter



### TL, DR:

Imagine putting a piece of red tape on one spoke of a bicycle wheel. Now, spin the

wheel and count every time it makes a complete revolution. That's basically what all encoders do.





# What is the Hall Effect?

The Hall effect is the production of a voltage difference across an electrical conductor, transverse to an electric current in the conductor and to an applied magnetic field perpendicular to the current.

## Ok, but what does this mean?

1. When an electric current flows through a material, electrons move through it in pretty much a straight line.
2. Put the material in a magnetic field and they deviate from their straight-line path.
3. Now looking from above, the electrons in this example would bend as shown. With more electrons on the right side of the material than on the left, there would be a difference in potential voltage between the two sides, as shown by the green arrowed line.

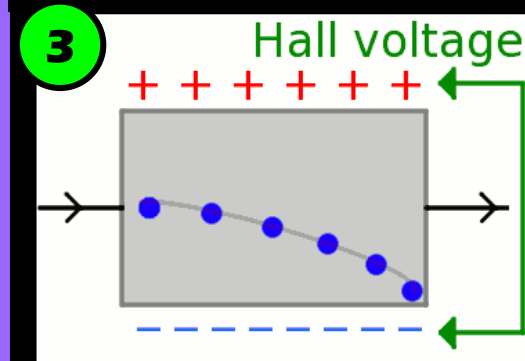
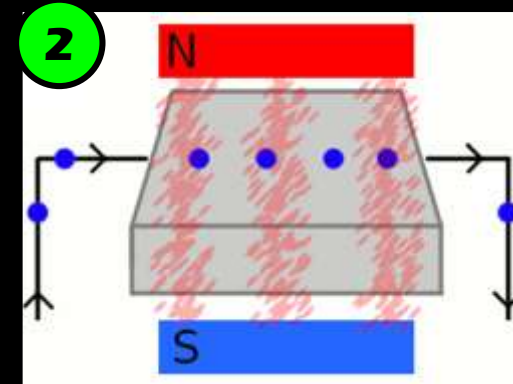
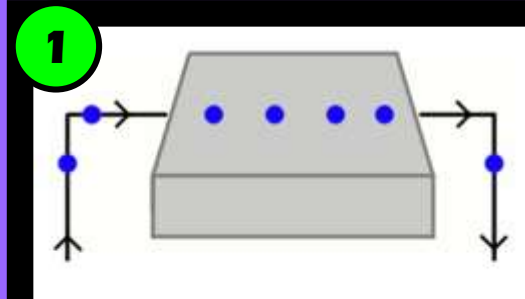

**Edwin Hall**  
Discoverer of the Hall Effect

**Using Hall Effect Sensors we can do lots of cool stuff! Read on...**

# Sensors

## Hall Effect Sensors

- Hall-effect sensors use metal moving through a magnetic field (induction) to indicate motion
  - Can also be used as a limit switch (This is what we used on our 2018 elevator)
- Can be used to count rotations or calculate position based on the number of gear teeth that have passed the sensor
- Can also be used as a tachometer



### TL, DR:

Magnetic fields change the flow of electrons, which we can detect with sensors. This allows us to use magnets in limit switches and encoders.

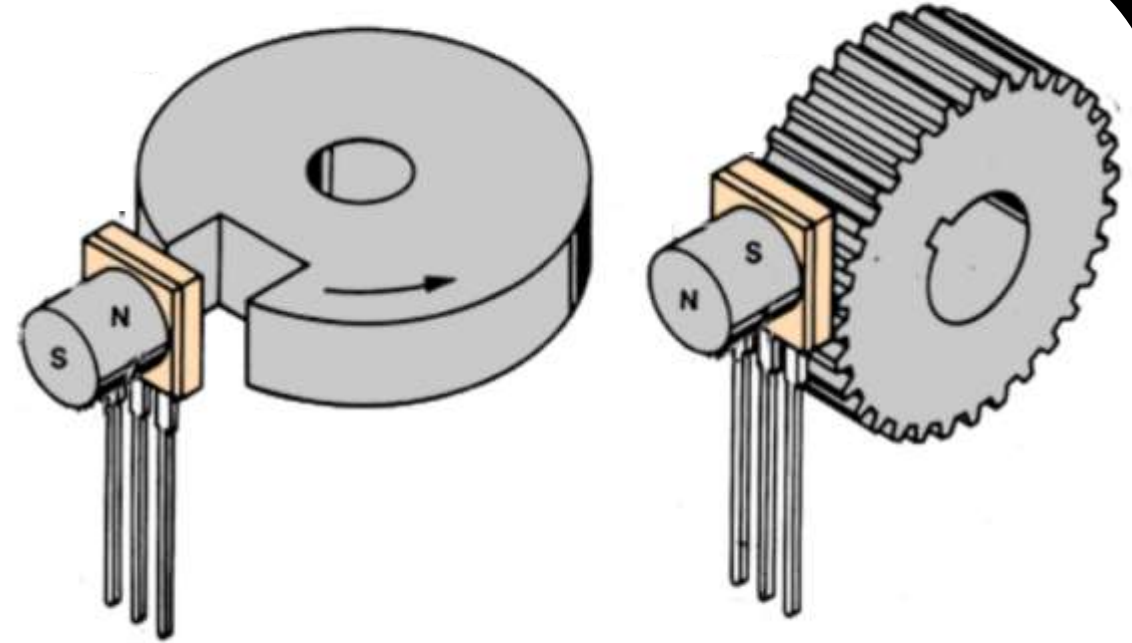

# 'Memba this brushless boi?

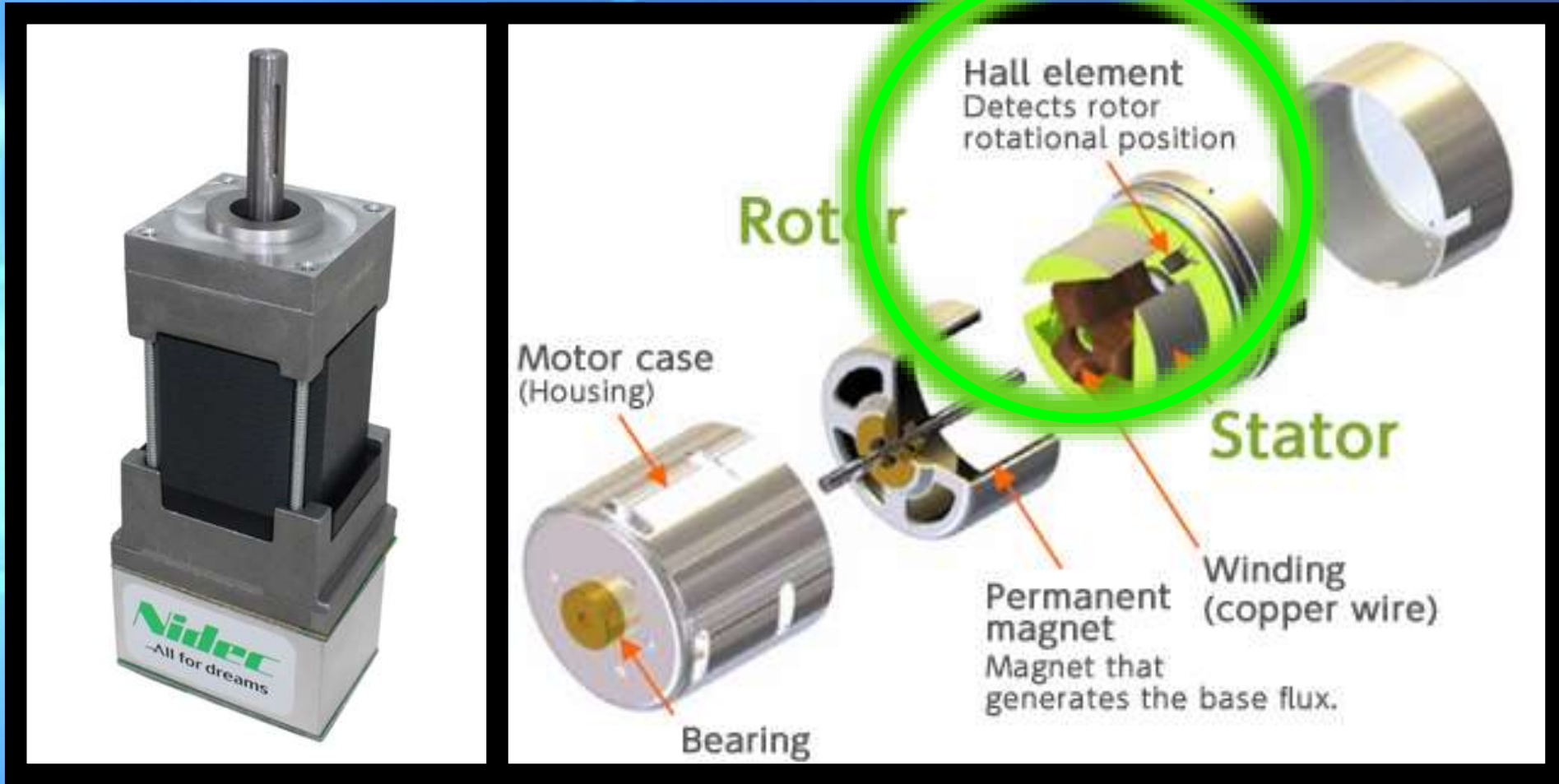

**He's got a Hall Effect sensor too!!1**



# Sensors

## Quadrature Encoder

- These are similar to the rotary encoder except that you can determine forward vs. reverse motion
- Usually a “quad shaft encoder” is attached to the axle of a wheel
  - Many gear boxes have specific mounting points for quadrature encoders
- Given the diameter of the wheel, you know how far it's moved based on the number of pulses



### TL, DR:

Quadrature encoders count rotations, but send different signals when going forward or reverse. This makes them more accurate.

## Quadrature

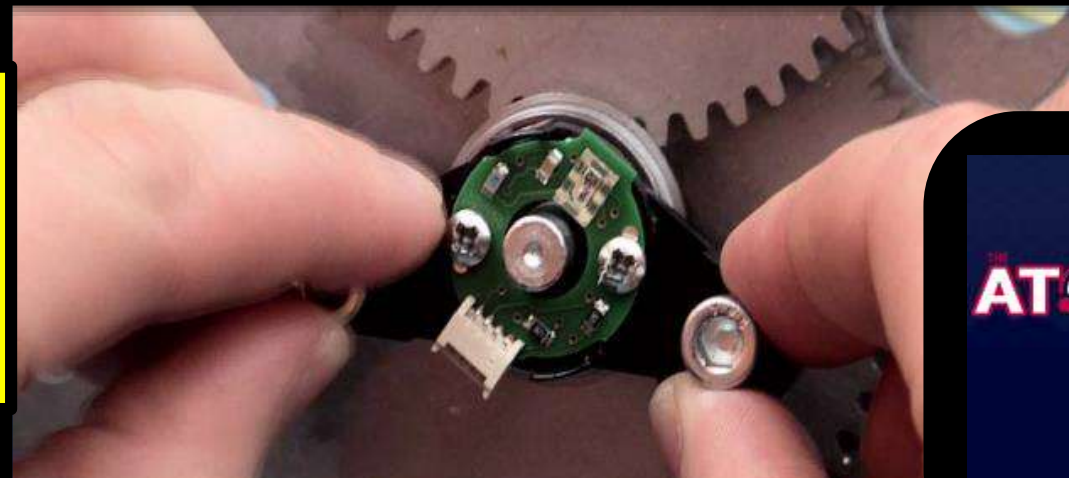
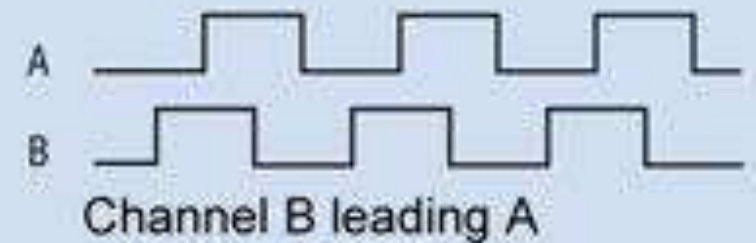
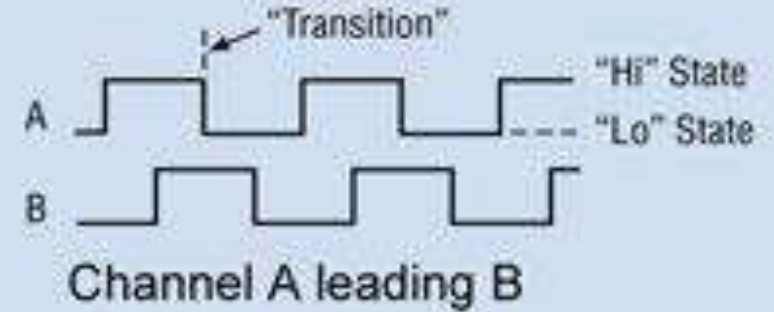

# Sensors

## SRX MAG ENCODER

- Magnetic rotary encoder by CTRE that plugs into the Talon SRX
  - Supports closed loop operation with the Talon SRX
- Can be used for absolute or relative position sensing as well as velocity
- The encoder senses the magnetic field of a diametrically polarized magnet to determine rotational position with 12-bit accuracy
- Provides Quadrature interface that can be used for relative positioning and a PWM output for absolute position measurement





# Closed-Loop Control Systems

Sensors are vital for measuring and monitoring process output so it can be compared with a desired setting to reduce error and, when necessary, bring the output of the system back to the original setpoint.

That sounds complicated, but think of your furnace thermostat: You set it to the temperature you want and it produces heat until it reaches the desired temp and then turns off. When it begins to get too cold, it turns back on until it reaches the temp again. This is how it maintains a temperature in your home.

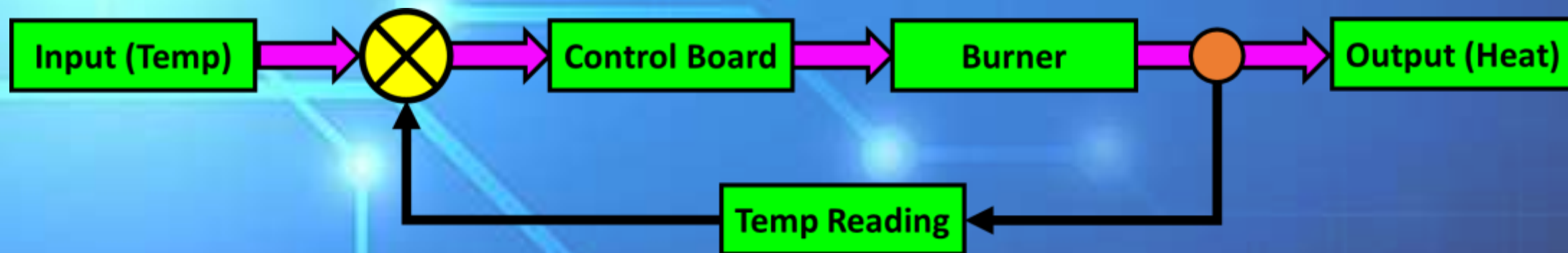



# Distance Sensors

# Sensors

## Ultrasonic Sensor

- This unit uses sonar to determine distance to an object.
- Not affected by sunlight or black material.
- Sensitivity and beam patterns vary widely between models.
  - Some have shorter ranges of just a few inches for proximity detection.
  - Others can reach several feet for range finding.
- One of the most common and inexpensive sensors for distance detection.



# Sensors

## LIDAR

- This unit uses a LASER to measure distance.
  - A pulse is emitted and a measurement is taken of how long it takes to return.
- FIRST restricts the power and type of LASERs on the robot
  - Must be Class 1 LASER, typically in the near IR spectrum
    - It's invisible to the human eye, but your cell phone camera can see it
- 360° Sweep LIDAR can be used to adapt to settings in autonomous routines
- Very accurate and very fast distance acquisition



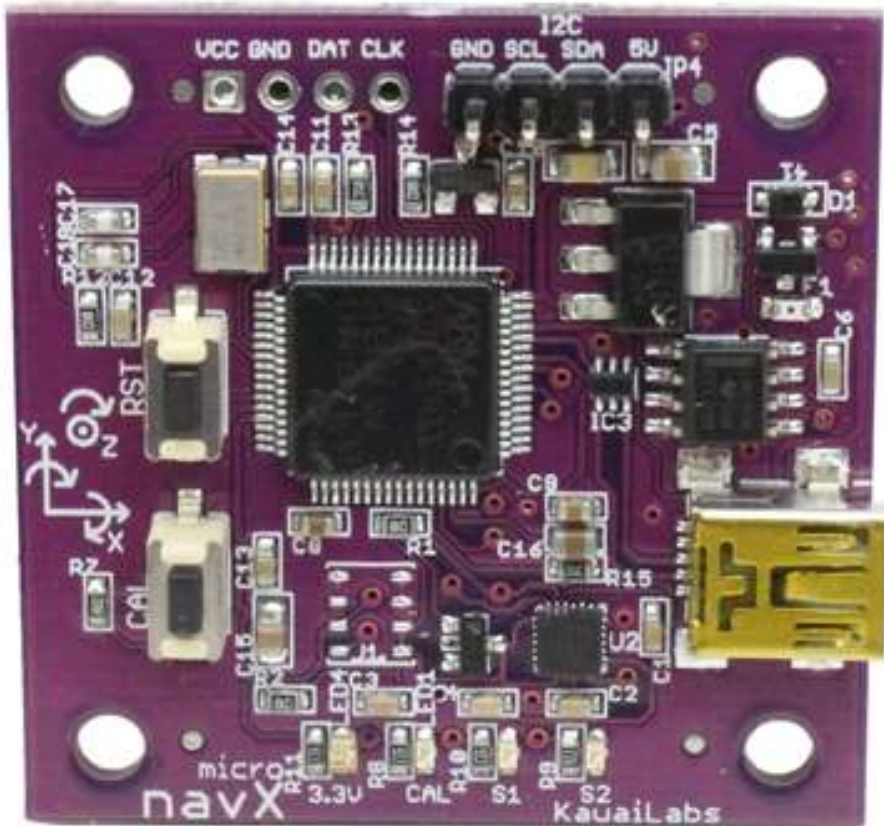

# Position Sensors

# Sensors

## Gyroscope

- Measures the rate of turn
- Has some major drawbacks as a standalone sensor:
  - Subject to drifting (loses accuracy)
  - Can be off by quite a bit after multiple hard hits by other robots
- Works best when combined with multiple position sensors.





# Sensors

## Magnetometer

- Also known as a digital compass.
- Reads an absolute measurement of direction relative to magnetic north.
- Biggest drawback is sensitivity to interference from large magnetic fields (like motors).
- Works best when combined with multiple position sensors.

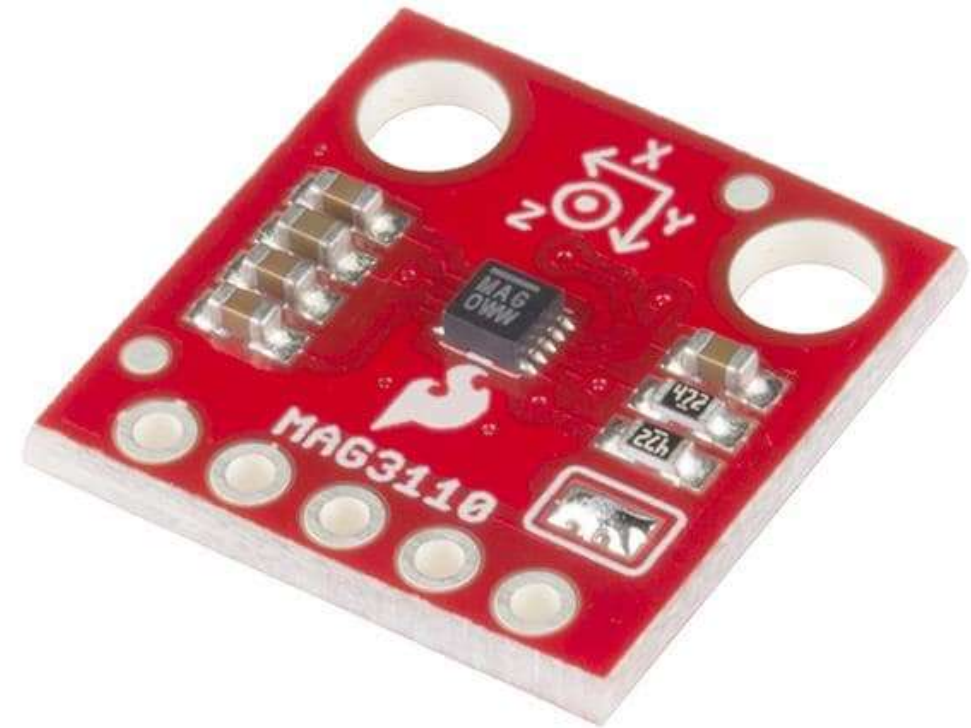

# Sensors

## Accelerometer

- Measures acceleration or vibrations in terms of “G”s
  - Normal gravity at sea level is defined to be 1G.
- Can be used to detect tilt.
- Can also be used to detect impacts and make adjustments to the gyro to correct for drift.
- The RoboRIO has a built-in 3-axis accelerometer.
- Works best when combined with multiple position sensors.

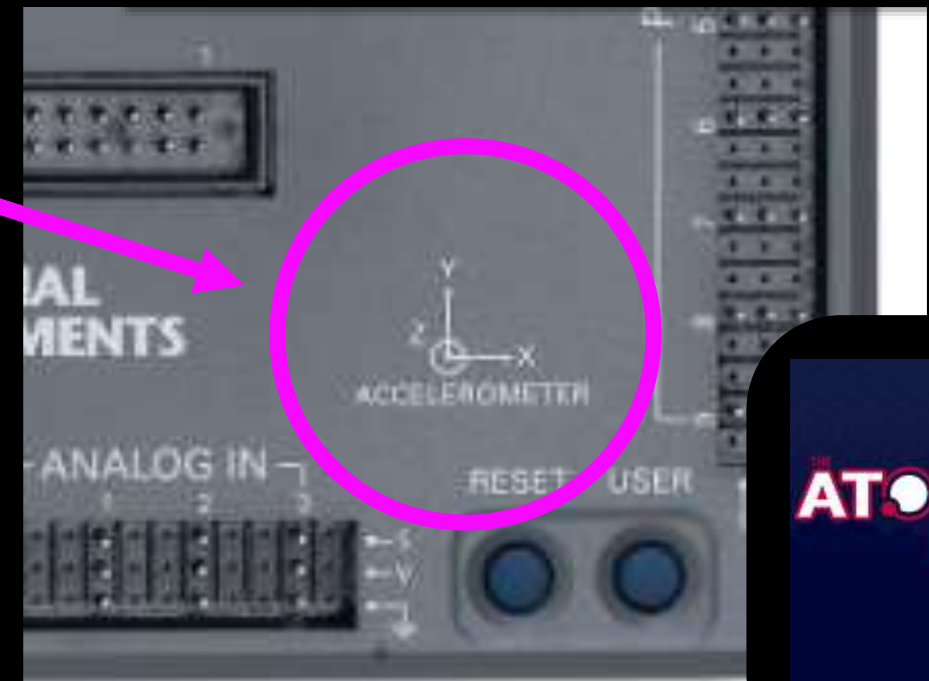

# Teamwork Makes the Dream Work

No single position sensor is a standalone navigation solution and what to do about it.



## Gyroscope

Senses turns and rotation

Cannot reorient itself when it suddenly changes direction after taking hits on the field, making its readings inaccurate.

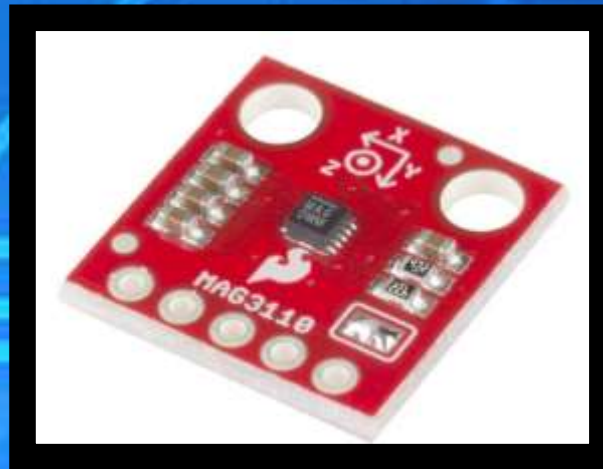

## Magnetometer

Acts as a compass

Able to locate itself in relation to magnetic north, but not which way it is pointed or whether it is flipped over or on an incline.



## Accelerometer

Detects changes in velocity

Has some overlapping capabilities with gyroscopes, making it ideal for creating more accurate navigational data.

**What if there was an all-in-one solution featuring these sensors?**

**Read on...**

# Sensors

## Inertial Measurement Units (IMU)

- Combines the gyro, accelerometer and magnetometer sensors together.
  - Compliments the features of each sensor, while compensating for their drawbacks.
- Allows you to know where your robot is in the physical world and allows for precise navigation
  - Used frequently in drones
- With an IMU, it's relatively easy to maintain a heading even when getting hit by other robots
- Nav-X IMU mounts directly onto the RoboRIO, interfaces via MXP Connector (as shown at right).





# Machine Vision & **Cameras**

# Sensors

## USB Webcam

- Often used to stream video from the robot back to the drivestation.
  - Can use a fair amount of the allotted bandwidth depending on resolution and framerates.
- Also used for machine vision using software such as OpenCV.
  - Will require additional hardware such as a co-processor and lighting (usually a green LED ring).



# Sensors

## COTS Machine Vision Solutions

### JeVois Smart Machine Vision Camera

- Combines a video sensor, quad-core CPU, USB video and serial port in a very small and inexpensive open source package.

### Limelight

- A plug-and-play smart camera purpose-built for FIRST Robotics Competition
- Designed for teams with no vision experience or expert mentors

### Pixy CMUcam5

- Fast vision sensor designed to simplify machine learning (Can be taught to identify specific objects with relative ease)
- Requires a coprocessor (Arduino, Raspberry PI, Beaglebone or similar controller)

